



2025



# KEY CUSTOMERS



# INDEX - GENERAL CAT.



**FIR TREE RIVET** \_\_\_\_\_ **A01**



**PUSH TYPE RETAINER** \_\_\_\_\_ **B01**



**SCREW GROMMET & NUT** \_\_\_\_\_ **C01**



**PLASTIC U-TYPE NUT** \_\_\_\_\_ **D01**



**PLASTIC BLIND RIVET** \_\_\_\_\_ **E01**



**CONNECTOR** \_\_\_\_\_ **F01**



**CABLE TIE** \_\_\_\_\_ **G01**



**CABLE & TUBE CLIP** \_\_\_\_\_ **H01**



**HOLE PLUG BUTTON** \_\_\_\_\_ **I01**



**DOOR TRIM PANEL CLIP** \_\_\_\_\_ **J01**



**WEATHERSTRIP RETAINER** \_\_\_\_\_ **K01**



**LOCK ROD CLIP** \_\_\_\_\_ **L01**



**HOLE SEAL CLIP** \_\_\_\_\_ **M01**



**SIDE MOULDING CLIP** \_\_\_\_\_ **N01**



**EXTERIOR DOOR SIDE MOULDING CLIP** \_\_\_\_\_ **O01**



**INTERIOR TRIM CLIP** \_\_\_\_\_ **P01**



**INSTRUMENT & SIDE PANEL CLIP** \_\_\_\_\_ **Q01**



**WINDOW RETAINER** \_\_\_\_\_ **R01**





**PILLAR TRIM CLIP WITH METAL SPRING** \_\_\_\_\_ **S01**



**WINDOW & ROOF DRIP CLIP** \_\_\_\_\_ **T01**



**GRILLE CLIP** \_\_\_\_\_ **U01**



**OIL DRAIN PLUG GASKET** \_\_\_\_\_ **V01**



**SEATING CLIP** \_\_\_\_\_ **W01**



**SPECIALIZED PIN** \_\_\_\_\_ **X01**



**SPECIALIZED PLUG** \_\_\_\_\_ **Y01**



**SPECIALIZED RETAINER** \_\_\_\_\_ **Z01**



**METAL SCREW & BOLT** \_\_\_\_\_ **XA01**



**METAL BLIND RIVET** \_\_\_\_\_ **XB01**



**METAL GASKET & WASHER** \_\_\_\_\_ **XC01**



**METAL TRIM PANEL SPRING CLIP** \_\_\_\_\_ **XD01**



**METAL U-TYPE NUT** \_\_\_\_\_ **XE01**



**SPECIALIZED METAL CLIP** \_\_\_\_\_ **XF01**

# INDEX- MODEL No.

<b>C0001-C0050</b>		C0070	B19	C0140	A10	C0209	A10	C0279	G02
C0001	A09	C0071	B14	C0141	B20	C0210	X01	C0280	B14
C0002	A09	C0072	B19	C0142	B20	C0211	Z09	C0281	B15
C0003	A09	C0073	C18	C0143	M05	C0212	N14	C0282	E03
C0004	A09	C0074	C18	C0144	B33	C0213	P02	C0283	B30
C0005	A09	C0075	C18	C0145	B30	C0214	B33	C0284	A10
C0006	M05	C0076	U02	C0146	M04	C0215	B30	C0285	X01
C0007	A09	C0077	M05	C0147	A21	C0216	B21	C0286	C18
C0008	A19	C0078	N15	C0148	B20	C0217	M08	C0287	C18
C0009	M03	C0079	M05	C0149	B33	C0218	Z15	C0288	Z15
C0010	M03	C0080	B19	C0150	A10	C0219	M05	C0289	N09
C0011	A19	C0081	B19			C0220	H07	C0290	X01
C0012	A21	C0082	T03	<b>C0151-C0200</b>		C0221	B21	C0291	K02
C0013	X01	C0083	B20	C0151	A20	C0222	C13	C0292	C13
C0014	U01	C0084	B29	C0152	B20	C0223	A10	C0293	C18
C0015	U01	C0085	B29	C0153	A10	C0224	N15	C0294	C31
C0016	U01	C0086	M05	C0154	G02	C0225	Z12	C0295	N16
C0017	A09	C0087	M05	C0155	A10	C0226	J15	C0296	N16
C0018	B19	C0088	B29	C0156	B20	C0227	N08	C0297	N16
C0019	B33	C0089	B29	C0157	C18	C0228	N08	C0298	C31
C0020	A19	C0090	B29	C0158	B20	C0229	M05	C0299	C31
C0021	A09	C0091	B20	C0159	B14	C0230	C17	C0300	A10
C0022	C31	C0092	B20	C0160	B14	C0231	H10		
C0023	C28	C0093	M05	C0161	E02	C0232	G02	<b>C0301-C0350</b>	
C0024	C12	C0094	M05	C0162	E02	C0233	G02	C0301	A11
C0025	C12	C0095	M05	C0163	A21	C0234	B21	C0302	A20
C0026	C12	C0096	M05	C0164	B20	C0235	B21	C0303	A21
C0027	C23	C0097	B29	C0165	X01	C0236	B21	C0304	I02
C0028	C23	C0098	M03	C0166	J08	C0237	Z09	C0305	I02
C0029	C23	C0099	M05	C0167	A22	C0238	C31	C0306	I02
C0030	C23	C0100	M05	C0168	B14	C0239	E03	C0307	I02
C0031	C17		C0169		B20	C0240	B14	C0308	I02
C0032	C12	<b>C0101-C0150</b>		C0170	A22	C0241	E04	C0309	A11
C0033	C18	C0101	A09	C0171	H10	C0242	A10	C0310	C31
C0034	C18	C0102	A09	C0172	A22	C0243	A10	C0311	Z15
C0035	K02	C0103	A09	C0173	B20	C0244	J08	C0312	X01
C0036	A09	C0104	A09	C0174	A10	C0245	A10	C0313	C13
C0037	A09	C0105	A09	C0175	B20	C0246	A10	C0314	V01
C0038	A19	C0106	C13	C0176	B20	C0247	K02	C0315	V01
C0039	B13	C0107	B29	C0177	C13	C0248	B21	C0316	Z03
C0040	A09	C0108	C23	C0178	B20	C0249	B33	C0317	C13
C0041	B33	C0109	B14	C0179	C13	C0250	H07	C0318	Z03
C0042	A09	C0110	B14	C0180	C13		C0319	B21	
C0043	B13	C0111	B14	C0181	B14	<b>C0251-C0300</b>		C0320	G02
C0044	B19	C0112	N16	C0182	D02	C0251	B21	C0321	B15
C0045	B19	C0113	H10	C0183	C31	C0252	B21	C0322	XF01
C0046	B13	C0114	N16	C0184	T04	C0253	B14	C0323	XF02
C0047	B13	C0115	B14	C0185	L02	C0254	M05	C0324	L02
C0048	D02	C0116	B14	C0186	A10	C0255	J08	C0325	B21
C0049	D02	C0117	B14	C0187	A10	C0256	J08	C0326	A11
C0050	H07	C0118	B29	C0188	B14	C0257	J08	C0327	M04
		C0119	M04	C0189	B30	C0258	J08	C0328	Z08
		C0120	Z15	C0191	N15	C0259	C31	C0329	L02
<b>C0051-C0100</b>		C0121	B14	C0192	B14	C0260	N16	C0330	L02
C0051	H02	C0122	B20	C0193	B14	C0261	N15	C0331	T03
C0052	H03	C0123	B20	C0194	E02	C0262	B33	C0332	Z15
C0053	H03	C0124	X01	C0195	B14	C0263	U01	C0333	B30
C0054	H03	C0125	A09	C0196	Z15	C0264	B33	C0334	B15
C0055	T04	C0126	C12	C0197	C31	C0265	C13	C0335	B34
C0056	J08	C0127	Z03	C0198	A10	C0266	T03	C0336	N09
C0057	C13	C0128	B20	C0199	J08	C0267	C18	C0337	B21
C0058	A09	C0129	C13	C0200	E02	C0268	C31	C0338	B15
C0059	H03	C0130	C13			C0269	C13	C0339	B15
C0060	A20	C0131	A20	<b>C0201-C0250</b>		C0270	J08	C0340	Z15
C0061	J08	C0132	A09	C0201	E02	C0271	J08	C0341	B15
C0062	T02	C0133	B20	C0202	E02	C0272	M08	C0342	N09
C0063	B19	C0134	C13	C0203	E02	C0273	B21	C0343	I02
C0064	J21	C0135	B20	C0204	E02	C0274	B30	C0344	C17
C0065	M03	C0136	B30	C0205	A22	C0275	J08	C0345	N14
C0066	K02	C0137	C23	C0206	A10	C0276	B30	C0346	E03
C0067	J08	C0138	A10	C0207	A10	C0277	B21	C0347	J21
C0068	K02	C0139	A21	C0208	A10	C0278	J08	C0348	N12
C0069	B14								



C0839	C14	C0916	O02	C0994	J10	C1077	B23	C1168	C26	
C0840	C32	C0917	C32	C0995	Z16	C1078	B23	C1169	H08	
C0841	J09	C0918	J22	C0996	C19	C1079	B23	C1170	G03	
C0842	J09	C0919	O03	C0997	B31	C1080	B23	C1171	G03	
C0843	J09	C0920	Z16	C0998	B23	C1081	B24	C1172	C29	
C0844	M09	C0921	Z13	C0999	B23	C1082	B24	C1173	Z16	
C0845	J09	C0922	O02	C1000	C27	C1083	B24	C1174	C32	
C0846	B22	C0923	H07			C1084	B24	C1175	X02	
C0847	O02	C0924	Z16	<b>C1001-C1050</b>		C1085	M04	C1176	X02	
C0848	O02	C0925	B35	C1001	C24	C1086	F06	C1177	B24	
C0849	Z15	C0926	A13	C1002	Y02	C1087	Z16	C1178	B17	
C0850	N08	C0927	Z16	C1003	A13	C1088	N08	C1179	C32	
		C0928	O02	C1004	A13	C1089	N08	C1180	Z16	
	<b>C0851-C0900</b>		C0929	B35	C1005	C14	C1090	N08	C1181	N10
C0851	Z15	C0930	C24	C1006	C14	C1091	N08	C1182	Z16	
C0852	B34	C0931	X01	C1007	A13	C1092	N09	C1183	Z11	
C0853	P02	C0932	O03	C1008	H05	C1093	N09	C1184	C32	
C0854	B34	C0933	C24	C1009	H09	C1096	C26	C1185	C21	
C0855	P02	C0934	B23	C1010	H06	C1097	C32	C1186	J11	
C0856	C29	C0935	J10	C1011	H04	C1098	Z13	C1187	J11	
C0857	N10	C0936	O02	C1012	H04	C1099	D02	C1188	N10	
C0858	A13	C0937	X03	C1013	H05	C1100	D02	C1189	C32	
C0859	F06	C0938	B23	C1014	H05			C1190	C30	
C0860	C14	C0939	J10	C1015	H04	<b>C1101-C1150</b>		C1191	Q02	
C0861	Z15	C0940	H07	C1016	H04	C1101	J10	C1192	H08	
C0862	C23	C0941	Z16	C1017	H09	C1102	Z16	C1193	F06	
C0863	F05	C0942	A13	C1018	H05	C1103	B17	C1194	F06	
C0864	J10	C0943	J10	C1019	H05	C1104	A13	C1195	J11	
C0865	F06	C0944	B23	C1020	H05	C1105	Z16	C1196	Z17	
C0866	A13	C0945	C21	C1021	M08	C1106	N17	C1197	F06	
C0867	M08	C0946	N16	C1022	J10	C1107	B24	C1198	F05	
C0868	F06	C0947	B23	C1023	J10	C1108	H10	C1199	N10	
C0869	B22	C0948	N16	C1024	H05	C1109	J10	C1200	J11	
C0870	F06	C0949	C32	C1025	H05	C1110	A13			
C0871	F03	C0950	C21	C1026	H05	C1111	X02	<b>C1201-C1250</b>		
C0872	K02			C1027	H05	C1112	A13	C1201	Z04	
C0873	J22	<b>C0951-C1000</b>		C1028	H10	C1113	Z01	C1202	Z01	
C0874	F03	C0951	C32	C1029	H10	C1114	J10	C1203	H06	
C0875	Z15	C0952	C21	C1030	H05	C1115	J10	C1204	H06	
C0876	J10	C0953	N16	C1031	Y02	C1119	B31	C1205	H05	
C0877	F06	C0954	C18	C1032	Z10	C1120	Y01	C1206	H06	
C0878	F05	C0955	B31	C1033	Z10	C1121	A20	C1207	H06	
C0879	F05	C0956	B17	C1034	R01	C1122	C24	C1208	H06	
C0880	B22	C0957	B23	C1035	R01	C1123	Z11	C1209	H08	
C0881	F05	C0958	N10	C1036	R01	C1124	C32	C1210	H05	
C0882	B31	C0959	B31	C1037	R01	C1125	C30	C1211	H06	
C0883	B22	C0960	J10	C1038	R02	C1126	Z04	C1212	H11	
C0884	H02	C0961	J10	C1039	R02	C1127	J10	C1213	H08	
C0885	B35	C0962	X02	C1040	R02	C1129	J10	C1214	K04	
C0886	B17	C0963	C24	C1041	I02	C1130	N17	C1215	Z02	
C0887	Q02	C0964	M06	C1042	H05	C1131	A13	C1216	Z02	
C0888	B31	C0965	Z16	C1043	H06	C1132	M08	C1217	C32	
C0889	N10	C0966	Z16	C1044	H10	C1141	Z16	C1218	Y01	
C0891	A20	C0967	C26	C1045	Z16	C1142	Z16	C1219	B35	
C0892	X01	C0968	X03	C1046	G03	C1143	Q02	C1220	J11	
C0893	B22	C0969	N08	C1047	Z01	C1144	T02	C1220DY	J11	
C0894	B35	C0970	Z09	C1048	G03	C1145	M06	C1223	H08	
C0895	C32	C0971	C14	C1049	G03	C1147	B17	C1224	B24	
C0896	D02	C0972	C23	C1050	G03	C1148	Z09	C1225	B24	
C0897	C32	C0973	N16			C1149	N17	C1226	J11	
C0898	D02	C0974	Z16	<b>C1051-C1100</b>		C1150	B24	C1227	A13	
C0899	B23	C0975	M04	C1051	G03			C1228	C14	
C0900	C14	C0976	C19	C1052	Z01	<b>C1151-C1200</b>		C1229	C14	
		C0977	J10	C1053	Z10	C1151	A13	C1230	H06	
	<b>C0901-C0950</b>		C0978	Z16	C1054	Z10	C1152	N10	C1231	H05
C0901	O02	C0979	N16	C1055	R02	C1153	B31	C1232	A13	
C0902	N16	C0980	C29	C1056	Z16	C1154	F06	C1233	A14	
C0903	Z16	C0981	J10	C1057	H10	C1155	H09	C1234	A14	
C0904	O02	C0982	C32	C1058	Z02	C1156	Z01	C1235	A14	
C0905	J22	C0983	Y03	C1059	Z02	C1157	Z01	C1236	J11	
C0906	B35	C0984	XF01	C1060	Z02	C1158	Z01	C1237	A14	
C0907	J22	C0985	P03	C1068	B23	C1159	H02	C1238	A14	
C0908	Z04	C0986	C26	C1069	B23	C1160	F06	C1239	E04	
C0909	O02	C0987	N17	C1070	Y01	C1161	F05	C1240	E04	
C0910	O02	C0988	Y03	C1071	B23	C1162	H02	C1241	E04	
C0911	O02	C0989	J10	C1072	B23	C1163	H09	C1242	E04	
C0912	O02	C0990	A13	C1073	B23	C1164	Z01	C1243	E04	
C0913	O02	C0991	B31	C1074	B23	C1165	H09	C1244	E04	
C0914	O03	C0992	J10	C1075	B23	C1166	Z05	C1245	A21	
C0915	T04	C0993	Q02	C1076	B23	C1167	N15	C1246	A21	



C1247	Z17	C1323	C22	C1400	H03	C1475	E06	C1551	X02
C1248	N10	C1324	B24			C1476	C33	C1552	J13
C1249	J22	C1325	N10	C1401-C1450		C1477	C33	C1553	B25
C1250	J22	C1326	Z17	C1401	J12	C1478	J12	C1554	X02
C1251-C1300		C1327	Z17	C1402	J12	C1479	Z18	C1555	B36
C1251	J11	C1328	Z17	C1403	J12	C1480	Z05	C1556	A14
C1252	H02	C1329	B31	C1404	C26	C1481	J12	C1557	J13
C1253	B35	C1330	C33	C1405	X02	C1482	B35	C1558	X02
C1254	P03	C1331	H08	C1406	Y02	C1483	O02	C1559	X03
C1255	Z17	C1332	H11	C1407	A20	C1484	N15	C1560	Z18
C1256	N19	C1333	G04	C1408	B17	C1485	Z05	C1561	Z06
C1257	P03	C1334	Z17	C1409	X02	C1486	Z05	C1562	C15
C1258	N19	C1335	Z02	C1410	J12	C1487	Z18	C1564	B32
C1259	A22	C1336	Z17	C1411	B35	C1488	B25	C1565	Z18
C1260	P03	C1337	B17	C1412	J12	C1489	N10	C1566	Z05
C1261	N19	C1338	Z17	C1413	M09	C1490	Z05	C1567	Q02
C1262	A20	C1339	J12	C1414	Z17	C1491	Z18	C1568	Z18
C1263	N19	C1340	C14	C1415	Z17	C1492	Z18	C1569	W01
C1264	A14	C1341	C19	C1416	J22	C1493	H11	C1570	W01
C1265	J11	C1342	Y01	C1416A	J12	C1494	F06	C1571	Z18
C1266	C17	C1343	B24	C1417	Z05	C1495	F03	C1572	O03
C1267	B31	C1344	J12	C1418	B24	C1496	Z18	C1573	Z18
C1268	B31	C1345	J12	C1419	B32	C1497	J12	C1574	Z18
C1269	C32	C1346	C33	C1420	B32	C1498	A14	C1575	C30
C1270	N15	C1346B	C29	C1421	B24	C1499	J13	C1576	J13
C1271	N10	C1347	C33	C1422	B35	C1500	J13	C1577	C21
C1272	B17	C1348	Z11	C1423	B35			C1578	C30
C1273	X03	C1349	A14	C1424	Y02	C1501-C1550		C1579	J13
C1274	M06	C1350	C14	C1425	B35	C1501	K02	C1580	B25
C1275	P02	C1351-C1400		C1426	B35	C1502	C27	C1581	B36
C1276	J11	C1351	Z01	C1427	B35	C1503	K02	C1582	B25
C1277	J11	C1352	Z17	C1428	B35	C1504	A14	C1583	J22
C1278	Z17	C1353	N17	C1429	Y02	C1505	K02	C1584	P03
C1279	J11	C1354	Z13	C1430	B24	C1506	C33	C1585	B36
C1280	N10	C1355	O03	C1431	Z17	C1507	B25	C1586	C33
C1281	J11	C1356	B31	C1432	Z05	C1508	Z01	C1587	C24
C1282	Z17	C1357	C33	C1433	Z05	C1509	B25	C1588	C33
C1283	J11	C1358	H10	C1434	Z05	C1510	B17	C1589	Z06
C1284	P02	C1359	B24	C1435	Y02	C1511	B17	C1590	C24
C1285	B24	C1360	J12	C1436	J12	C1512	N15	C1591	J21
C1286	H02	C1361	M04	C1437	H03	C1513	N10	C1592	X02
C1287	J11	C1362	C33	C1438	N09	C1514	Z11	C1593	Z06
C1288	P02	C1363	F03	C1439	Z17	C1515	Z16	C1594	Z01
C1289	C19	C1364	Z02	C1440	Z17	C1516	Z18	C1595	Z18
C1290	X01	C1365	Y02	C1441	Z18	C1517	Z06	C1596	X03
C1291	P02	C1366	R02	C1442	O03	C1518	B25	C1597	B36
C1292	A20	C1367	H11	C1443	O03	C1519	N10	C1598	J13
C1293	A22	C1368	H03	C1444	B24	C1520	A14	C1599	J13
C1294	J11	C1369	R02	C1445	B25	C1521	C19	C1600	X03
C1295	J11	C1370	R02	C1446	A20	C1522	C19		
C1296	A14	C1371	H05	C1447	A20	C1523	N10	C1601-C1650	
C1297	P02	C1372	R02	C1448	B17	C1524	N11	C1601	A14
C1298	J11	C1373	R02	C1449	B17	C1525	B25	C1602	C17
C1299	J11	C1374	R02	C1450	Z18	C1526	B32	C1603	N11
C1300	M06	C1375	R02			C1527	J13	C1604	N11
C1301-C1350		C1376	H06	C1451-C1500		C1528	N17	C1605	N11
C1301	Z17	C1377	H04	C1451	C14	C1529	C15	C1606	N11
C1302	A14	C1378	J21	C1452	B25	C1530	C15	C1607	N11
C1303	A14	C1379	J12	C1453	B25	C1531	Z18	C1608	X02
C1304	C29	C1380	H04	C1454	C14	C1532	B25	C1609	C15
C1305	O03	C1381	Z17	C1455	C15	C1533	B35	C1610	C33
C1306	Z14	C1382	B24	C1456	X03	C1534	B25	C1611	B25
C1307	A14	C1383	Z17	C1457	Z18	C1535	X03	C1612	T05
C1308	T02	C1384	C19	C1458	J12	C1536	B35	C1613	Z09
C1309	A14	C1385	C19	C1459	J21	C1537	J13	C1614	N17
C1310	B35	C1386	C27	C1460	J12	C1538	O03	C1615	N11
C1311	Q02	C1387	C26	C1461	J12	C1539	J13	C1616	J13
C1312	H10	C1388	C30	C1462	C15	C1540	N11	C1617	A20
C1313	B17	C1389	C17	C1463	Z18	C1541	N11	C1618	A14
C1314	A14	C1390	C14	C1464	C33	C1542	B25	C1619	A15
C1315	N10	C1391	C14	C1465	C15	C1543	N15	C1620	Z18
C1316	B31	C1392	C26	C1466	C22	C1544	B25	C1621	T05
C1317	A14	C1393	J22	C1467	C19	C1545	X03	C1622	B25
C1318	B24	C1394	M06	C1468	X02	C1546	Z18	C1623	C30
C1319	N17	C1395	B35	C1469	X02	C1547	B32	C1624	N11
C1320	N17	C1396	M06	C1470	J12	C1548	T02	C1625	N15
C1321	J12	C1397	B35	C1471	C15	C1549	B32	C1626	N11
C1322	Z12	C1398	M04	C1472	K02	C1550	B35	C1627	N11
		C1399	B24	C1473	X03			C1628	C26
				C1474	E03	C1551-C1600		C1629	C33

C1630	Z06	C1708	Z17	C1786	C21	C1862	J15	C1940	B26
C1631	Z06	C1709	J14	C1787	N15	C1863	O03	C1941	M07
C1632	U01	C1710	Q02	C1788	K02	C1864	B18	C1942	M07
C1634	O03	C1711	B36	C1789	T05	C1865	Z08	C1943	C15
C1635	O03	C1712	Z19	C1790	B36	C1866	C15	C1944	A15
C1636	O03	C1713	B26	C1791	B18	C1867	J14	C1945	B26
C1637	N11	C1714	B32	C1792	N12	C1868	Z20	C1946	J21
C1638	O02	C1715	M06	C1793	N12	C1869	C26	C1947	N12
C1639	D02	C1716	N11	C1794	A15	C1870	C26	C1948	B18
C1640	C22	C1717	J14	C1795	J15	C1871	O03	C1949	J16
C1641	J13	C1718	B32	C1796	J15	C1872	C24	C1950	J16
C1642	C22	C1719	A15	C1797	A15	C1873	B26		
C1643	J13	C1720	B26	C1798	Z09	C1874	B26	C1951-C1999	
C1644	Z19	C1721	B26	C1799	K03	C1875	H07	C1951	B27
C1645	J13	C1722	B26	C1800	H09	C1876	B26	C1952	M07
C1646	C30	C1723	B32			C1877	J14	C1953	J16
C1647	J13	C1724	N11	C1801-C1850		C1878	Z20	C1954	B27
C1648	C29	C1725	Z19	C1801	Z13	C1879	Z09	C1955	Z04
C1649	C33	C1726	J14	C1802	H09	C1880	Q02	C1956	N12
C1650	D02	C1727	N12	C1803	Z19	C1881	O03	C1957	N12
		C1728	J22	C1804	B18	C1882	M06	C1958	Z09
		C1729	B26	C1805	B32	C1883	A15	C1959	C27
C1651-C1700			X03	C1806	B36	C1884	M07	C1960	H09
C1651	Z19	C1730	B18	C1807	I02	C1885	Z20	C1961	N12
C1652	A15	C1731	N18	C1808	J15	C1886	B26	C1962	H09
C1653	Z03	C1732	B18	C1809	Z19	C1887	B18	C1963	J16
C1654	O02	C1733	Z19	C1810	C21	C1888	B36	C1964	C33
C1655	J13	C1734	B26	C1811	J15	C1889	B36	C1965	K03
C1656	J13	C1735	B26	C1812	N18	C1890	P02	C1966	N17
C1657	Z19	C1736	B32	C1813	H10	C1891	A15	C1967	N18
C1658	N11	C1737	C19	C1814	Z01	C1892	A15	C1968	C15
C1659	A20	C1738	B32	C1815	Z02	C1893	J15	C1969	D02
C1660	B25	C1739	J14	C1816	Y02	C1894	J15	C1970	N12
C1661	J13	C1740	J14	C1817	Y02	C1895	J15	C1971	Z20
C1662	Z19	C1741	Z19	C1818	J15	C1896	J16	C1972	N16
C1663	B17	C1742	Z06	C1819	J15	C1897	M08	C1973	C29
C1664	N18	C1743	Z06	C1820	A15	C1898	C27	C1974	X02
C1665	C19	C1744	B26	C1821	J15	C1899	J16	C1975	J16
C1666	Z19	C1745	C33	C1822	B26	C1900	H10	C1976	J16
C1667	J13	C1746	X02	C1823	C33			C1977	D02
C1668	A21	C1747	B36	C1824	N09	C1901-C1950		C1978	A15
C1669	N15	C1748	J14	C1825	C24	C1901	N12	C1979	B27
C1670	H11	C1749	B25	C1826	C15	C1902	N12	C1980	J16
C1671	H11	C1750	C1827		X03	C1903	H03	C1981	B27
C1672			C1828		N12	C1904	H09	C1982	J16
C1673	V02		C1829		C15	C1905	H07	C1983	H03
C1674	Z19	C1751-C1800	H11	C1830	J15	C1906	H10	C1984	Z20
C1675	A15	C1751	H03	C1831	J15	C1907	J16	C1985	N12
C1676	Z19	C1752	Z19	C1832	N12	C1908	K04	C1986	C19
C1677	H03	C1753	C30	C1833	J15	C1909	J21	C1987	A15
C1678	D02	C1754	Z19	C1834	J15	C1910	J16	C1988	E05
C1679	B36	C1755	B25	C1835	T03	C1911	K04	C1989	H03
C1680	N11	C1756	N12	C1836	Q02	C1912	J16	C1990	H03
C1681	Z19	C1757	C24	C1837	Z01	C1913	C27	C1991	D02
C1682	N16	C1758	B25	C1838	A15	C1914	B18	C1992	Z20
C1683	B36	C1759	J22	C1839	Z19	C1915	C19	C1993	Z20
C1684	B32	C1760	J14	C1840	A15	C1916	J16	C1994	Z20
C1685	N11	C1761	J14	C1841	A14	C1917	C17	C1995	J16
C1686	J14	C1762	B26	C1842	C27	C1918	B26	C1996	B27
C1687	B17	C1763	B26	C1843	A15	C1919	J16	C1997	M07
C1688	J14	C1764	B26	C1844	J15	C1920	C15	C1998	J16
C1689	J22	C1765	J14	C1845	M06	C1921	M07	C1999	B36
C1690	C19	C1766	Z19	C1846	X02	C1922	X01		
C1691	J14	C1767	B18	C1847	H11	C1923	N12	C3000-C3050	
C1692	B25	C1768	J21	C1848	J22	C1924	H11	C3000	M09
C1693	Y01	C1769	B36	C1849	B26	C1925	Z20	C3001	X01
C1694	M09	C1770	B18	C1850	B26	C1926	N18	C3002	C22
C1695	J14	C1771	J14			C1927	T03	C3003	A15
C1696	Z19	C1772	B18	C1851-C1900		C1928	N18	C3004	A15
C1697	N11	C1773	D02	C1851	B26	C1929	T03	C3005	A16
C1698	N11	C1774	A15	C1852	B36	C1930	J16	C3006	C21
C1699	J14	C1775	C24	C1853	K03	C1931	C17	C3007	C28
C1700	J14	C1776	Q02	C1854	Z08	C1932	F03	C3008	C17
		C1777	Z13	C1855	M04	C1933	B26	C3009	J16
C1701-C1750			M06	C1856	Z07	C1934	B26	C3010	Z20
C1701	J14	C1779	Z19	C1857	Z09	C1935	J16	C3011	C22
C1702	J14	C1780	J14	C1858	J15	C1936	M07	C3012	C19
C1703	N18	C1781	C15	C1859	J15	C1937	C29	C3013	N12
C1704	B25	C1782	C19	C1860	Z01	C1938	D02	C3014	Z20
C1705	J14	C1783	C33	C1861	Z07	C1939	Z07	C3015	J17
C1706	C33	C1784							
C1707	B26	C1785							

C3016	N09	C3094	N15	C3232	I02	C3309	A17	C3388	C34
C3017	A16	C3095	B27	C3234	Z21	C3310	P02	C3389	Z22
C3018	M09	C3096	B18	C3235	I02	C3311	J18	C3390	C34
C3019	Z03			C3236	J17	C3312	B28	C3391	Y01
C3020	K04	<b>C3159-C3200</b>		C3237	Z07	C3313	J18	C3392	Z12
C3021	H08	C3159	Z20	C3238	J17	C3314	J18	C3393	Z22
C3022	O02	C3160	A16	C3239	C34	C3315	A17	C3394	Z14
C3023	Z05	C3161	Z20	C3240	C25	C3316	A17	C3395	T03
C3024	C19	C3162	D02	C3241	B28	C3317	A17	C3396	Z11
C3025	C26	C3163	Z04	C3242	M09	C3318	J18	C3397	A17
C3026	C21	C3164	T03	C3243	C25	C3319	C16	C3398	A17
C3027	Z20	C3165	A16	C3244	N/A	C3320	B28	C3399	E05
C3028	A16	C3166	X02	C3245	J22	C3321	T05	C3400	A17
C3029	T04	C3167	A16	C3246	Z21	C3322	T05		
C3030	D02	C3168	T05	C3247	Z07	C3323	T05	<b>C3401-C3450</b>	
C3031	H08	C3169	M09	C3248	B36	C3324	J18	C3401	A17
C3032	H04	C3170	B32	C3249	I02	C3325	J18	C3402	C16
C3033	J17	C3171	B27	C3250	C20	C3326	B28	C3403	Z03
C3034	X03	C3172	B27			C3327	A17	C3404	C28
C3035	C15	C3173	B36	<b>C3251-C3300</b>		C3328	B28	C3405	J18
C3036	C19	C3174	J17	C3251	I02	C3329	J18	C3406	C16
C3037	N12	C3175	A16	C3252	Z21	C3330	I02	C3407	F05
C3038	C19	C3176	B18	C3253	C21	C3331	A17	C3408	F04
C3039	N12	C3177	Z20	C3254	C26	C3332	Z21	C3409	N09
C3040	N12	C3178	M09	C3255	Z21	C3333	W01	C3410	B33
C3041	Z20	C3179	C34	C3256	C25	C3334	C21	C3411	F07
C3042	J17	C3180	C22	C3257	C22	C3335	Z09	C3412	F07
C3043	B32	C3181	Z21	C3258	C34	C3336	C26	C3413	T05
C3044	A16	C3182	B27	C3259	T17	C3337	Z21	C3414	C29
C3045	C33	C3183	C22	C3260	C29	C3338	N13	C3415	C29
C3046	A16	C3184	C21	C3261	B28	C3339	Y01	C3416	H03
C3047	C34	C3185	Z21	C3262	C20	C3340	J18	C3417	N13
C3048	C15	C3186	A16	C3263	N13	C3341	A17	C3418	A21
C3049	N12	C3187	C26	C3264	C22	C3342	B18	C3419	C27
C3050	N13	C3188	B36	C3265	J17	C3343	A17	C3420	C30
		C3189	Z21	C3266	I02	C3344	M07	C3421	A17
		C3190	J17	C3267	B37	C3345	B32	C3422	X01
<b>C3051-C3096</b>		C3191	B27	C3268	Z21	C3346	N13	C3423	C20
C3051	C15	C3191	B27	C3268	Z21	C3346	N13	C3423	C20
C3052	N13	C3192	Z21	C3269	A16	C3347	N13	C3424	A18
C3053	Q02	C3193	C25	C3270	J18	C3348	K03	C3425	Z07
C3054	C15	C3194	B28	C3271	A15	C3349	C25	C3426	Z10
C3055	B32	C3195	Z07	C3272	Z21	C3350	A21	C3427	J19
C3056	C34	C3196	N15	C3273	A16			C3428	N17
C3057	Z09	C3197	S01	C3274	C34	<b>C3351-C3400</b>		C3429	Z07
C3058	A16	C3198	S01	C3275	X01	C3351	Z21	C3430	Z10
C3059	J22	C3199	H09	C3276	C28	C3352	G04	C3431	C27
C3060	Z20	C3200	F06	C3277	B28	C3353	Z21	C3432	Z22
C3061	Y02			C3278	B37	C3354	E05	C3433	C25
C3062	VO2	<b>C3201-C3250</b>		C3279	C30	C3355	Z21	C3434	A18
C3063	J17	C3201	F06	C3280	C30	C3356	C26	C3435	C27
C3064	B36	C3202	F04	C3281	A16	C3357	H03	C3436	Z10
C3065	T05	C3203	J22	C3282	Z21	C3358	G04	C3437	C29
C3066	B27	C3204	Z04	C3283	A16	C3359	A17	C3438	Q02
C3067	C15	C3205	Z21	C3284	A16	C3360	A17	C3439	Q02
C3068	I02	C3206	B28	C3285	A16	C3361	J18	C3440	G04
C3069	H08	C3207	B36	C3286	J18	C3362	A17	C3441	N13
C3070	J17	C3208	Q02	C3287	J23	C3363	B18	C3442	C28
C3071	B27	C3209	J17	C3288	A17	C3364	A17	C3443	C20
C3072	Z20	C3210	L02	C3289	H04	C3365	O04	C3444	C27
C3073	W01	C3211	C26	C3290	Z21	C3366	B33	C3445	N13
C3074	N18	C3212	C26	C3291	J18	C3367	B18	C3446	K03
C3075	N18	C3213	Z04	C3292	X01	C3368	B18	C3447	A18
C3076	B32	C3214	Z04	C3293	H08	C3369	F05	C3448	Z07
C3077	B32	C3215	A16	C3294	J18	C3371	C26	C3449	Z07
C3078	C34	C3216	C19	C3295	C22	C3372	B28	C3450	Z07
C3079	C34	C3217	N17	C3296	M07	C3373	J18		
C3080	C34	C3218	C20	C3297	M07	C3374	C20	<b>C3451-C3500</b>	
C3081	Z08	C3219	C28	C3298	E05	C3375	C22	C3451	X04
C3082	O04	C3220	J17	C3299	Z09	C3376	J18	C3452	E05
C3083	J17	C3221	J17	C3300	C30	C3377	J18	C3453	C34
C3084	B35	C3222	J17			C3378	H11	C3454	C28
C3085	Z08	C3223	N18	<b>C3301-C3350</b>		C3379	Z21	C3455	Z01
C3086	Z20	C3224	A16	C3301	C30	C3380	C27	C3456	A18
C3087	J17	C3225	J17	C3302	A17	C3381	Z21	C3457	B33
C3088	J17	C3226	I02	C3303	J18	C3382	J18	C3458	K03
C3089	J17	C3227	B32	C3304	J18	C3383	B18	C3459	A18
C3090	M08	C3228	C30	C3305	K03	C3384	H09	C3460	I02
C3091	Z20	C3229	Z06	C3306	A17	C3385	Z12	C3461	C34
C3092	M08	C3230	M04	C3307	Y02	C3386	Z12	C3462	Z22
C3093	Z08	C3231	C20	C3308	A22	C3387	D03	C3463	K03

C3464	Z22	C3542	X03	C3618	N13	C3696	B37	C3785	C28
C3465	Z22	C3543	J19	C3619	B28	C3697	A21	C3786	Q03
C3466	C28	C3544	Z12	C3620	B28	C3698	Z23	C3787	M07
C3467	H07	C3545	Z12	C3621	C20	C3699	H04	C3788	A19
C3468	I02	C3546	Z12	C3622	Z22	C3700	J19	C3789	C35
C3469	T04	C3547	C34	C3623	Z07			C3790	B37
C3470	C29	C3548	Z04	C3624	B19	<b>C3701-C3750</b>		C3791	N18
C3471	O04	C3549	B33	C3625	O04	C3701	C20	C3792	C35
C3472	X04	C3550	O04	C3626	B28	C3702	N13	C3793	C20
C3473	K03			C3627	F07	C3703	Z10	C3794	H06
C3474	B18	<b>C3551-C3600</b>		C3628	X02	C3704	Z10	C3795	C35
C3475	A18	C3551	C34	C3629	N/A	C3705	C22	C3796	C17
C3476	C20	C3552	N13	C3630	K04	C3706	X02	C3797	C35
C3477	M07	C3553	N13	C3631	C25	C3707	Z04	C3798	H11
C3478	M04	C3554	Z22	C3632	K03	C3708	Z12	C3799	Z14
C3479	B18	C3555	J19	C3633	B37	C3709	Z12	C3800	Y01
C3480	Z22	C3556	C20	C3634	B28	C3710	N/A		
C3481	Z22	C3557	C34	C3635	Z22	C3711	A18	<b>C3801-C3850</b>	
C3482	P02	C3558	J19	C3636	B37	C3712	Z12	C3802	Z23
C3483	N13	C3559	Z09	C3637	Z22	C3713	Z13	C3803	A19
C3484	W02	C3560	C20	C3638	J19	C3714	Z13	C3804	B29
C3485	C22	C3561	J21	C3639	O04	C3715	T04	C3805	K03
C3486	Z10	C3562	I02	C3640	A21	C3716	Z23	C3806	J20
C3487	T03	C3563	A18	C3641	Z14	C3717	J19	C3807	J20
C3488	P02	C3564	H08	C3642	C16	C3718	Z06	C3808	N14
C3489	Z10	C3565	B37	C3643	B28	C3719	B37	C3809	Z23
C3490	L02	C3566	H11	C3644	Z22	C3720	C25	C3810	A19
C3491	J19	C3567	H08	C3645	Y02	C3721	C20	C3811	W02
C3492	C16	C3568	A18	C3646	Z22	C3722	A18	C3812	N/A
C3493	B33	C3569	Z09	C3647	J23	C3723	M07	C3813	Z23
C3494	J19	C3570	B28	C3648	N13	C3737	C35	C3814	H11
C3495	T03	C3571	J21	C3649	Z14	C3738	C35	C3815	J20
C3496	C21	C3572	H08	C3650	N13	C3739	B28	C3816	C28
C3497	N13	C3573	Z22			C3740	Z21	C3817	H05
C3498	Z22	C3574	C16	<b>C3651-C3700</b>		C3741	B29	C3818	G05
C3499	C34	C3575	Z09	C3651	B33	C3742	T05	C3819	C16
C3500	H07	C3576	Z09	C3652	Z03	C3743	C16	C3820	S01
		C3577	A21	C3653	N13	C3744	C21	C3821	G05
		C3578	G04	C3654	A18	C3745	X02	C3822	J20
<b>C3501-C3550</b>		C3579	Z14	C3655	B28	C3746	N/A	C3823	I03
C3501	G04	C3579	Z14	C3655	B28	C3746	N/A	C3823	I03
C3502	X03	C3580	G04	C3656	J19	C3747	G05	C3824	J21
C3503	N09	C3581	B37	C3657	V02	C3748	Z23	C3825	B29
C3504	B33	C3582	A21	C3658	B37	C3749	C25	C3826	N/A
C3505	C28	C3583	B19	C3659	N17	C3750	H11	C3827	Y03
C3506	A18	C3584	N09	C3660	O04			C3828	Z23
C3507	J19	C3585	B28	C3661	M07	<b>C3751-C3800</b>		C3829	K04
C3508	C20	C3586	I02	C3662	N13	C3751	A21	C3830	T05
C3509	M07	C3587	G05	C3663	Z04	C3752	N/A	C3831	K04
C3510	A21	C3588	Z07	C3664	B28	C3753	C20	C3832	Z14
C3511	C34	C3589	Q02	C3665	O04	C3754	C35	C3833	Z23
C3512	Z03	C3590	J21	C3666	A18	C3755	Y01	C3834	N14
C3513	J19	C3591	B19	C3667	C34	C3756	N/A	C3835	B37
C3514	H04	C3592	Z22	C3668	X03	C3757	B37	C3836	J20
C3515	H04	C3593	I03	C3669	N/A	C3758	Z07	C3837	N14
C3516	H07	C3594	T03	C3670	N/A	C3759	N14	C3838	J20
C3517	C16	C3595	I03	C3671	Z23	C3760	B36	C3839	B19
C3518	H06	C3596	T03	C3672	O04	C3761	N14	C3840	N/A
C3519	C25	C3597	I03	C3673	Z23	C3762	Y02	C3841	W02
C3520	H11	C3598	K04	C3674	K03	C3763	N16	C3842	C16
C3521	Q02	C3599	C25	C3675	J23	C3764	S01	C3843	W02
C3522	H04	C3600	I03	C3676	Z23	C3765	C28	C3844	A19
C3523	Z22			C3677	J19	C3766	Z07	C3845	Z12
C3524	J19	<b>C3601-C3650</b>		C3678	C27	C3767	S01	C3846	V02
C3525	N18	C3601	I03	C3679	C16	C3768	N14	C3847	X01
C3526	N13	C3602	I03	C3680	Z04	C3769	C17	C3848	C35
C3527	J19	C3603	Z22	C3681	N18	C3770	F04	C3849	V02
C3528	K04	C3604	H11	C3682	C34	C3771	B36	C3850	A19
C3529	C25	C3605	Z22	C3683	Z08	C3772	N18		
C3530	C16	C3606	T05	C3684	Z23	C3773	N18	<b>C3851-C3900</b>	
C3531	C23	C3607	Z02	C3685	Z23	C3774	Z23	C3851	N14
C3532	A18	C3608	N/A	C3686	X02	C3775	J19	C3852	Z23
C3533	A18	C3609	A18	C3687	Y03	C3776	C29	C3853	B29
C3534	A18	C3610	B37	C3688	B37	C3777	Z23	C3854	Q03
C3535	J19	C3611	C25	C3689	C28	C3778	J19	C3855	N/A
C3536	A18	C3612	Z13	C3690	W02	C3779	Z12	C3856	N/A
C3537	J19	C3613	N17	C3691	Z23	C3780	C30	C3857	Y01
C3538	H06	C3614	L02	C3692	H05	C3781	Z13	C3858	Y01
C3539	B19	C3615	L02	C3693	J19	C3782	B29	C3859	Y01
C3540	Z14	C3616	N18	C3694	F04	C3783	A18	C3860	Z23
C3541	Z09	C3617	A18	C3695	N/A	C3784	J20		

C3861	Z14	C3939	H08	C4014	X03
C3862	Z14	C3940	N/A	C4015	N/A
C3863	Z13	C3941	N/A	C4016	N/A
C3864	B19	C3942	Z07	C4017	N/A
C3865	J20	C3943	M07	C4018	N/A
C3866	C25	C3944	Z24	C4019	N/A
C3867	N/A	C3945	Y03	C4020	N/A
C3868	C35	C3946	Y03	C4021	N/A
C3869	C16	C3947	Z12	C4022	N/A
C3870	N/A	C3948	Z12	C4023	N/A
C3871	Z02	C3949	M08	C4024	N/A
C3872	M04	C3950	C23	C4025	N/A
C3873	X04			C4026	N/A
C3874	C31	C3951-C4000		C4027	N/A
C3875	C35	C3951	C20	C4028	N/A
C3876	N/A	C3952	C29	C4029	N/A
C3877	B29	C3953	C35	C4030	N/A
C3878	A19	C3954	C31	C4031	Z24
C3879	Q03	C3955	N/A	C4032	C20
C3880	C35	C3956	H07	C4033	N/A
C3881	Z22	C3957	N/A	C4034	Z04
C3882	N/A	C3958	Z24	C4035	C28
C3883	J23	C3959	N/A	C4036	A19
C3884	Q03	C3960	N/A	C4037	A19
C3885	N/A	C3961	N/A	C4038	N/A
C3886	J20	C3962	N/A	C4039	N/A
C3887	N/A	C3963	N/A	C4040	N/A
C3888	C16	C3964	N/A	C4041	N/A
C3889	N/A	C3965	N/A	C4042	N/A
C3890	X04	C3966	N/A	C4043	N/A
C3891	J20	C3967	B29	C4044	N/A
C3892	M07	C3968	N/A	C4045	N/A
C3893	C21	C3969	J21	C4046	N/A
C3894	C25	C3970	N/A	C4047	N/A
C3895	N16	C3971	J20	C4048	N/A
C3896	J20	C3972	Q04	C4049	N/A
C3897	N/A	C3973	B37	C4050	N/A
C3898	J20	C3974	N/A		
C3899	C17	C3975	N/A	C4051-C4100	
C3900	Z23	C3976	N/A	C4051	N/A
		C3977	N/A	C4052	N/A
		C3978	N/A	C4053	N/A
		C3979	N/A	C4054	N/A
		C3980	N/A	C4055	N/A
		C3981	N/A	C4056	N/A
		C3982	N/A	C4057	N/A
		C3983	J20	C4058	N/A
		C3984	Z24	C4059	N/A
		C3985	N/A	C4060	N/A
		C3986	N/A	C4061	N/A
		C3987	N/A	C4062	N/A
		C3988	H11	C4063	N/A
		C3989	N/A	C4064	N/A
		C3990	N14	C4065	N/A
		C3991	G05	C4066	N/A
		C3992	G05	C4067	N/A
		C3993	Z03	C4068	N/A
		C3994	G05	C4069	N/A
		C3995	G05	C4070	N/A
		C3996	C30	C4071	N/A
		C3997	N/A	C4072	N/A
		C3998	N/A	C4073	N/A
		C3999	N/A	C4074	A19
		C4000	N/A	C4075	N/A
				C4076	N/A
				C3924	N/A
		C4001-C4050			
		C4001	J20	C4077	N/A
		C4002	N/A	C4078	N/A
		C4003	N/A	C4079	N/A
		C4004	N/A	C4080	N/A
		C4005	N/A	C4081	N/A
		C4006	N/A	C4082	N/A
		C4007	N/A	C4082	N/A
		C4008	N/A	C4084	N/A
		C4009	N/A	C4085	N/A
		C4010	Q03	C4086	N/A
		C4011	N14	C4087	N/A
		C4012	Y01	C4088	N/A
		C4013	N/A	C4089	N/A
		C4013	N/A	C4090	N/A



<b>H1116-H2050</b>		H2072	XA14	H2150	XB03	H2226	XA12	H2302	XF04
H1116	XC02	H2073	XA14			H2227	XA12	H2304	XA17
H1117	XC02	H2074	XA15	<b>H2151-H2200</b>		H2228	XA12	H2305	XE05
H1118	XF04	H2075	XA15	H2151	XF04	H2229	XA13	H2306	XD02
H1146	XE03	H2076	XA15	H2152	XA12	H2230	XA17	H2307	XF05
H1221	XD02	H2077	XA11	H2153	XD02	H2231	XA13	H2308	XD02
H1222	XD02	H2078	XA18	H2154	XF05	H2232	XA13	H2309	XF04
H2000	XE03	H2079	XE04	H2155	XE04	H2233	XA18	H2310	XA13
H2001	XF04	H2080	XC02	H2156	XE04	H2234	XA05	H2311	XA09
H2002	XF03	H2081	XA11	H2157	XE04	H2235	XA17	H2312	XF03
H2003	XF02	H2082	XA15	H2158	XE04	H2236	XA13	H2313	XA09
H2004	XE03	H2083	XA15	H2159	XE04	H2237	XA17	H2314	XF05
H2005	XA14	H2084	XA15	H2160	XE04	H2238	XA17	H2315	XF05
H2006	XE03	H2085	XA15	H2161	XF01	H2239	N/A	H2316	XA13
H2007	XA10	H2086	XA15	H2162	XF01	H2240	XA17	H2317	XA17
H2008	XA10	H2087	XA15	H2163	XC02	H2241	XE05	H2318	XA13
H2009	XA10	H2088	XC02	H2164	XC02	H2242	XE05	H2319	XE05
H2010	XB02	H2089	XF04	H2165	XC02	H2243	XB03	H2320	XE05
H2011	XB02	H2090	XF04	H2166	XD02	H2244	XE05	H2321	XA09
H2012	XB02	H2091	XF04	H2167	XA12	H2245	XE05	H2322	XF05
H2013	XB02	H2092	XA18	H2168	XA12	H2246	XF03	H2323	XE05
H2014	XA10	H2093	XA11	H2169	XD02	H2247	XF03	H2324	XB04
H2015	XB02	H2094	XA07	H2170	XC02	H2248	XE05	H2325	XA09
H2016	XB02	H2095	XA07	H2171	XE04	H2249	XE05	H2326	XA09
H2017	XB02	H2096	XA07	H2172	XC02	H2250	XA08	H2327	XA13
H2018	XB02	H2097	XE04	H2173	XA16			H2328	XA09
H2019	XA10	H2098	XF02	H2174	XA16	<b>H2251-H2300</b>		H2329	XA17
H2020	XA10	H2099	XE04	H2175	XA12	H2251	XA18	H2330	XA09
H2021	XA10	H2100	XE04	H2176	XF03	H2252	XA08	H2331	XA17
H2022	XB02			H2177	XA12	H2253	XA17	H2332	XA17
H2023	XE03	<b>H2101-H2150</b>		H2178	XA12	H2254	XA08	H2333	XA17
H2024	XD02	H2101	XE04	H2179	XF02	H2255	XE05	H2334	XA09
H2025	XE03	H2102	XE04	H2180	XA12	H2256	XA08	H2335	XA09
H2026	XF03	H2103	XA15	H2181	XA12	H2257	XA08	H2336	XA13
H2027	XF03	H2104	XA15	H2182	XA08	H2258	XA13	H2337	XB04
H2028	XD02	H2105	XA15	H2183	XB03	H2259	XA08	H2338	XA13
H2029	XB02	H2106	XA15	H2184	XE05	H2260	XA18	H2339	XA13
H2030	XB02	H2107	XA15	H2185	XF03	H2261	XA13	H2340	XA13
H2031	XA10	H2108	XA15	H2186	XD02	H2262	XA08	H2341	XE05
H2032	XB02	H2109	XA11	H2187	XA16	H2263	XA08	H2342	XF04
H2033	XA11	H2110	XA11	H2188	XE05	H2264	XA08	H2343	XB04
H2034	XA14	H2111	XA15	H2189	XA08	H2265	XA08	H2344	XE06
H2035	XF02	H2112	XA15	H2190	XA12	H2266	XA08	H2345	XA13
H2036	XF02	H2113	XA15	H2191	XF03	H2267	XA08	H2346	XA13
H2037	XA14	H2114	XF01	H2192	XA12	H2268	XA08	H2347	XA13
H2038	XA14	H2115	XF01	H2193	XA12	H2269	XA08	H2348	XA09
H2039	XA11	H2116	XA15	H2194	XC02	H2270	XA08	H2349	XA09
H2040	XA14	H2117	XA08	H2195	XA12	H2271	XA08	H2350	XB05
H2041	XA11	H2118	XB03	H2196	XE05	H2272	XA09		
H2042	XE03	H2119	XB03	H2197	XC02	H2273	XA09	<b>H2351-H2400</b>	
H2043	XE03	H2120	XB03	H2198	XE05	H2274	XA09	H2351	XC02
H2044	XE03	H2121	XE04	H2199	XF05	H2275	XA18	H2352	XA13
H2045	XE03	H2122	XE04	H2200	XF03	H2276	XA09	H2353	XA17
H2046	XE03	H2123	XA15			H2277	XB03	H2354	XE06
H2047	XE03	H2124	XA16	<b>H2201-H2250</b>		H2278	XB03	H2355	XA13
H2048	XE03	H2125	XC02	H2201	XD02	H2279	XB03	H2356	XD02
H2049	XE03	H2126	XA08	H2202	XD02	H2280	XB03	H2357	XE06
H2050	XE03	H2127	XE04	H2203	XE05	H2281	XB03	H2358	XA17
		H2128	XE04	H2204	XE05	H2282	XB03	H2359	XC02
		H2129	XE04	H2205	XA16	H2283	XB04	H2360	N/A
<b>H2051-H2100</b>		H2130	XA12	H2206	XA16	H2284	XB04	H2361	XE06
H2051	XE03	H2131	XA12	H2207	XA16	H2285	XE05	H2362	XA17
H2053	XA11	H2132	XA16	H2208	XA16	H2286	XF03	H2363	XA09
H2054	XA11	H2133	XA12	H2209	XA16	H2287	XA09	H2364	N/A
H2055	XA11	H2134	XA16	H2210	XA16	H2288	XA09	H2365	N/A
H2056	XA11	H2135	XA12	H2211	XA16	H2289	XA09	H2366	XA17
H2057	XA11	H2136	XA12	H2212	XA16	H2290	XA09	H2367	N/A
H2058	XA14	H2137	XC02	H2213	XA16	H2291	XB04	H2368	XA13
H2059	XA14	H2138	XF01	H2214	XA16	H2292	XB04	H2369	XA14
H2060	XA14	H2139	XC02	H2215	XA16	H2293	XC02	H2370	XA14
H2061	XA11	H2140	XF04	H2216	XA17	H2294	XB04	H2371	XA14
H2062	XA14	H2141	XA16	H2217	XA17	H2295	XF03	H2372	XA10
H2063	XA11	H2142	XA16	H2218	XA17	H2296	XD02	H2373	XA10
H2064	XA11	H2143	XA16	H2219	XF05	H2297	XF05	H2374	N/A
H2065	XA11	H2144	XF02	H2220	XD02	H2298	XF02	H2375	N/A
H2066	XA11	H2145	XF02	H2221	XD02	H2299	XC02	H2376	N/A
H2067	XF01	H2146	XE04	H2222	XF03	H2300	XE05	H2377	XF04
H2068	XA11	H2147	XE04	H2223	XD02			H2378	XA17
H2069	XA07	H2148	XF04	H2224	XF02	<b>H2301-H2350</b>		H2379	XA17
H2070	XA14	H2149	XF02	H2225	XD02	H2301	XF04	H2380	N/A

H2381	.....	XA10
H2382	.....	XF03
H2383	.....	XA14
H2384	.....	XC02
H2385	.....	XE06
H2386	.....	N/A
H2387	.....	N/A
H2388	.....	N/A
H2389	.....	N/A
H2390	.....	XE06
H2391	.....	XE06
H2392	.....	XE06
H2393	.....	XE06
H2394	.....	XA17
H2395	.....	N/A
H2396	.....	XE06
H2397	.....	XA10
H2398	.....	XA10
H2399	.....	XA10
H2400	.....	N/A

**H2401-H2450**

H2401	.....	N/A
H2402	.....	N/A
H2403	.....	N/A
H2404	.....	N/A
H2405	.....	N/A
H2406	.....	N/A
H2407	.....	N/A
H2408	.....	N/A
H2409	.....	N/A
H2410	.....	N/A
H2411	.....	N/A
H2412	.....	N/A
H2413	.....	N/A
H2414	.....	N/A
H2415	.....	N/A
H2416	.....	N/A
H2417	.....	N/A
H2418	.....	N/A
H2419	.....	N/A
H2420	.....	N/A
H2421	.....	N/A
H2422	.....	N/A
H2423	.....	N/A
H2424	.....	N/A
H2425	.....	N/A
H2426	.....	N/A
H2427	.....	N/A
H2428	.....	N/A
H2429	.....	N/A
H2430	.....	N/A
H2431	.....	N/A
H2432	.....	N/A
H2433	.....	N/A
H2434	.....	N/A
H2435	.....	N/A
H2436	.....	N/A
H2437	.....	N/A
H2438	.....	N/A
H2439	.....	N/A
H2440	.....	N/A
H2441	.....	N/A
H2442	.....	N/A
H2443	.....	N/A
H2444	.....	N/A
H2445	.....	N/A
H2446	.....	N/A
H2447	.....	N/A
H2448	.....	N/A
H2449	.....	N/A
H2450	.....	N/A

**H2451-H2500**

H2451	.....	N/A
H2452	.....	N/A
H2453	.....	N/A
H2454	.....	N/A
H2455	.....	N/A
H2456	.....	N/A

— For TESLA MODEL Y 2020~PRESENT

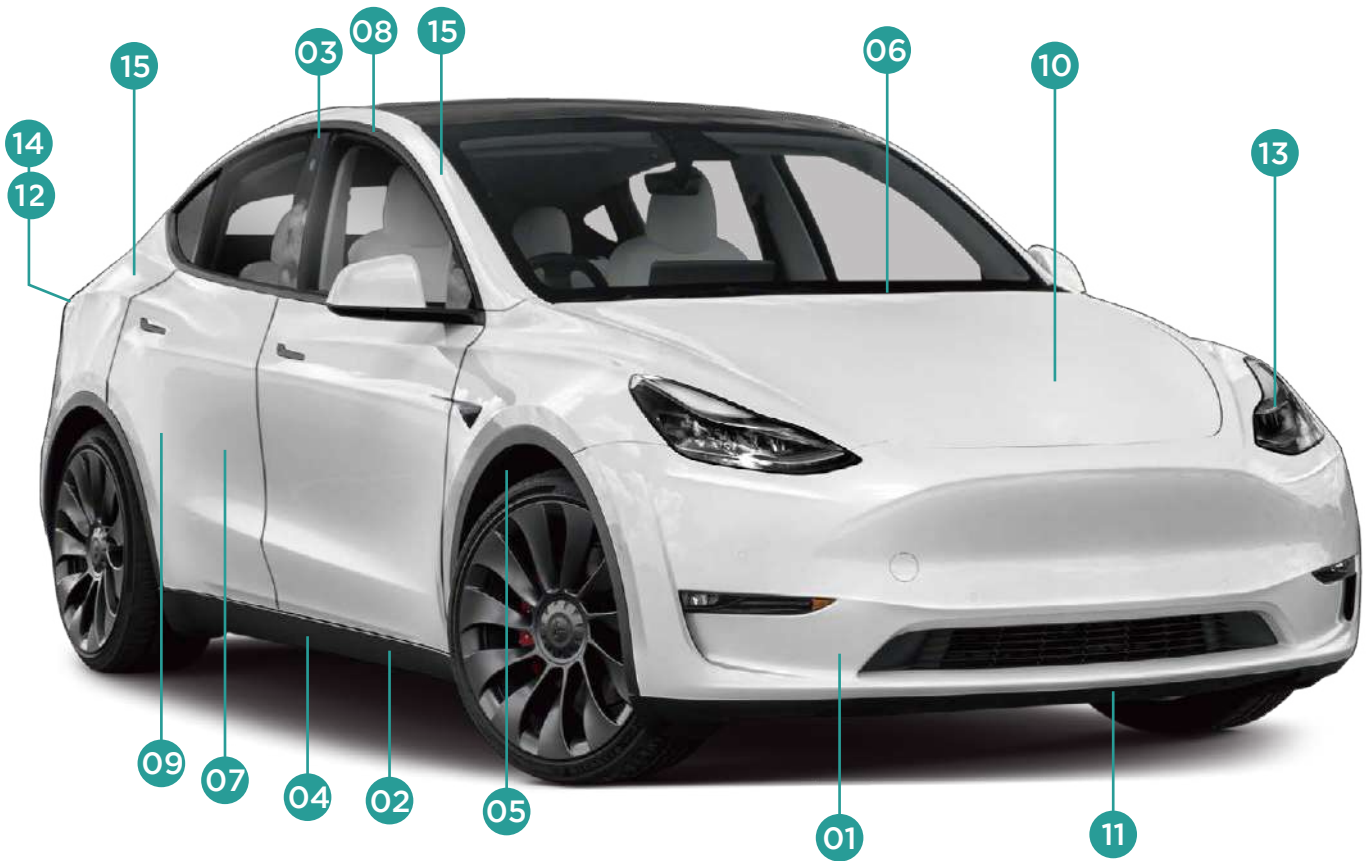

SEDAN

					
C0351 Bumper, undertray	C0649 Rocker panel	C1821 Headliner, pillar	C3361 Rocker panel	C3645 Fender liner, absorber	C3646 Cowl
					
C3647 Door panel	C3819 Side upper trim	C3823 Body cover	C3828 Front frunk luggage	C3839 Front lower fascia	C3952 Taillight
			● ● ●		
C3953 Headlamp	C3954 Taillight	C4010 Pillar, trunk trim			

— For TOYOTA COROLLA 2019~PRESENT

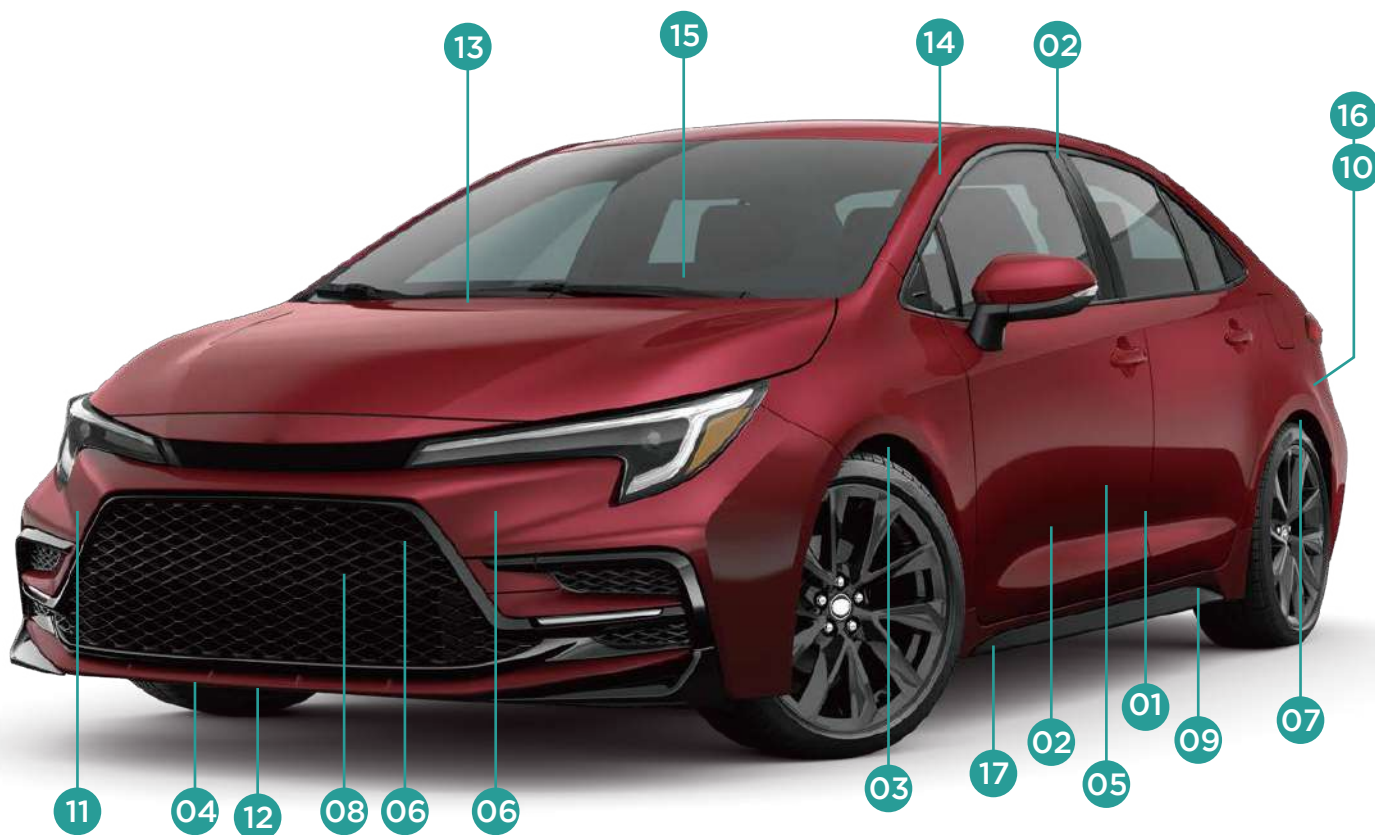

**SEDAN**

 01 C0247 Weatherstrip	 02 C0256 Door seal, pillar	 03 C0481 Fender liner, guard	 04 C0611 Front undershield	 05 C1323 Door panel	 06 C1340 Front bumper, grille
 07 C1359 Fender liner, guard	 08 C1418 Grille	 09 C1599 Light blue Rocker panel	 10 C3094 Rear bumper	 11 C3095 Bumper	 12 C3610 Undershield, fender liner
 13 C3688 Cowl	 14 C3691 Windshield	 15 C3884 Dashboard	 16 C3901 Rear bumper	 17 C3934 Rocker panel	...



— For BYD ATTO 3/ YUAN PLUS 2022~PRESENT

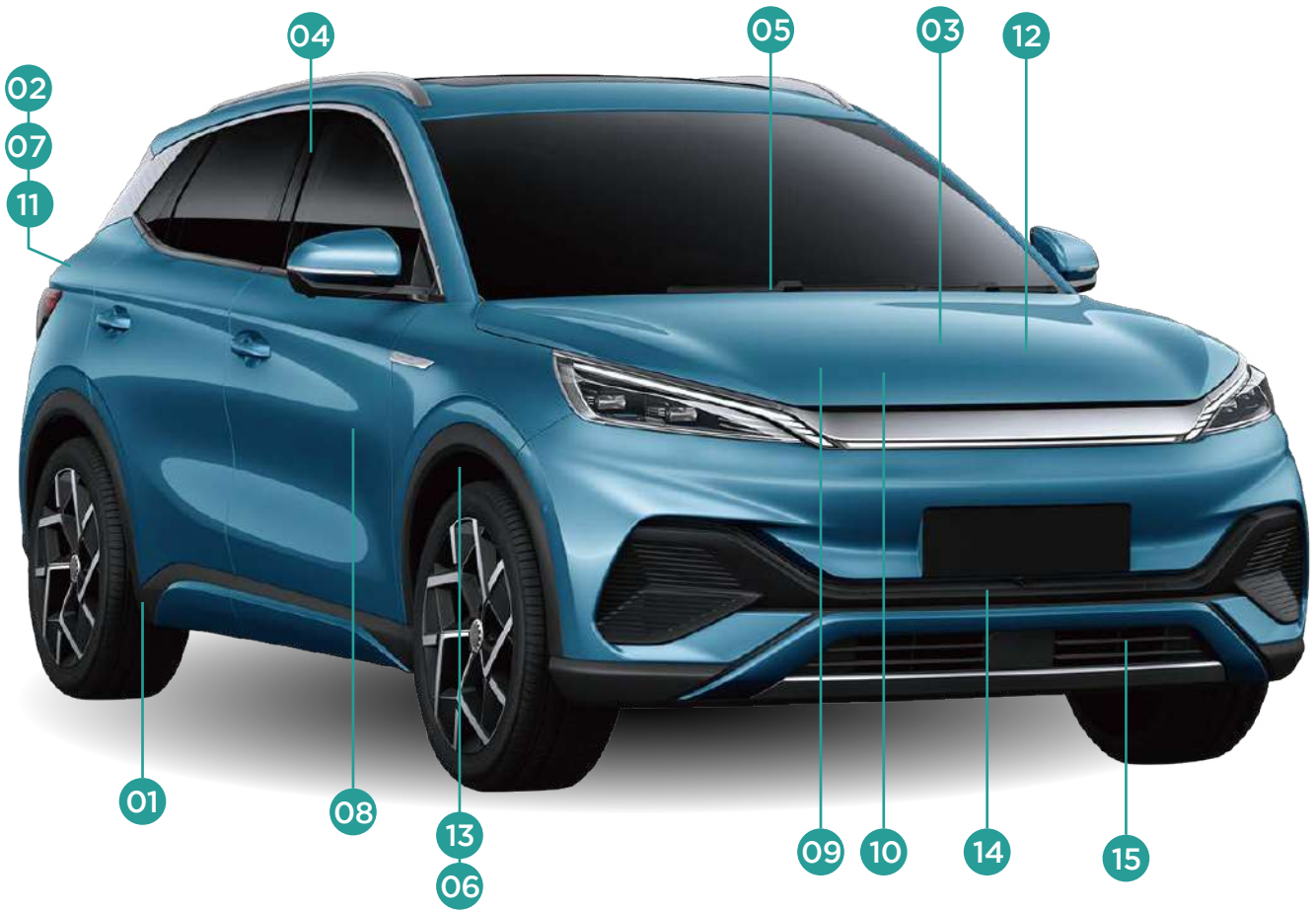

SUV

					
C0099 Splash guard	C0126 Rear liftgate	C0539 Air duct	C0564 Side molding, pillar	C0633 Cowl cover	C0634 Fender liner
					
C0900 Rear liftgate	C1041 Body plug	C1357 Front heatshield	C1587 Engine	C1821 Rear bumper	C3175 Hood insulation
			● ● ●		
C3320 Fender liner	C3651 Grille cover	H2185 Front&rear bumper			



## — For FORD F-150 (2020~PRESENT)

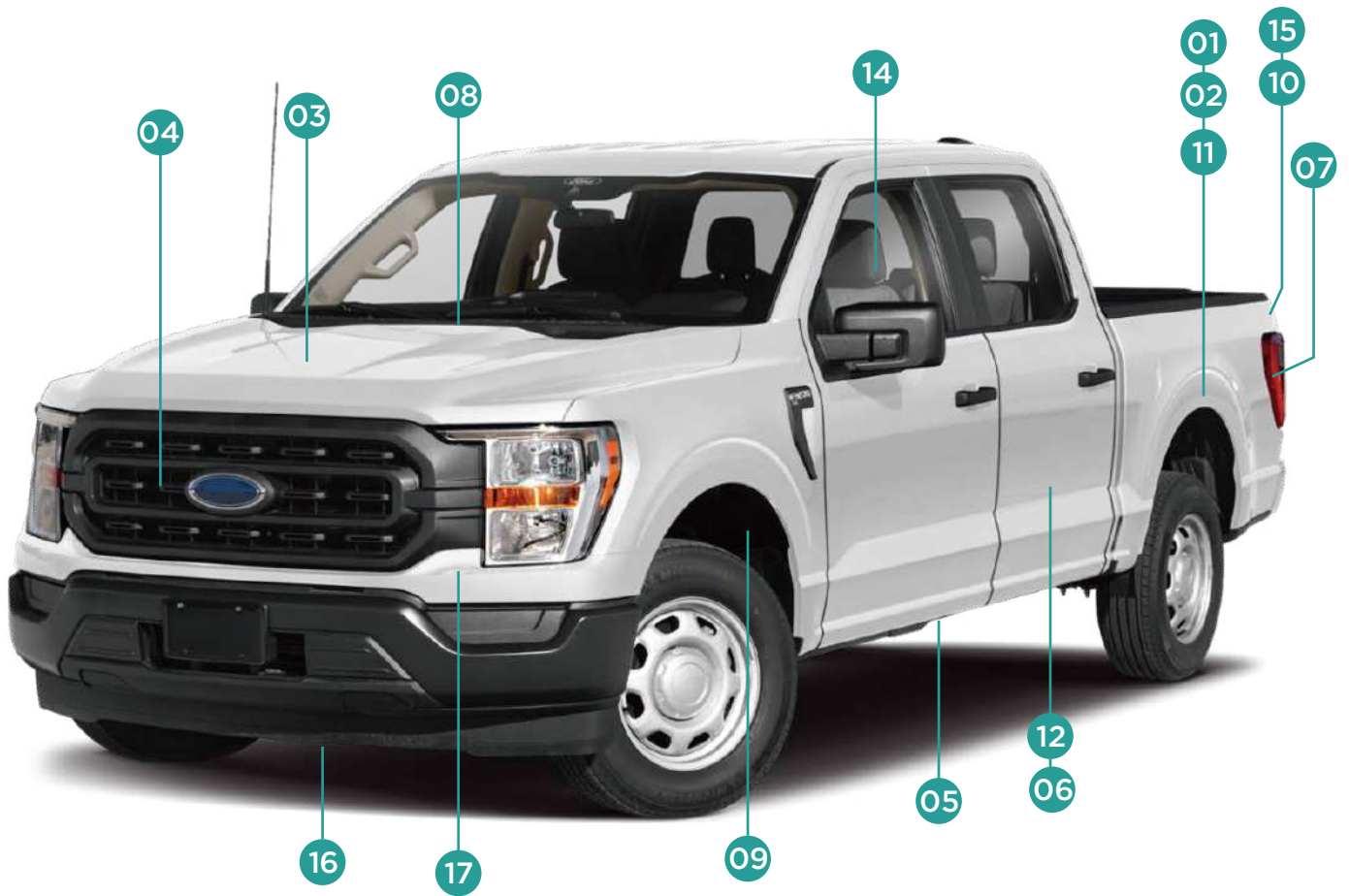

## PICK-UP



01

C3763  
Fender flare



02

C3761  
Fender flare



03

C3722  
Hood insulation



04

C3591  
Front grille



05

C3583  
Running board step pad



06

C3439  
Door panel



07

C3284  
Tail light



08

C3272  
Cowl



09

C1805  
Fender liner



10

C1770  
Rear bumper



11

C1769  
Fender flare



12

C0823  
Door panel



13

C0672  
Cowl



14

C0659  
Seat



15

C0508  
Fasten sensor



16

C0004  
Under shield



17

H2240  
Front bumper



— For HONDA CR-V (2023~PRESENT)

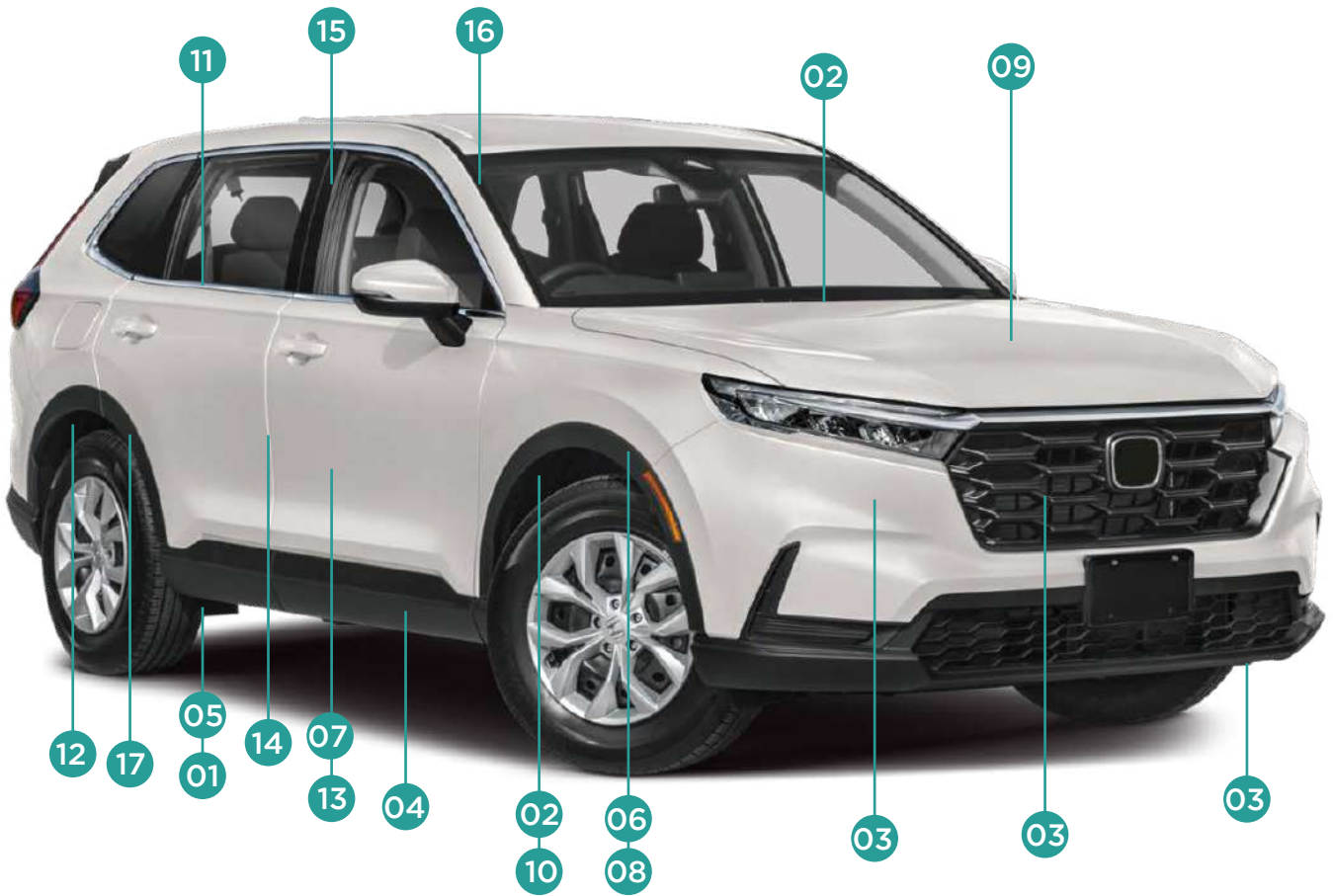

SUV

 01	 02	 03	 04	 05	 06
 07	 08	 09	 10	 11	 12
 13	 14	 15	 16	 17	

— For HYUNDAI TUCSON (2023~PRESENT)

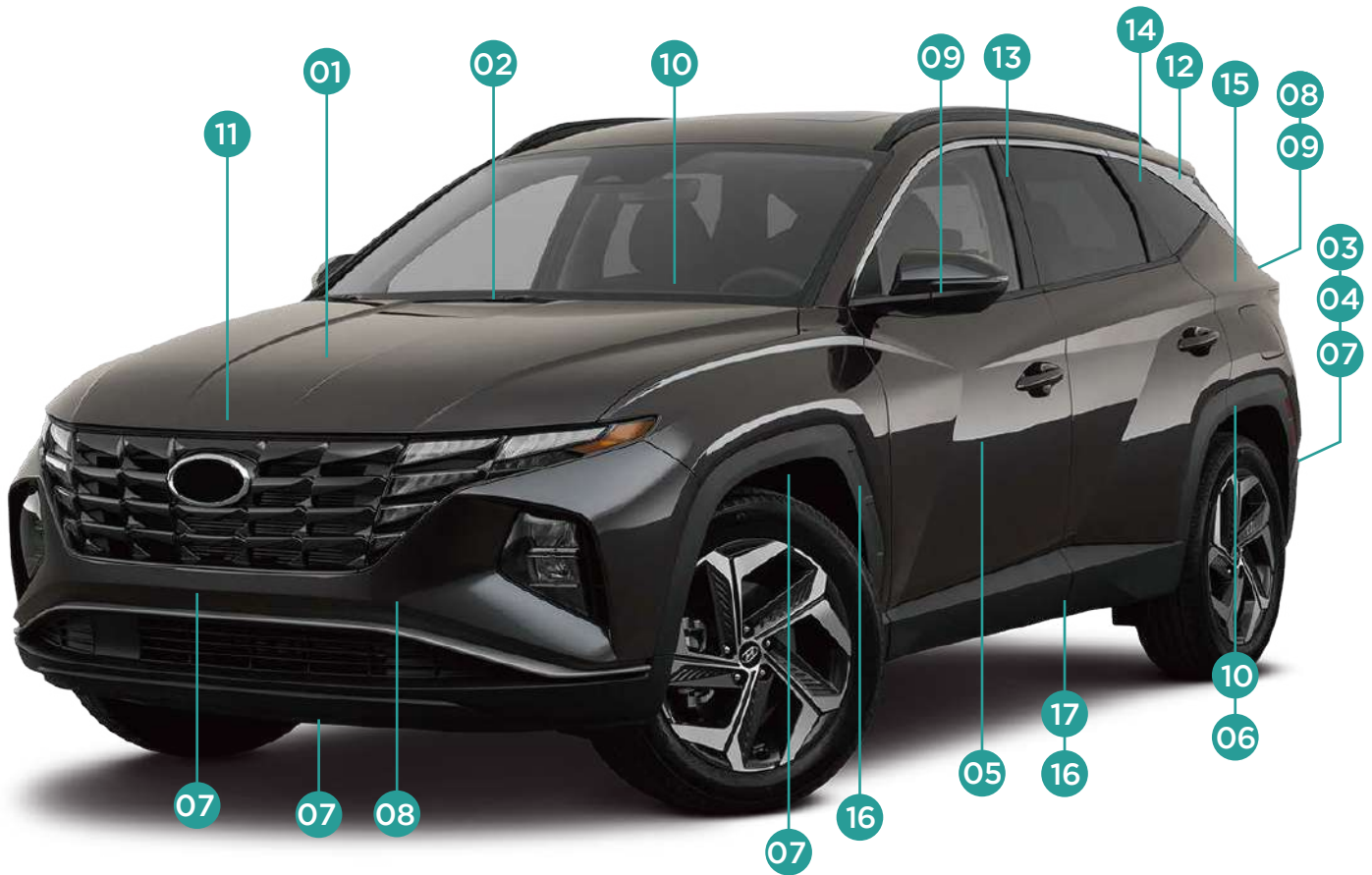

SUV

					
C0352 Hood insulation	C0578 Cowl	C0702 Rear bumper cover	C0971 Rear bumper cover	C1109 light blue Door panel	C1698 Fender flare
					
C1729 Bumper,undershield	C1783 Rear liftgate, bumper	C1796 Rear liftgate	C1880 Dashboard, flare	C1989 Hood larch release	C3037 C pillar
					...
C3042 Pillar, rear tray	C3053 Pillar	C3058 Rear side fender	C3768 Rocer panel,flare	C3990 Rocker panel	...

— For CHEVROLET SILVERADO 3500 (2019~PRESENT)

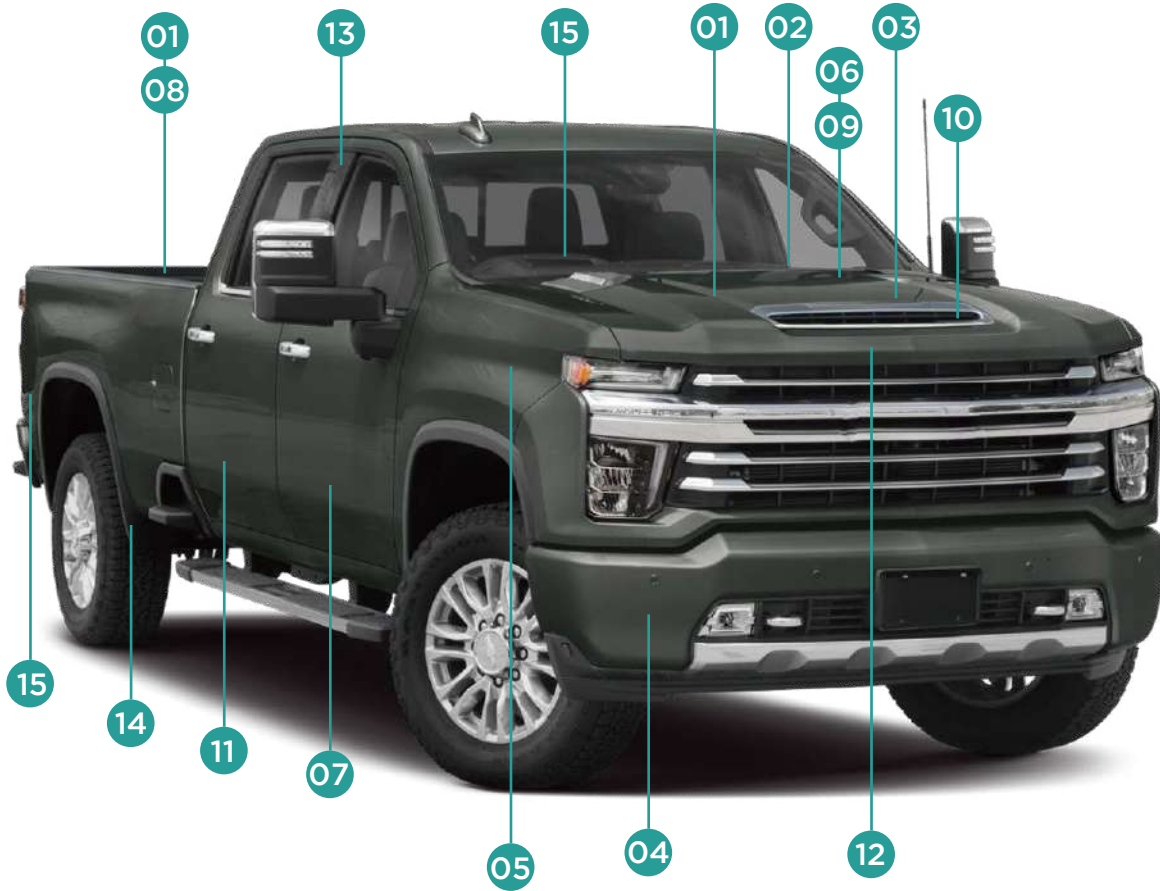

PICK-UP

					
C0582 Box panel trim	C1511 Cowl	C1769 Radiator splash shield	C1787 Front bumper	C1792 Fender	C3175 Hood insulation
					
C1858 Door panel	C3344 Box panel trim	C3363 Hood insulation	C3368 Engine cooling fan	C3405 Door panel	C3429 Hood seal
			● ● ●		
C3767 Pillar	H2255 Splash guard	H2354 Bumper, dashboard			



## For GREAT WALL HAVAL JOLION (2021~PRESENT)

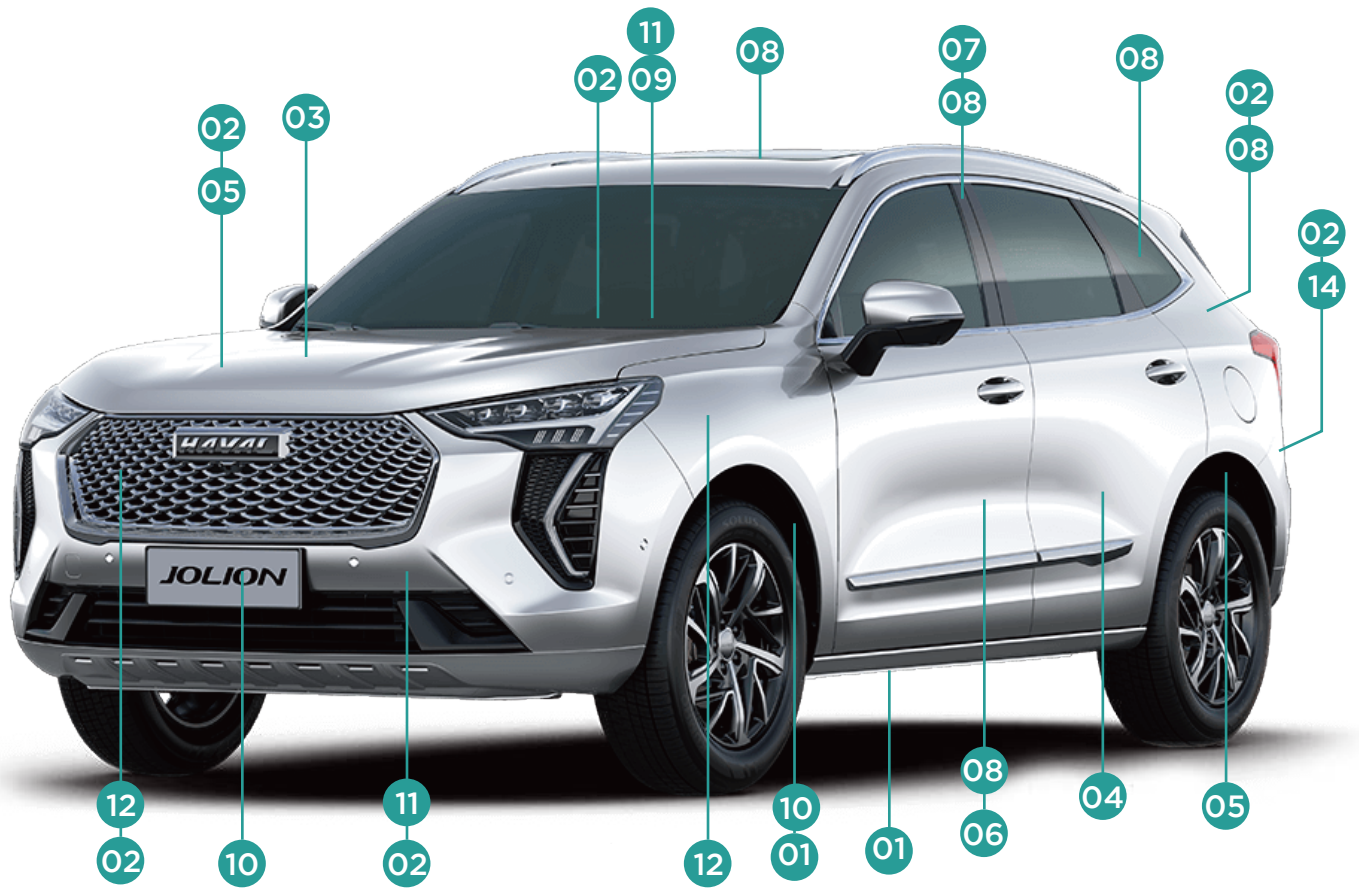

## SEDAN





— For CHEVROLET EQUINOX 2021-2022

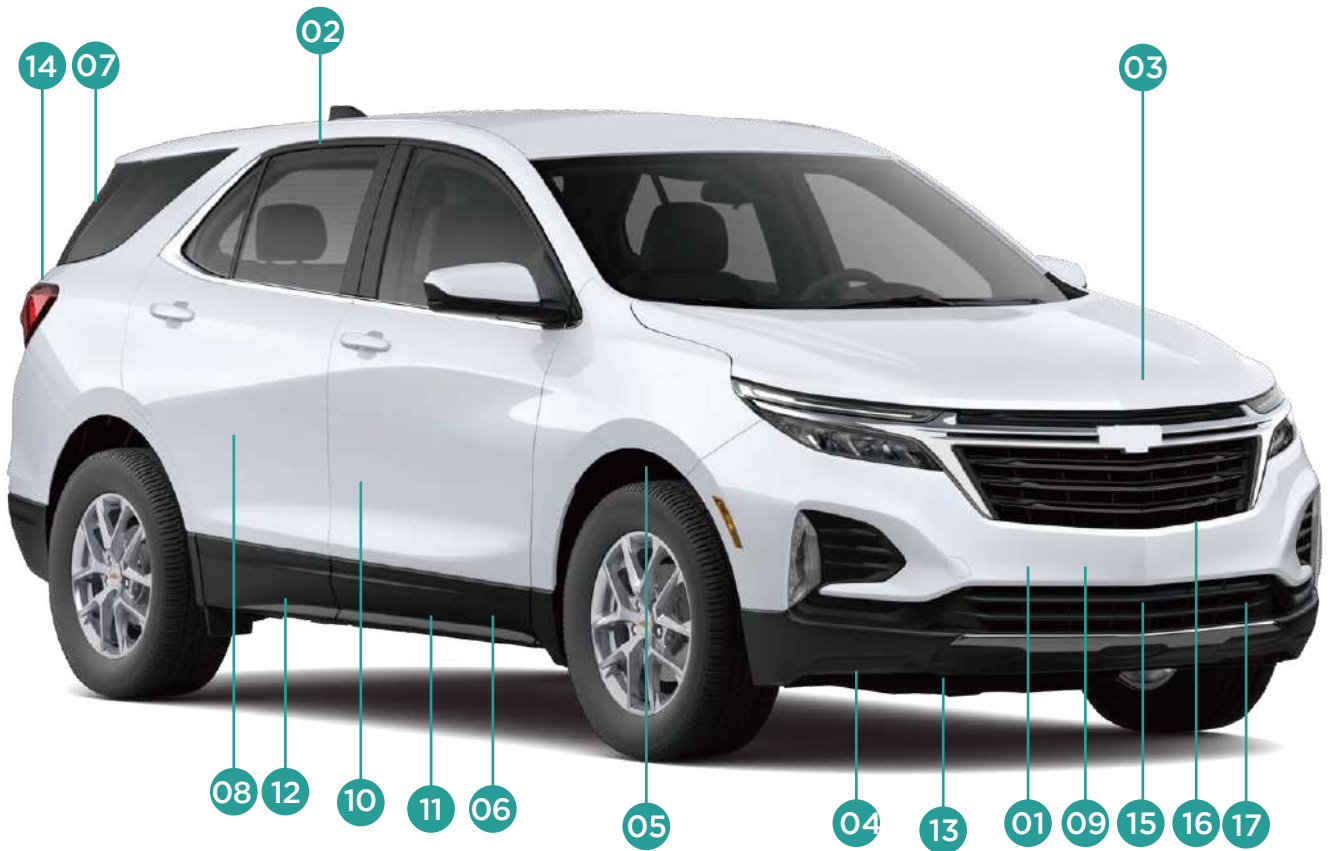

SUV

 <b>01</b>	 <b>02</b>	 <b>03</b>	 <b>04</b>	 <b>05</b>	 <b>06</b>
C0004 Front bumper	C0155 Window upper trim	C0582 Engine intake manifold	C1510 Lower guard plate	C1511 Fender liner	C1606 Rocker panel
 <b>07</b>	 <b>08</b>	 <b>09</b>	 <b>10</b>	 <b>11</b>	 <b>12</b>
C1627 Rear liftgate	C1767 Door panel	C1787 Front bumper	C1919 Door panel	C3346 Rocker panel	C3347 Rocker panel
 <b>13</b>	 <b>14</b>	 <b>15</b>	 <b>16</b>	 <b>17</b>	
C3349 Under shield	C3444 Rear liftgate	H2185 Front bumper	H2307 Front bumper	H2381 Front bumper	

## For JEEP GRAND CHEROKEE 2022



### SUV



— For BMW X5 G18 2019~PRESENT

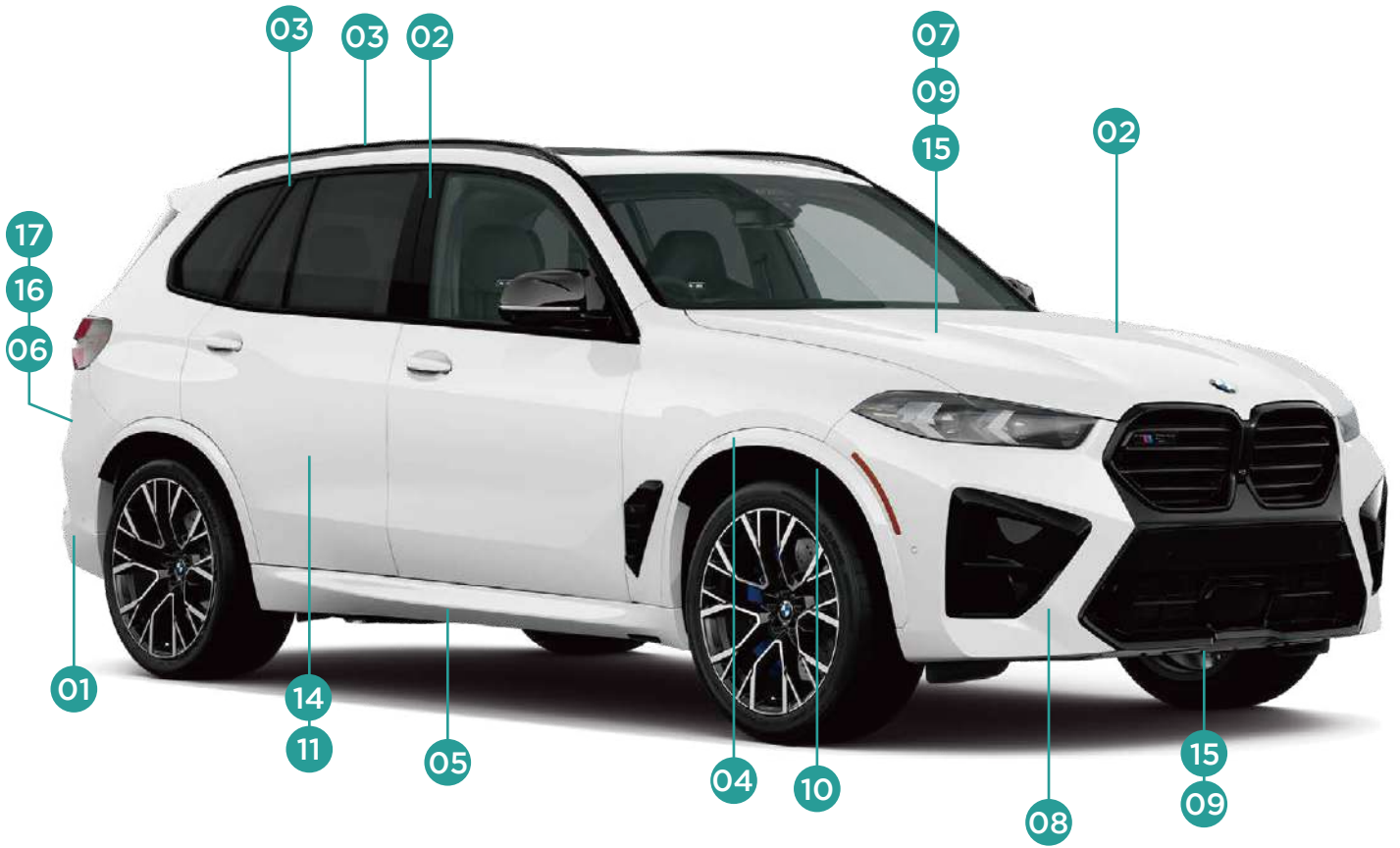

SUV

 01	 02	 03	 04	 05	 06
C0201 Rear bumper	C1253 Pillar, oil pump	C1537 no seal Pillar, headliner	C1539 Fender flare	C1591 Rocker panel	C1640 License plate
 07	 08	 09	 10	 11	 12
C3007 Sound insulator	C3056 Front bumper	C3239 Insulator, undershield	C3240 Fender liner	C3245 Door panel	C3253 Liftgate trim panel
 13	 14	 15	 16	 17	
C3255 Cable holder	C3268 Door panel	C3277 Insulator, undershield	C3294 Liftgate trim panel	C3875 Lower quarter trim	

## For MERCEDES-BENZ GLC 300



## SEDAN





— For NISSAN ROUGUE 2021~PRESENT



SUV

					
C0088 Fender	C0089 Engine lower guard	C0351 Side molding	C0817 Air duct	C1692 Grille	C1705 Luggage panel trim
					
C1706 Fender liner	C3222 Liftgate panel trim	C3224 Cowl	C3228 Pinch sensor	C3270 Luggage panel trim	C3484 Seat
					
H2088 Oil drain plug	H2340 Front bumper	H2168 Rear bumper	C3081 Windshield pillar trim	C3719 Parcel shelf sport	



## — For MAZDA CX-5 2021~PRESENT

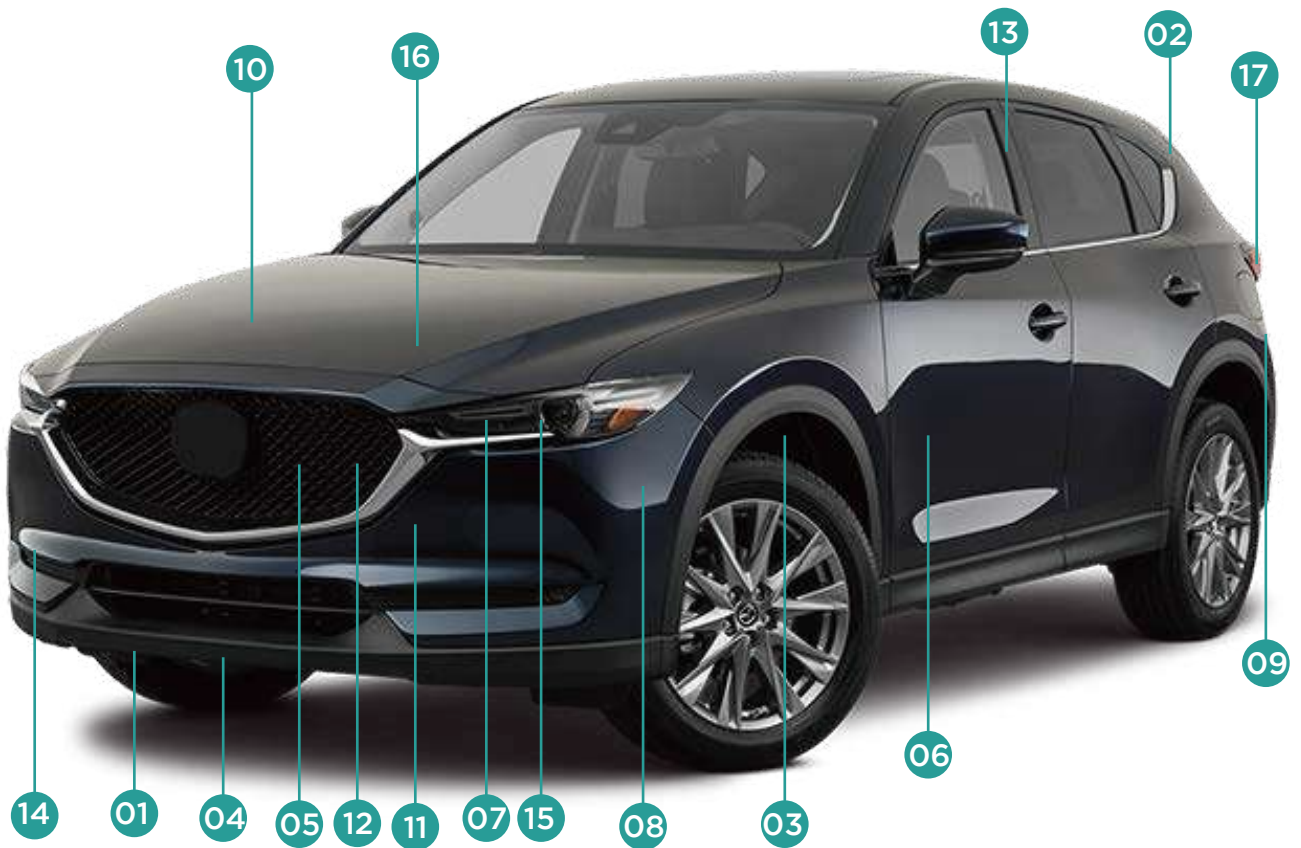

## SEDAN



### — WHEELARCH (MAZDA 6 2012~2016)

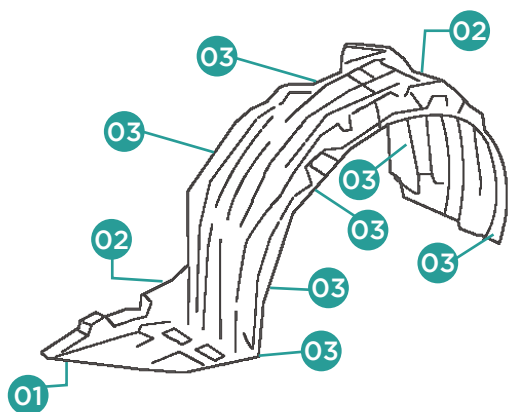

H2175



C1650



C1933

### — HOOD SILENCER (VOLKSWAGEN GOLF 6 2013~2021)

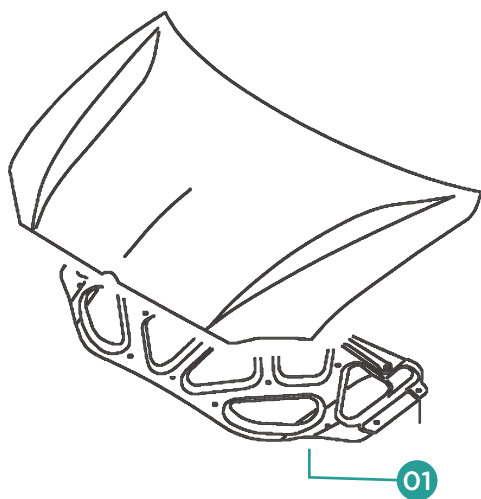

C1413

### — FRONT WINDSHIELD (ACURA CDX 2018~2020)

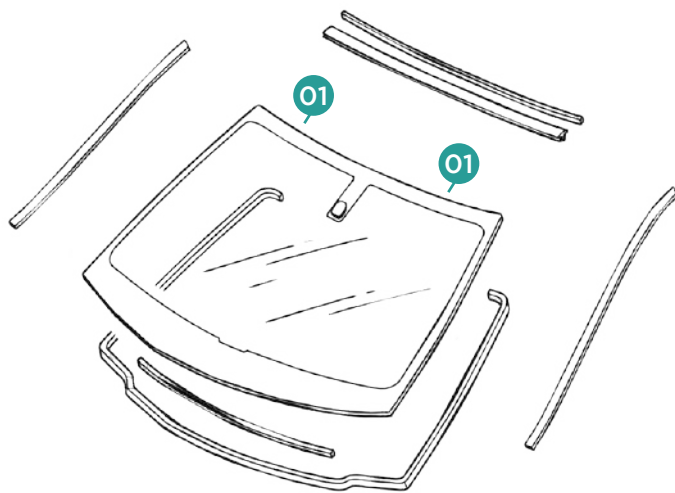

C3471

## ROCKER PANEL (HYUNDAI SONATA 2015~PRESENT)

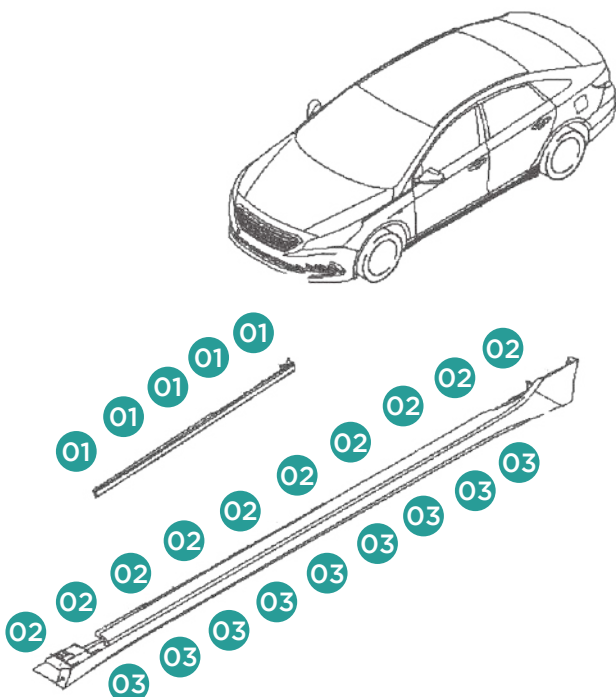

C3057



C1152



C1879

## HEAT SHIELD (SKODA CITIGO 2012~2020)

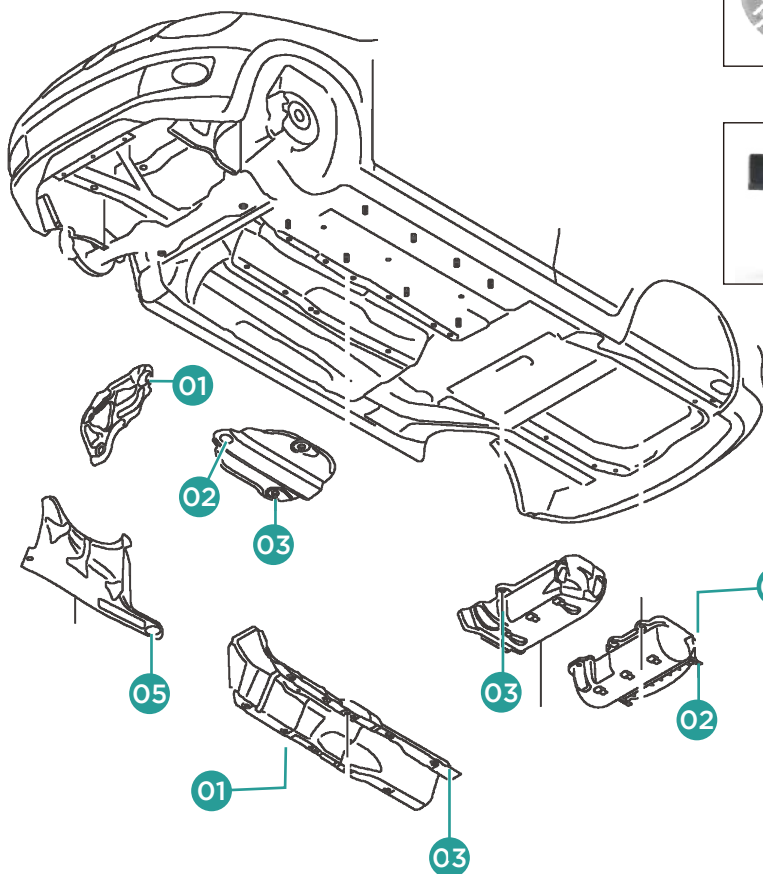

H1117



H2182



C3193



C0952



H2246

### GRILLE (For NISSAN SYLPHY 2012~2016)

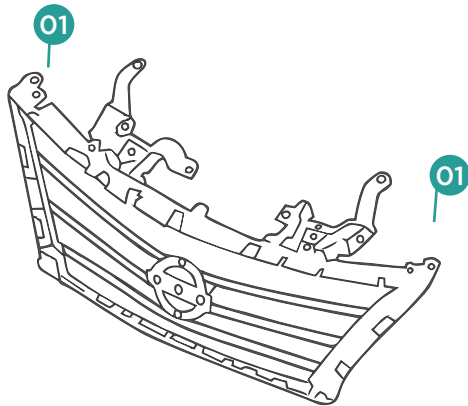

C0351

### ROOF (For VOLKSWAGEN JETTA 2020~2021)

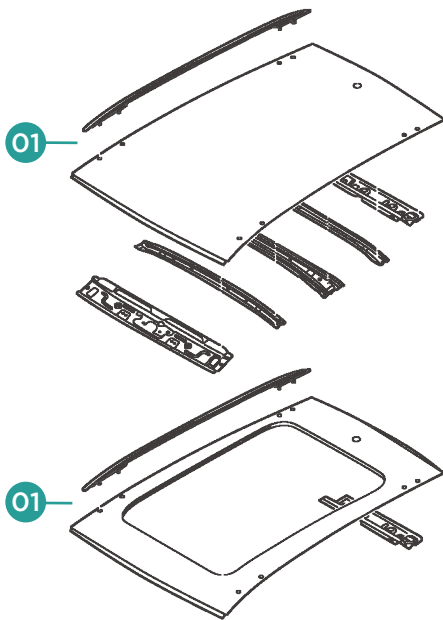

C1867

### DOOR WEATHERSTRIP (For HONDA ELYSION 2013~2016)

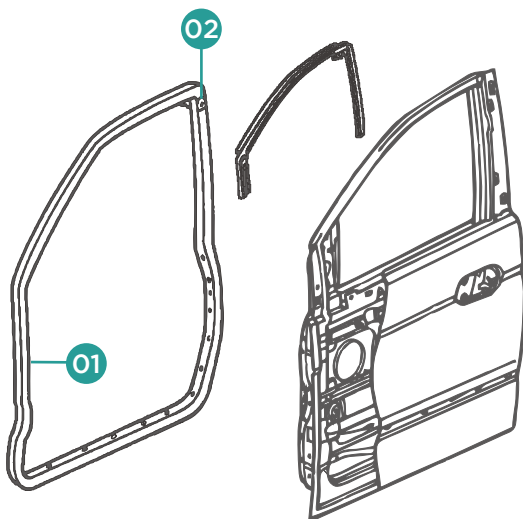

C1853



C1994

## FRONT BUMPER (For TOYOTA REIZ 2010~2017)

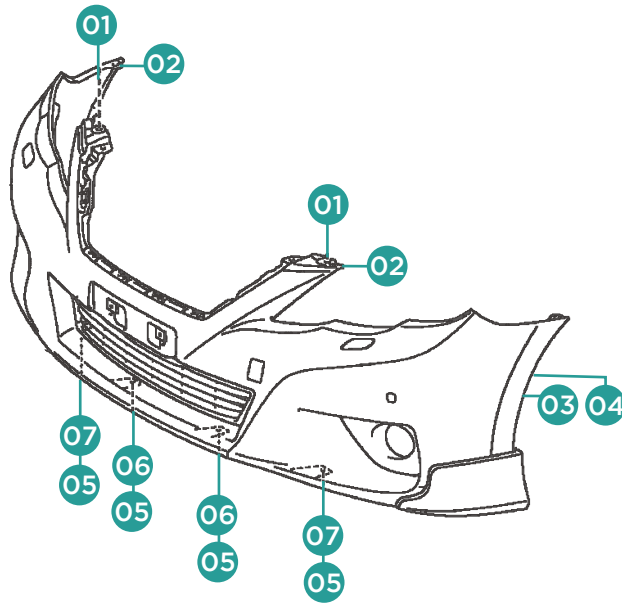

C0611



H2009



C0898 Pin



C0898 Body



H2007



C0366



H1146

## REAR BUMPER (For INFINITI Q50L 2014~PRESENT)

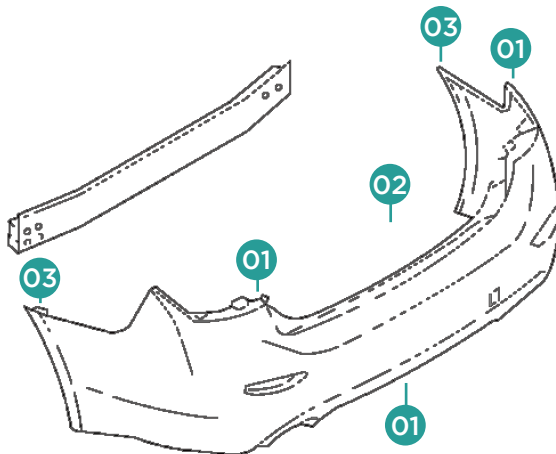

C0089



C1631



C1943

## REAR BUMPER (For INFINITI Q70 2018~PRESENT)

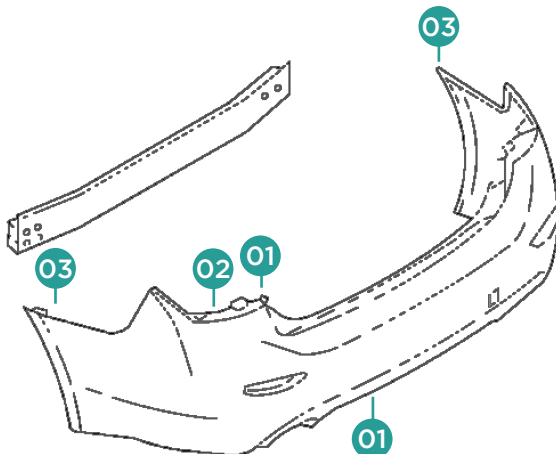

C0089



C1384



C1943



## FENDER (For SEAT TOLEDO 2013~2019)

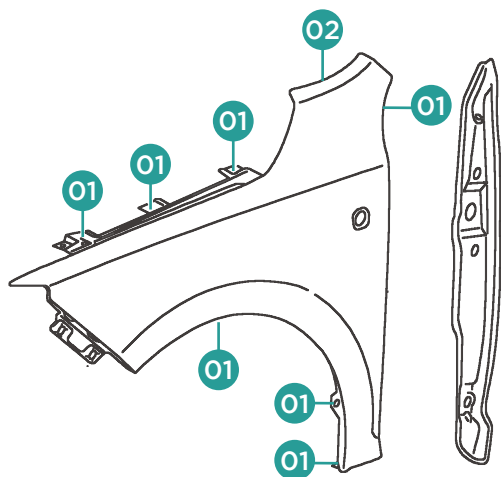

H2253



H2254

## TRUNK LINING (For ROEWE 950 2012~2019)

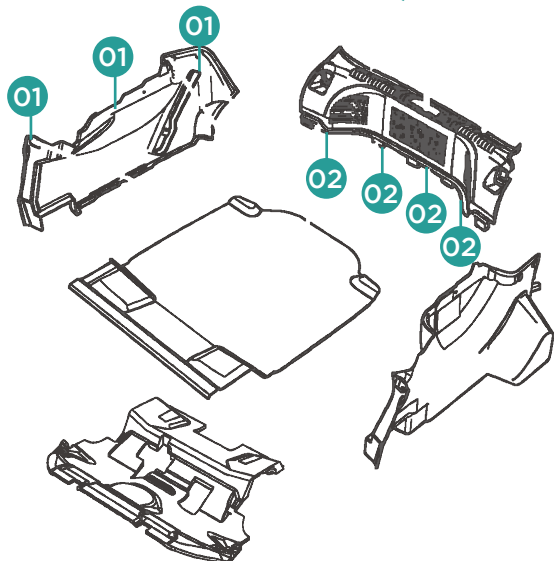

C1731



C3198

## AIR SPOILER (For FORD EDGE SUV 2010~PRESENT)

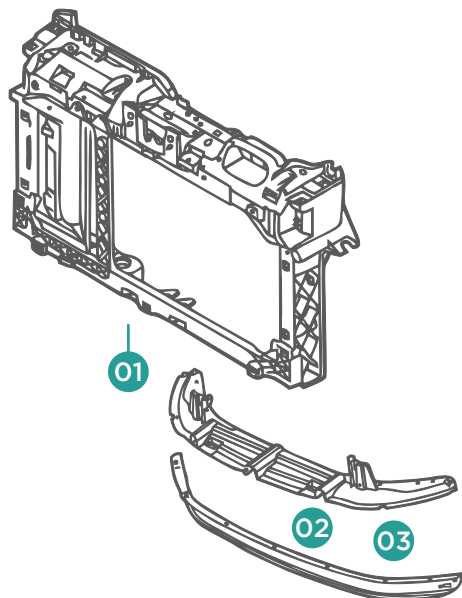

C0004



C1769



H2240

## FLOOR COVERING (For AUDI Q5L 2010~2020)

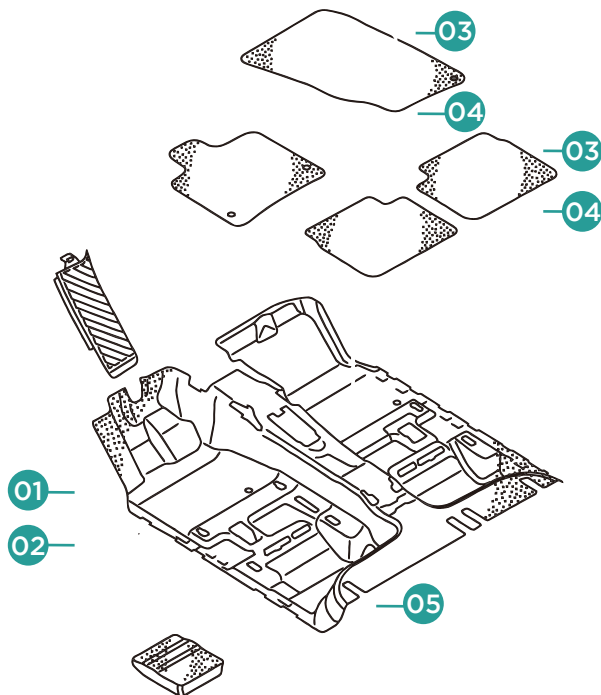

## ROCKER PANEL (For MINI CABRIO R52 COOPER)

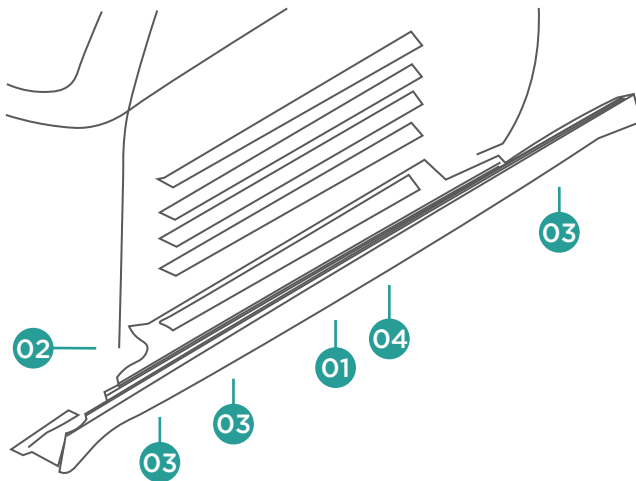

## TAIL LIGHT (For TOYOTA PRIUS V 2012~PRESENT)

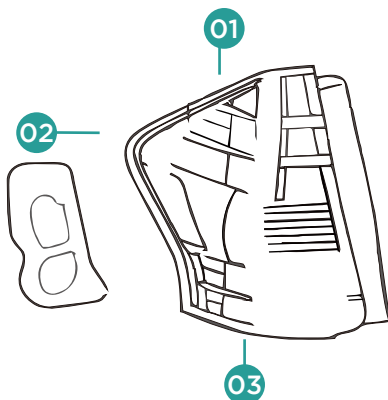

### — EMBLEM (For BMW 320i)

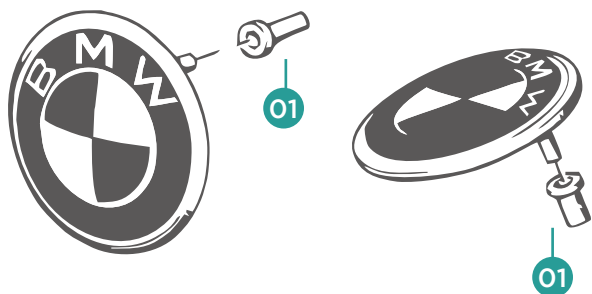

C3254

### — COWL (For HONDA CROSS TOUR 2012~2016)

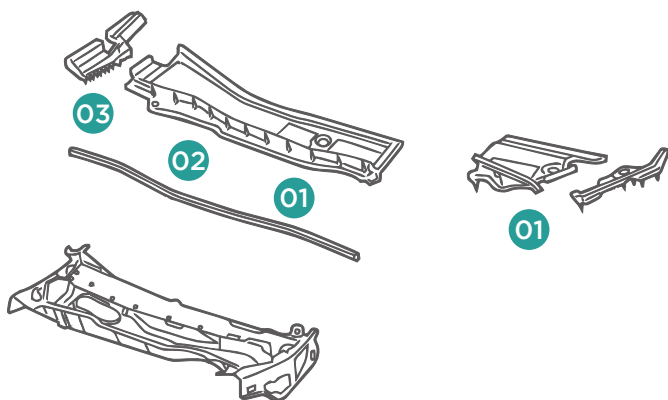

C1500



C1344



C0083

### — SEAT BELT (For VOLKSWAGEN GOLF 2002~2022)

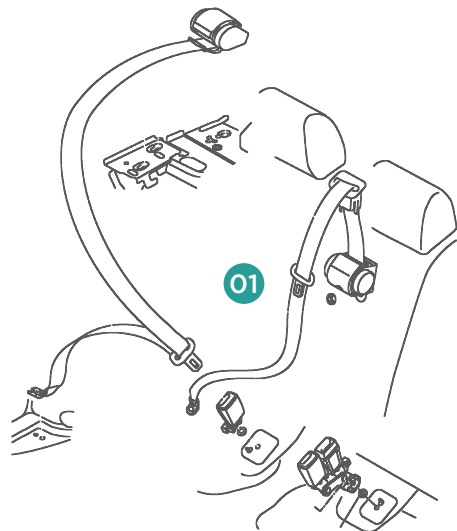

C3339

## LIFTGATE (For BENZ C 300 D)

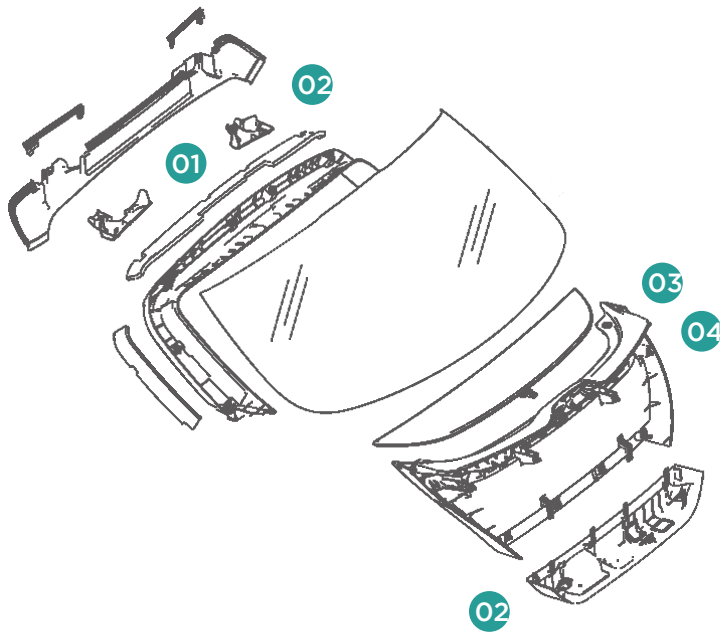

C3373



C3332



H2234



C3377

## PILLAR GARNISH (For VW POLO VIVO 2018~2022)

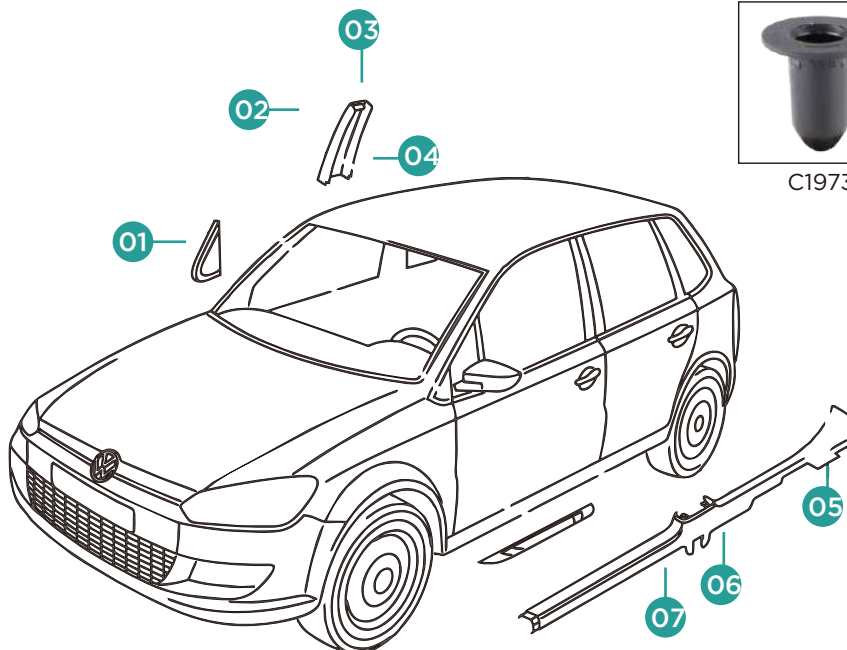

C3187



C3194



C1410



C1973



C3186



C1885



H2202

# FIR TREE RIVET

**Product No.:** C0004

**Material:** PA  
**Color:** Black / Grey  
**Position:** Wheelarch bumper



Product Details

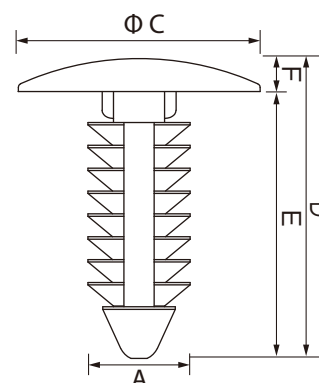
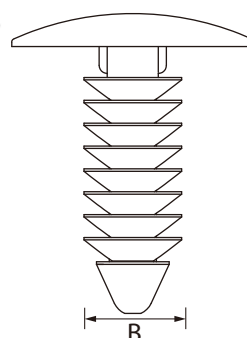

Part No.	Material	Color	mm						in					
			A	B	ΦC	D	E	F	A	B	ΦC	D	E	F
C1232	PA	Black/ Natural	3.45	2.90	5.50	19.60	18.70	0.90	0.135	0.113	0.215	0.764	0.729	0.035
C4074	PA	Black	3.95	3.50	8.70	13.20	11.60	1.60	0.154	0.137	0.339	0.515	0.452	0.062
C0415	PA	Black/ White	4.15	4.15	10.50	11.35	10.10	1.25	0.162	0.162	0.410	0.443	0.394	0.049
C0326	PA	Black	4.20	3.90	9.00	10.90	9.50	1.40	0.164	0.152	0.351	0.425	0.371	0.055
C3666	PA	Black	4.45	4.85	16.00	29.20	26.20	3.00	0.174	0.189	0.624	1.139	1.022	0.117
C0495	PA	Black	4.65	3.80	11.30	11.10	0.90	10.20	0.181	0.148	0.441	0.433	0.035	0.398
C0187	PA	Black/Grey	4.70	4.20	19.90	16.70	14.70	2.00	0.183	0.164	0.776	0.651	0.573	0.078
C0206	PA	Black/ Natural	4.70	4.60	11.10	13.15	12.25	0.90	0.183	0.179	0.433	0.513	0.478	0.035
C3459	PA	Black	4.70	4.70	12.00	18.00	16.00	2.00	0.183	0.183	0.468	0.702	0.624	0.078
C3533	PA	Black	4.70	4.70	9.00	12.45	10.95	1.50	0.183	0.183	0.351	0.486	0.427	0.059
C3475	PA	Black	4.75	4.75	11.00	8.85	7.10	1.75	0.185	0.185	0.429	0.345	0.277	0.068
C0153	PA	Black	4.80	4.80	13.25	18.25	16.10	2.15	0.187	0.187	0.517	0.712	0.628	0.084
C0223	PA	Black	4.80	4.70	11.80	13.00	11.15	1.85	0.187	0.183	0.460	0.507	0.435	0.072
C0858	PA	Dark gery	4.80	4.70	15.90	28.65	26.75	1.90	0.187	0.183	0.620	1.117	1.043	0.074
C3803	PA	Black	4.80	4.80	16.00	18.10	16.15	1.95	0.187	0.187	0.624	0.706	0.630	0.076
C0132	PA	Black	4.95	4.75	13.1x5.0	13.30	11.40	1.90	0.193	0.185	0.511x0.195	0.519	0.445	0.074
C0423	PA	Black/ White	5.00	4.80	11.00	17.20	15.30	1.90	0.195	0.187	0.429	0.671	0.597	0.074
C0476	PA	Grey/ Grey white	5.00	4.80	25.30	20.40	17.60	2.80	0.195	0.187	0.987	0.796	0.686	0.109
C0514	PA	Black	5.00	4.70	15.00	19.40	17.90	1.50	0.195	0.183	0.585	0.757	0.698	0.059
C0606	PA	Light green	5.10	4.20	13.0x4.8	11.85	9.95	1.90	0.199	0.164	0.507x0.187	0.462	0.388	0.074
C3424	PA	Beige	5.10	5.10	12.7x4.8	18.00	15.90	2.10	0.199	0.199	0.495x0.187	0.702	0.620	0.082
C0368	PA	Black	5.15	5.15	10.35	23.75	22.15	1.60	0.201	0.201	0.404	0.926	0.864	0.062
C0103	PA	Black	5.20	5.20	17.20	14.10	12.50	1.60	0.203	0.203	0.671	0.550	0.488	0.062
C3534	PA	Light green	5.40	5.40	12.6x7.4	18.00	15.55	2.45	0.211	0.211	0.491x0.289	0.702	0.606	0.096
C0503	PA	Black	5.50	5.10	19.90	9.15	7.55	1.60	0.215	0.199	0.776	0.357	0.294	0.062
C0003	PA	Black	5.60	5.15	18.90	19.00	17.40	1.60	0.218	0.201	0.737	0.741	0.679	0.062
C1317	PA	Black	5.60	5.60	9.00	14.90	13.30	1.60	0.218	0.218	0.351	0.581	0.519	0.062
C3165	PA	Black	5.60	5.60	10.75	9.75	7.95	1.80	0.218	0.218	0.419	0.380	0.310	0.070
C3401	PA	Black	5.60	5.60	10.95	9.80	8.10	1.70	0.218	0.218	0.427	0.382	0.316	0.066
C1151	PA	Black/ Yellow/ Brown	5.65	5.60	19.00	24.00	22.30	1.70	0.220	0.218	0.741	0.936	0.870	0.066



## FIR TREE RIVET

Part No.	Material	Color	mm						in					
			A	B	ΦC	D	E	F	A	B	ΦC	D	E	F
C3783	PA	Black	5.65	5.65	18.70	15.00	13.00	2.00	0.220	0.220	0.729	0.585	0.507	0.078
C0245	PA	Black	5.70	5.50	15.80	19.50	16.15	3.35	0.222	0.215	0.616	0.761	0.630	0.131
C1978	PA	Black	5.70	5.70	20.00	12.45	10.65	1.80	0.222	0.222	0.780	0.486	0.415	0.070
C3186	POM	Black	5.70	5.70	15.00	22.00	19.45	2.55	0.222	0.222	0.585	0.858	0.759	0.099
C3331	PA	Black	5.70	5.70	11.00	14.10	12.40	1.70	0.222	0.222	0.429	0.550	0.484	0.066
C3269	PA	Black	5.75	5.20	18.45	14.85	12.25	2.60	0.224	0.203	0.720	0.579	0.478	0.101
C1233	PA	Black/ Natural	5.80	5.10	10.90	18.90	17.40	1.50	0.226	0.199	0.425	0.737	0.679	0.059
C3398	PA	Black	5.80	5.80	9.85	12.80	11.75	1.05	0.226	0.226	0.384	0.499	0.458	0.041
C3506	PA	Black	5.80	4.80	12.00	12.00	10.00	2.00	0.226	0.187	0.468	0.468	0.390	0.078
C1675	PA	White	5.90	5.50	17.95	18.60	16.80	1.80	0.230	0.215	0.700	0.725	0.655	0.070
C1003	PA	Black	6.00	6.00	10.05	12.35	10.40	1.95	0.234	0.234	0.392	0.482	0.406	0.076
C1619	PA	White	6.00	6.00	17.95	10.95	9.95	1.00	0.234	0.234	0.700	0.427	0.388	0.039
C1652	PA	Brown	6.00	4.70	24.10	17.35	14.40	2.95	0.234	0.183	0.940	0.677	0.562	0.115
C3928	PA	Black	6.00	4.80	20.20	19.45	17.15	2.30	0.234	0.187	0.788	0.759	0.669	0.090
C0125	PA	Black	6.05	6.05	29.60	11.90	9.50	2.40	0.236	0.236	1.154	0.464	0.371	0.094
C3306	PA	Black	6.05	5.70	30.35	12.20	9.70	2.50	0.236	0.222	1.184	0.476	0.378	0.098
C0626	PA	Black	6.10	6.10	10.10	16.80	15.55	1.25	0.238	0.238	0.394	0.655	0.606	0.049
C0155	PA	Black	6.20	6.20	10.00	13.20	12.05	1.15	0.242	0.242	0.390	0.515	0.470	0.045
C0284	PA	Black	6.30	4.70	28.45	10.80	8.80	2.00	0.246	0.183	1.110	0.421	0.343	0.078
C0246	PA	Black	6.40	6.40	14.8x10.0	11.70	9.65	2.05	0.250	0.250	0.577x0.390	0.456	0.376	0.080
C0535	PA	Black	6.40	6.20	29.35	10.70	8.60	2.10	0.250	0.242	1.145	0.417	0.335	0.082
C0926	PA	Black	6.40	6.40	22.90	19.00	16.00	3.00	0.250	0.250	0.893	0.741	0.624	0.117
C0102	PA	Black	6.50	5.80	20.10	24.95	23.55	1.40	0.254	0.226	0.784	0.973	0.918	0.055
C1234	PA	Black/ Grey/ Natural	6.50	6.50	15.60	13.80	12.60	1.20	0.254	0.254	0.608	0.538	0.491	0.047
C3058	PA	Black	6.50	6.40	20.00	16.30	14.00	2.30	0.254	0.250	0.780	0.636	0.546	0.090
C3285	PA	Black	6.50	6.45	25.40	22.65	19.80	2.85	0.254	0.252	0.991	0.883	0.772	0.111
C3341	PA	Black	6.50	5.80	18.10	23.40	20.90	2.50	0.254	0.226	0.706	0.913	0.815	0.098
C0580	PA	Black	6.60	4.90	12.50	18.00	15.80	2.20	0.257	0.191	0.488	0.702	0.616	0.086
C0539	PA	Black	6.65	6.05	18.20	23.20	20.70	2.50	0.259	0.236	0.710	0.905	0.807	0.098
C0834	PA	Black	6.65	6.50	16.15	19.85	16.05	3.80	0.259	0.254	0.630	0.774	0.626	0.148
C1227	PA	Black	6.65	6.65	16.15	17.60	15.30	2.30	0.259	0.259	0.630	0.686	0.597	0.090
C1004	PA	Black	6.70	6.70	16.15	17.45	15.95	1.50	0.261	0.261	0.630	0.681	0.622	0.059
C3175	PA	Black	6.70	6.20	30.00	17.30	15.10	2.20	0.261	0.242	1.170	0.675	0.589	0.086
C3421	PA	Black	6.70	6.70	13.00	21.70	19.40	2.30	0.261	0.261	0.507	0.846	0.757	0.090
C3788	PA	Light brown	6.70	6.70	18.00	27.75	25.75	2.00	0.261	0.261	0.702	1.082	1.004	0.078
C1719	PA	Black/ Grey	6.75	6.75	30.10	16.60	13.55	3.05	0.263	0.263	1.174	0.647	0.528	0.119
C3224	PA	Black	6.75	6.60	22.15	13.90	11.40	2.50	0.263	0.257	0.864	0.542	0.445	0.098
C0007	PA	Black	6.80	5.90	12.70	25.35	23.85	1.50	0.265	0.230	0.495	0.989	0.930	0.059
C0021	PA	Black	6.80	6.10	14.00	11.40	9.00	2.40	0.265	0.238	0.546	0.445	0.351	0.094
C1891	PA	Black	6.80	6.80	19.95	14.30	11.75	2.55	0.265	0.265	0.778	0.558	0.458	0.099
C3017	PA	Black	6.80	6.20	20.20	15.50	13.30	2.15	0.265	0.242	0.788	0.605	0.519	0.084
C3160	PA	Black	6.80	6.80	16.10	17.15	16.05	1.10	0.265	0.265	0.628	0.669	0.626	0.043
C0377	PA	Black/Grey black	6.85	6.85	18.15	22.40	20.30	2.10	0.267	0.267	0.708	0.874	0.792	0.082

## FIR TREE RIVET

Part No.	Material	Color	mm						in					
			A	B	ΦC	D	E	F	A	B	ΦC	D	E	F
C1794	PA	Black	6.85	6.20	18.25	17.40	15.00	2.40	0.267	0.242	0.712	0.679	0.585	0.094
C3004	PA	Black	6.85	6.60	20.00	14.30	12.45	1.85	0.267	0.257	0.780	0.558	0.486	0.072
C0150	PA	Black	6.90	6.90	25.60	38.10	36.35	1.75	0.269	0.269	0.998	1.486	1.418	0.068
C0555	PA	Black	6.90	6.70	18.45	26.30	23.40	2.90	0.269	0.261	0.720	1.026	0.913	0.113
C1349	PA	Black/ Natural	6.90	6.80	15.80	16.70	14.60	2.10	0.269	0.265	0.616	0.651	0.569	0.082
C1110	PA	Black	6.95	4.20	12.70	17.70	15.90	1.80	0.271	0.164	0.495	0.690	0.620	0.070
C3906	POM	Black	6.95	6.95	23.10	16.55	14.15	2.40	0.271	0.271	0.901	0.645	0.552	0.094
C0140	PA	Black	7.00	6.25	19.10	13.50	12.50	1.00	0.273	0.244	0.745	0.527	0.488	0.039
C0242	PA	Black	7.00	7.00	12.30	12.55	11.05	1.50	0.273	0.273	0.480	0.489	0.431	0.059
C1618	PA	Black	7.00	7.00	12.60	20.60	18.90	1.70	0.273	0.273	0.491	0.803	0.737	0.066
C3434	PA	Black	7.00	6.75	44.65	26.55	23.45	3.10	0.273	0.263	1.741	1.035	0.915	0.121
C3536	PA	Black	7.00	7.00	12.80	14.80	13.20	1.60	0.273	0.273	0.499	0.577	0.515	0.062
C3844	PA	Black	7.00	5.60	18.20	12.30	10.40	1.90	0.273	0.218	0.710	0.480	0.406	0.074
C1840	PA	Black	7.05	7.05	12.70	17.70	16.10	1.60	0.275	0.275	0.495	0.690	0.628	0.062
C1797	PA	Black	7.10	7.10	17.95	18.60	16.80	1.80	0.277	0.277	0.700	0.725	0.655	0.070
C3878	PA	Black	7.10	7.10	17.30	17.80	14.85	2.95	0.277	0.277	0.675	0.694	0.579	0.115
C1131	PA	Black	7.15	7.15	17.85	21.05	19.60	1.45	0.279	0.279	0.696	0.821	0.764	0.057
C3316	PA	Light grey/ Black	7.20	7.00	18.50	13.60	10.80	2.80	0.281	0.273	0.722	0.530	0.421	0.109
C3654	PA	Black	7.20	5.40	18.85	16.70	15.65	1.05	0.281	0.211	0.735	0.651	0.610	0.041
C1838	PA	Grey	7.25	7.25	35.00	22.20	19.10	3.10	0.283	0.283	1.365	0.866	0.745	0.121
C0040	PA	Black	7.30	7.30	25.20	22.40	19.40	3.00	0.285	0.285	0.983	0.874	0.757	0.117
C3810	PA	Black	7.30	7.30	17.00	12.30	9.90	2.40	0.285	0.285	0.663	0.480	0.386	0.094
C0209	PA	Black	7.40	6.50	25.05	22.85	20.10	2.75	0.289	0.254	0.977	0.891	0.784	0.107
C0300	PA	Black	7.40	6.95	25.00	32.10	29.30	2.80	0.289	0.271	0.975	1.252	1.143	0.109
C1302	PA	White	7.40	7.40	12.35	19.60	17.80	1.80	0.289	0.289	0.482	0.764	0.694	0.070
C3456	PA	Black	7.40	7.40	25.40	16.95	15.55	1.40	0.289	0.289	0.991	0.661	0.606	0.055
C3904	PA	Natural	7.40	7.40	11.00	16.70	15.20	1.50	0.289	0.289	0.429	0.651	0.593	0.059
C0309	PA	Black	7.45	7.45	9.20	14.90	13.15	1.75	0.291	0.291	0.359	0.581	0.513	0.068
C0642	PA	Black	7.45	7.45	22.00	37.20	35.10	2.10	0.291	0.291	0.858	1.451	1.369	0.082
C3563	PA	Light brown	7.45	7.45	25.30	47.10	44.85	2.25	0.291	0.291	0.987	1.837	1.749	0.088
C4037	PA	Black	7.48	7.48	8.15	47.50	45.05	2.45	0.292	0.292	0.318	1.853	1.757	0.096
C1820	PA	Black	7.50	7.50	26.00	30.50	27.95	2.55	0.293	0.293	1.014	1.190	1.090	0.099
C3003	PA	Black	7.50	5.55	29.90	15.80	13.15	2.65	0.293	0.216	1.166	0.616	0.513	0.103
C3284	PA	Brown	7.50	7.50	15.15	24.90	22.35	2.55	0.293	0.293	0.591	0.971	0.872	0.099
C3617	PA	Natural	7.50	7.10	19.20	42.80	40.40	2.40	0.293	0.277	0.749	1.669	1.576	0.094
C0001	PA	Black	7.55	7.00	50.10	20.00	15.40	4.60	0.294	0.273	1.954	0.780	0.601	0.179
C0243	PA	Black	7.60	6.85	13.85	21.90	19.95	1.95	0.296	0.267	0.540	0.854	0.778	0.076
C0609	PA	Black	7.60	7.30	25.50	30.10	27.10	3.00	0.296	0.285	0.995	1.174	1.057	0.117
C0829	PA	Black	7.60	7.30	18.00	35.65	33.15	2.50	0.296	0.285	0.702	1.390	1.293	0.098
C0866	PA	Grey	7.60	7.24	17.70	37.20	34.65	2.55	0.296	0.282	0.690	1.451	1.351	0.099
C3271	PA	Black grey	7.60	7.60	25.50	30.30	27.80	2.50	0.296	0.296	0.995	1.182	1.084	0.098
C3273	PA	Grey/ Black	7.60	7.20	26.10	30.60	28.05	2.55	0.296	0.281	1.018	1.193	1.094	0.099
C3532	PA	Black	7.60	7.60	25.50	17.80	15.50	2.30	0.296	0.296	0.995	0.694	0.605	0.090

## FIR TREE RIVET

Part No.	Material	Color	mm						in					
			A	B	ΦC	D	E	F	A	B	ΦC	D	E	F
C1235	PA	Black/ Natural	7.65	7.25	18.95	16.40	15.55	0.85	0.298	0.283	0.739	0.640	0.606	0.033
C3447	PP	Black	7.65	7.65	42.00	20.35	17.15	3.20	0.298	0.298	1.638	0.794	0.669	0.125
C0208	PA	Black	7.70	6.80	25.40	41.10	38.10	3.00	0.300	0.265	0.991	1.603	1.486	0.117
C0413	PA	Black	7.70	7.50	17.70	17.50	15.30	1.80	0.300	0.293	0.690	0.683	0.597	0.070
C0414	PA	Grey	7.70	7.32	17.70	17.50	15.30	2.20	0.300	0.285	0.690	0.683	0.597	0.086
C0529	PA	White	7.70	7.50	17.85	17.70	15.30	2.40	0.300	0.293	0.696	0.690	0.597	0.094
C0643	PA	Black	7.70	7.70	25.40	19.40	14.20	5.20	0.300	0.300	0.991	0.757	0.554	0.203
C0679	PA	Black	7.70	7.25	17.80	49.70	46.60	3.00	0.300	0.283	0.694	1.938	1.817	0.117
C0815	PA	Grey/ Black	7.70	6.60	25.70	46.90	44.00	2.90	0.300	0.257	1.002	1.829	1.716	0.113
C1504	PA	Black	7.70	5.00	14.0x8.5	15.30	14.30	1.00	0.300	0.195	0.546x0.332	0.597	0.558	0.039
C1776	PA	Black	7.70	7.30	30.95	15.10	12.40	2.70	0.300	0.285	1.207	0.589	0.484	0.105
C3360	PA	Black	7.70	7.70	22.30	36.80	35.25	1.55	0.300	0.300	0.870	1.435	1.375	0.060
C3568	PA	Black	7.70	7.70	25.50	23.10	20.60	2.50	0.300	0.300	0.995	0.901	0.803	0.098
C0005	PA	Black/ Natural	7.75	7.40	17.80	17.55	15.25	2.30	0.302	0.289	0.694	0.684	0.595	0.090
C0528	PA	Black	7.75	7.75	22.05	29.50	27.70	1.80	0.302	0.302	0.860	1.151	1.080	0.070
C0990	PA	Grey	7.75	6.65	25.50	31.90	29.00	2.90	0.302	0.259	0.995	1.244	1.131	0.113
C3302	PA	Light brown	7.75	6.65	25.50	31.90	29.00	2.90	0.302	0.259	0.995	1.244	1.131	0.113
C0004	PA	Black/Grey/ Beige/ White	7.80	7.26	18.00	22.30	19.85	2.45	0.304	0.283	0.702	0.870	0.774	0.096
C0674	PA	Black/ Grey	7.80	6.60	18.90	28.50	27.00	1.50	0.304	0.257	0.737	1.112	1.053	0.059
C0826	PA	Black	7.80	7.20	12.80	17.00	15.70	1.30	0.304	0.281	0.499	0.663	0.612	0.051
C0827	PA	Black	7.80	7.60	21.00	26.50	24.30	2.20	0.304	0.296	0.819	1.034	0.948	0.086
C3044	PA	Black	7.80	7.50	18.00	46.50	44.05	2.45	0.304	0.293	0.702	1.814	1.718	0.096
C3359	PA	Black	7.80	7.45	34.90	26.00	22.60	3.30	0.304	0.291	1.361	1.014	0.881	0.129
C3722	PA	Black	7.80	6.25	32.25	19.75	17.00	2.75	0.304	0.244	1.258	0.770	0.663	0.107
C1238	PA	Black	7.84	6.70	19.00	22.40	20.60	1.80	0.306	0.261	0.741	0.874	0.803	0.070
C0582	PA	Black	7.85	7.50	17.90	29.40	26.80	2.10	0.306	0.293	0.698	1.147	1.045	0.082
C0186	PA	Black	7.90	7.55	25.12	29.75	28.15	1.60	0.308	0.294	0.980	1.160	1.098	0.062
C0410	PA	Black	7.90	7.90	32.25	18.00	14.20	3.80	0.308	0.308	1.258	0.702	0.554	0.148
C1883	PA	Dark gery	7.90	7.85	13.90	17.45	15.95	1.50	0.308	0.306	0.542	0.681	0.622	0.059
C3327	PA	Black	7.90	7.90	14.20	13.60	12.25	1.35	0.308	0.308	0.554	0.530	0.478	0.053
C3609	PA	Black	7.90	7.90	23.00	34.80	31.80	3.00	0.308	0.308	0.897	1.357	1.240	0.117
C3850	POM	Black	7.90	7.90	18.20	18.20	16.20	2.00	0.308	0.308	0.710	0.710	0.632	0.078
C4036	PA	Black	7.90	7.90	23.00	34.80	31.80	3.00	0.308	0.308	0.897	1.357	1.240	0.117
C0037	PA	Black	7.95	7.75	24.25	19.85	17.75	2.10	0.310	0.302	0.946	0.774	0.692	0.082
C1264	PA	Black	7.95	7.80	12.80	22.50	20.50	2.00	0.310	0.304	0.499	0.878	0.800	0.078
C1892	PA	Black	7.95	7.90	20.25	18.20	16.20	2.00	0.310	0.308	0.790	0.710	0.632	0.078
C0017	PA	Beige	8.00	7.80	24.40	20.00	17.95	2.05	0.312	0.304	0.952	0.780	0.700	0.080
C0104	PA	Black	8.00	6.50	18.20	23.70	22.05	1.65	0.312	0.254	0.710	0.924	0.860	0.064
C0420	PA	Beige	8.00	7.60	30.90	29.30	27.10	2.20	0.312	0.296	1.205	1.143	1.057	0.086
C0546	PP	Black	8.00	7.90	44.50	24.30	22.60	1.70	0.312	0.308	1.736	0.948	0.881	0.066
C1314	PA	Black	8.00	8.00	10.20	34.80	33.80	1.00	0.312	0.312	0.398	1.357	1.318	0.039
C1601	PA	Black/ Grey	8.00	7.85	30.20	19.95	18.30	2.15	0.312	0.306	1.178	0.778	0.714	0.084
C3046	PA	Black	8.00	5.40	13.1x5.0	12.30	10.45	1.85	0.312	0.211	0.511x0.195	0.480	0.408	0.072
C3283	PA	Grey	8.00	6.50	25.50	22.90	20.10	2.80	0.312	0.254	0.995	0.893	0.784	0.109
C0101	PA	Black	8.05	7.60	24.85	22.55	20.05	2.50	0.314	0.296	0.969	0.879	0.782	0.098

## FIR TREE RIVET

Part No.	Material	Color	mm						in					
			A	B	ΦC	D	E	F	A	B	ΦC	D	E	F
C0431	PA	Black	8.05	7.95	25.20	22.70	20.30	2.40	0.314	0.310	0.983	0.885	0.792	0.094
C3397	PA	Dark gery	8.05	8.05	15.90	23.90	21.85	2.05	0.314	0.314	0.620	0.932	0.852	0.080
C0042	PA	Black	8.10	7.80	19.50	37.80	34.60	3.20	0.316	0.304	0.761	1.474	1.349	0.125
C0138	PA	Beige	8.10	7.80	16.05	19.65	18.50	1.15	0.316	0.304	0.626	0.766	0.722	0.045
C1104	PA	Grey	8.10	8.10	18.30	20.60	17.50	3.10	0.316	0.316	0.714	0.803	0.683	0.121
C1112	PA	Black	8.10	8.00	23.80	20.90	17.90	3.00	0.316	0.312	0.928	0.815	0.698	0.117
C1987	PA	Black	8.10	7.80	14.10	26.95	25.15	1.80	0.316	0.304	0.550	1.051	0.981	0.070
C0478	PA	Black	8.15	6.33	19.50	34.75	31.95	2.80	0.318	0.247	0.761	1.355	1.246	0.109
C0479	PA	White	8.15	7.75	15.40	51.40	49.80	1.60	0.318	0.302	0.601	2.005	1.942	0.062
C0600	PA	Grey	8.15	6.33	19.50	34.75	31.95	2.80	0.318	0.247	0.761	1.355	1.246	0.109
C1303	PA	White	8.15	6.95	10.00	16.50	14.85	1.65	0.318	0.271	0.390	0.644	0.579	0.064
C0174	PA	Black	8.20	6.50	40.15	14.70	12.20	2.50	0.320	0.254	1.566	0.573	0.476	0.098
C0572	PA	Grey	8.20	8.20	32.90	22.80	19.80	3.00	0.320	0.320	1.283	0.889	0.772	0.117
C0942	PA	Black	8.20	8.20	20.50	23.05	20.45	2.60	0.320	0.320	0.800	0.899	0.798	0.101
C0301	PA	Black	8.30	7.40	19.00	24.75	22.05	2.70	0.324	0.289	0.741	0.965	0.860	0.105
C3167	PA	Black	8.30	7.85	26.10	11.70	9.80	1.90	0.324	0.306	1.018	0.456	0.382	0.074
C0428	PA	Black	8.35	8.00	31.80	31.90	29.80	2.10	0.326	0.312	1.240	1.244	1.162	0.082
C0036	PA	Black	8.40	8.00	19.20	23.55	21.75	1.80	0.328	0.312	0.749	0.918	0.848	0.070
C1007	PA	Grey	8.40	6.70	20.00	20.90	19.25	1.65	0.328	0.261	0.780	0.815	0.751	0.064
C3288	PA	Black	8.40	8.15	31.70	32.40	30.20	2.20	0.328	0.318	1.236	1.264	1.178	0.086
C3362	PA	Black	8.40	8.40	17.75	30.50	27.95	2.55	0.328	0.328	0.692	1.190	1.090	0.099
C3364	PA	Black	8.55	8.40	26.30	26.50	24.00	2.50	0.333	0.328	1.026	1.034	0.936	0.098
C3400	PA	Black	8.55	8.55	20.30	22.40	19.75	2.65	0.333	0.333	0.792	0.874	0.770	0.103
C0198	PA	Black/ Natural	8.60	7.80	18.85	31.95	29.45	2.50	0.335	0.304	0.735	1.246	1.149	0.098
C1237	PA	Black/ Grey/ Natural	8.60	8.30	19.00	23.50	21.05	2.45	0.335	0.324	0.741	0.917	0.821	0.096
C3215	POM	Grey	8.70	7.85	26.20	41.00	38.40	2.60	0.339	0.306	1.022	1.599	1.498	0.101
C0058	PA	Black	8.85	7.45	17.60	18.10	16.50	1.60	0.345	0.291	0.686	0.706	0.644	0.062
C3005	PA	Black	9.00	7.55	20.00	17.30	14.95	2.35	0.351	0.294	0.780	0.675	0.583	0.092
C1944	PA	Black	9.05	6.60	17.65	21.75	19.55	2.20	0.353	0.257	0.688	0.848	0.762	0.086
C3711	PA	Black	9.10	9.10	20.00	18.60	16.90	1.70	0.355	0.355	0.780	0.725	0.659	0.066
C1584	PA	Black	9.20	9.20	25.00	14.80	12.50	2.30	0.359	0.359	0.975	0.577	0.488	0.090
C1296	PA	Grey	9.30	9.20	18.00	27.90	25.90	2.00	0.363	0.359	0.702	1.088	1.010	0.078
C1843	PA	Black	9.30	7.70	15.90	21.25	19.85	1.40	0.363	0.300	0.620	0.829	0.774	0.055
C3309	PA	Black	9.45	9.10	22.25	22.95	19.65	3.30	0.369	0.355	0.868	0.895	0.766	0.129
C3343	PA	Black	9.50	9.50	25.40	20.95	18.45	2.50	0.371	0.371	0.991	0.817	0.720	0.098
C3281	PA	Black/ Grey	9.60	9.20	18.10	24.50	21.90	2.60	0.374	0.359	0.706	0.956	0.854	0.101
C0825	PA	Black	9.65	9.40	24.10	21.55	19.10	2.45	0.376	0.367	0.940	0.840	0.745	0.096
C1841	POM	Black	9.70	9.65	21.30	31.25	27.75	3.50	0.378	0.376	0.831	1.219	1.082	0.137
C0575	PA	Black	9.80	9.60	16.00	22.00	19.70	2.30	0.382	0.374	0.624	0.858	0.768	0.090
C1520	PA	Black	10.55	10.55	34.40	25.00	22.20	2.80	0.411	0.411	1.342	0.975	0.866	0.109
C1556	PA	Black	10.60	10.10	35.10	25.50	21.70	3.80	0.413	0.394	1.369	0.995	0.846	0.148
C3315	PA	Brown	10.60	10.35	22.00	22.20	19.70	2.50	0.413	0.404	0.858	0.866	0.768	0.098
C1307	PA	Black	10.70	10.70	22.80	29.40	25.30	4.10	0.417	0.417	0.889	1.147	0.987	0.160

## FIR TREE RIVET

Part No.	Material	Color	mm						in					
			A	B	ΦC	D	E	F	A	B	ΦC	D	E	F
C0105	PA	Black	10.90	10.90	22.70	39.60	36.60	3.00	0.425	0.425	0.885	1.544	1.427	0.117
C3028	PA	Grey	11.00	11.00	21.10	21.15	19.15	2.00	0.429	0.429	0.823	0.825	0.747	0.078
C3317	PA	Black	11.00	10.25	18.00	20.00	16.60	3.40	0.429	0.400	0.702	0.780	0.647	0.133
C0002	PA	Black/White/ Natural	11.10	10.30	25.00	23.80	21.15	2.65	0.433	0.402	0.975	0.928	0.825	0.103
C1498	PA	Black	11.10	11.10	23.40	19.00	16.25	2.75	0.433	0.433	0.913	0.741	0.634	0.107
C0207	PA	Black	11.20	7.20	20.95	32.00	28.30	3.70	0.437	0.281	0.817	1.248	1.104	0.144
C0436	PA	Black	11.40	10.78	21.30	23.80	20.20	3.60	0.445	0.420	0.831	0.928	0.788	0.140
C1309	PA	Grey	11.90	11.90	16.00	20.80	19.00	1.80	0.464	0.464	0.624	0.811	0.741	0.070
C0353	PA	Black	13.40	13.40	25.00	18.15	15.15	3.00	0.523	0.523	0.975	0.708	0.591	0.117

**Product No.: C0060**

**Material:** PA  
**Color:** Black  
**Position:** Door panel, wrangler



Product Details

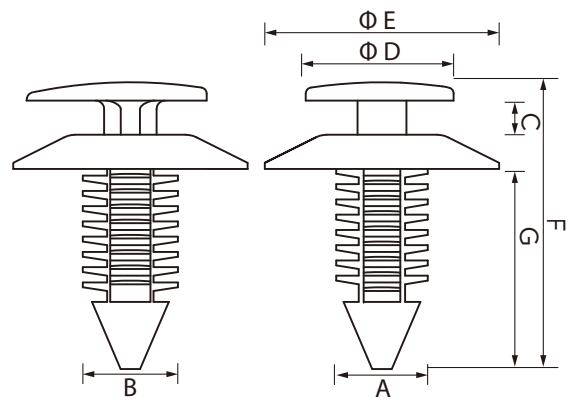

Part No.	Material	Color	mm							in						
			A	B	C	ΦD	ΦE	F	G	A	B	C	ΦD	ΦE	F	G
C1407	PA	Black	5.65	5.65	2.20	12.50	14.80	21.35	15.20	0.220	0.220	0.086	0.488	0.577	0.833	0.593
C1447	PA	Natural	5.75	5.75	3.00	12.80	16.00	30.00	24.60	0.224	0.224	0.117	0.499	0.624	1.170	0.959
C3350	POM	Natural	6.20	6.20	2.20	8.10	15.1x5.05	14.50	10.80	0.242	0.242	0.086	0.316	0.589x0.197	0.566	0.421
C3799	PA	Black	6.40	6.40	/	12x12	10.50	14.15	9.90	0.250	0.250	/	0.468x0.468	0.410	0.552	0.386
C1262	POM	White	6.60	6.60	2.70	14.60	16.35	20.85	15.50	0.257	0.257	0.105	0.569	0.638	0.813	0.605
C1121	PA	White	7.50	7.40	3.00	14.55	18.15	21.40	15.90	0.293	0.289	0.117	0.567	0.708	0.835	0.620
C0011	PA	Beige	7.75	7.70	1.55	23.70	24.40	23.05	17.55	0.302	0.300	0.060	0.924	0.952	0.899	0.684
C0516	PA	Beige	7.80	7.80	1.95	15.90	18.90	29.20	25.00	0.304	0.304	0.076	0.620	0.737	1.139	0.975
C0020	PA	Beige	7.90	6.40	2.00	23.45	24.00	23.60	18.10	0.308	0.250	0.078	0.915	0.936	0.920	0.706
C0060	PA	Black	7.90	7.70	2.75	14.80	19.25	23.70	16.30	0.308	0.300	0.107	0.577	0.751	0.924	0.636
C0131	PA	Beige	7.95	7.95	3.00	23.55	24.00	29.60	24.10	0.310	0.310	0.117	0.918	0.936	1.154	0.940
C0456	PA	Beige	8.00	6.30	1.80	22.95	24.10	30.70	25.80	0.312	0.246	0.070	0.895	0.940	1.197	1.006
C0302	PA	Beige	8.00	6.40	2.35	13.25	19.50	30.60	24.00	0.312	0.250	0.092	0.517	0.761	1.193	0.936
C1446	PA	Natural	8.00	7.80	3.00	13.20	16.10	21.10	15.00	0.312	0.304	0.117	0.515	0.628	0.823	0.585
C0038	PA	White	8.00	7.90	2.45	23.50	24.30	38.25	32.35	0.312	0.308	0.096	0.917	0.948	1.492	1.262
C3418	PA	Green	8.00	8.00	3.05	18.20	25.10	29.70	23.20	0.312	0.312	0.119	0.710	0.979	1.158	0.905



## FIR TREE RIVET

Part No.	Material	Color	mm							in						
			A	B	C	ΦD	ΦE	F	G	A	B	C	ΦD	ΦE	F	G
C0591	PA	White	8.05	7.95	2.40	12.90	24.90	30.50	24.85	0.314	0.310	0.094	0.503	0.971	1.190	0.969
C0151	PA	Beige	8.15	7.10	2.35	13.30	20.20	24.10	16.75	0.318	0.277	0.092	0.519	0.788	0.940	0.653
C0008	PA	Black	8.15	8.10	2.40	12.80	20.10	23.90	17.10	0.318	0.316	0.094	0.499	0.784	0.932	0.667
C0601	PA	White	8.30	7.70	1.00	13.15	19.30	34.80	29.50	0.324	0.300	0.039	0.513	0.753	1.357	1.151
C1659	PA	White	8.30	8.00	2.80	12.56x7.1	16.25x12.55	27.00	22.30	0.324	0.312	0.109	0.490x0.277	0.634x0.489	1.053	0.870
C3582	PA	Light grey	8.40	8.40	1.50	13.00	18.50	18.90	15.10	0.328	0.328	0.059	0.507	0.722	0.737	0.589
C0891	PA	Light green	8.60	8.60	2.60	13.5x9.3	14.55	23.25	17.75	0.335	0.335	0.101	0.527x0.363	0.567	0.907	0.692
C0631	PA	Beige/ Black	8.70	8.70	1.90	12.50	19.15	24.20	19.50	0.339	0.339	0.074	0.488	0.747	0.944	0.761
C3510	PA	Red	8.80	8.70	2.70	13.5x13.25	18.10	23.30	16.60	0.343	0.339	0.105	0.527x0.517	0.706	0.909	0.647
C3577	PA	Natural	8.80	8.80	2.60	17.65	19.30	36.10	31.20	0.343	0.343	0.101	0.688	0.753	1.408	1.217
C3751	POM	Natural	8.85	8.85	2.00	13.55	17.50	17.35	12.45	0.345	0.345	0.078	0.528	0.683	0.677	0.486
C0424	PA	Black	8.90	8.70	3.15	13.10	16.00	33.10	27.40	0.347	0.339	0.123	0.511	0.624	1.291	1.069
C1617	PA	Natural	8.95	7.00	2.95	13.00	18.00	21.70	17.30	0.349	0.273	0.115	0.507	0.702	0.846	0.675
C0458	PA	White	9.00	7.40	2.80	14.60	19.40	23.50	17.60	0.351	0.289	0.109	0.569	0.757	0.917	0.686
C1292	PA	White	9.05	8.85	3.15	14.40	16.00	22.20	17.00	0.353	0.345	0.123	0.562	0.624	0.866	0.663
C1668	PA	Yellow	9.40	9.40	2.80	12.90	19.50	24.30	16.50	0.367	0.367	0.109	0.503	0.761	0.948	0.644
C3640	PA	Light grey	9.40	9.40	2.75	12.90	19.50	18.50	10.85	0.367	0.367	0.107	0.503	0.761	0.722	0.423
C3697	PA	Grey	9.40	9.40	2.75	12.90	19.50	15.60	8.45	0.367	0.367	0.107	0.503	0.761	0.608	0.330

**Product No.:** C0170

**Material:** PA  
**Color:** Beige  
**Position:** Door panel

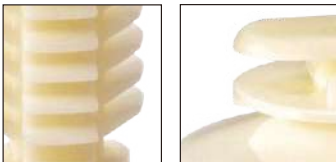

Product Details

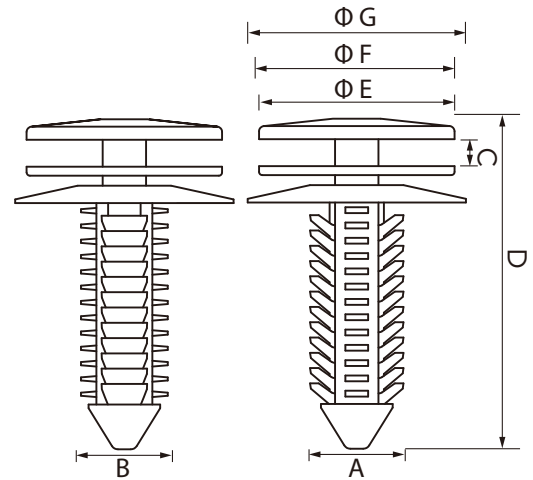

Part No.	Material	Color	mm							in						
			A	B	C	D	ΦE	ΦF	ΦG	A	B	C	D	ΦE	ΦF	ΦG
C1259	PA	Beige	7.30	7.25	1.80	23.70	18.15	18.15	18.15	0.285	0.283	0.070	0.924	0.708	0.708	0.708
C1293	PA	Natural	7.65	7.55	3.05	24.40	13.90	19.00	19.00	0.298	0.294	0.119	0.952	0.542	0.741	0.741
C0012	PA	Beige	7.75	7.30	2.05	20.80	19.30	19.30	19.30	0.302	0.285	0.080	0.811	0.753	0.753	0.753
C0147	PA	White	8.00	6.20	1.90	27.50	16.95	19.30	18.85	0.312	0.242	0.074	1.073	0.661	0.753	0.735
C0167	PA	White	8.00	7.70	2.95	27.30	12.35x7.2	12.85	17.55	0.312	0.300	0.115	1.065	0.482x0.281	0.501	0.684
C0427	PA	Beige	8.00	8.00	2.50	28.10	23.50	16.60	22.60	0.312	0.312	0.098	1.096	0.917	0.647	0.881
C0163	PA	White	8.10	6.25	2.50	28.00	12.0x6.3	12.00	13.00	0.316	0.244	0.098	1.092	0.468x0.246	0.468	0.507

## FIR TREE RIVET

Part No.	Material	Color	mm							in						
			A	B	C	D	ΦE	ΦF	ΦG	A	B	C	D	ΦE	ΦF	ΦG
C0172	PA	Beige	8.10	7.60	2.50	29.20	13.50	19.50	20.25	0.316	0.296	0.098	1.139	0.527	0.761	0.790
C0687	PA	White	8.10	8.00	2.50	40.10	18.30	18.30	20.70	0.316	0.312	0.098	1.564	0.714	0.714	0.807
C0139	PA	White	8.20	8.00	2.90	19.45	18.30	18.00	20.15	0.320	0.312	0.113	0.759	0.714	0.702	0.786
C0205	PA	White	8.20	6.40	2.55	27.70	14.95x7.25	15.00	22.95	0.320	0.250	0.099	1.080	0.583x0.283	0.585	0.895
C0635	PA	White	8.20	7.80	2.80	30.20	18.20	18.20	20.30	0.320	0.304	0.109	1.178	0.710	0.710	0.792
C0646	PA	Beige	8.20	8.00	2.75	28.15	18.30	18.30	20.45	0.320	0.312	0.107	1.098	0.714	0.714	0.798
C0637	PA	Beige	8.30	8.10	2.80	28.20	18.30	18.30	20.40	0.324	0.316	0.109	1.100	0.714	0.714	0.796
C0170	PA	Beige	8.60	8.00	2.70	31.60	18.20	18.20	20.20	0.335	0.312	0.105	1.232	0.710	0.710	0.788
C3308	PA	Yellow	9.00	9.00	2.80	22.00	14.65	15.10	21.30	0.351	0.351	0.109	0.858	0.571	0.589	0.831

**Product No.:** C1246

**Material:** PA  
**Color:** Black  
**Position:** Hood insulation, wheelarch fender



Product Details

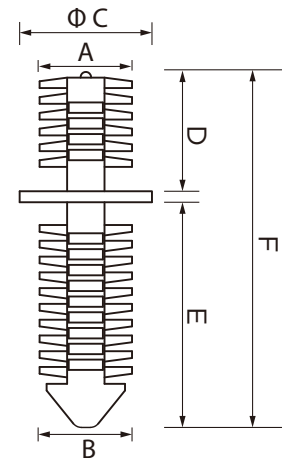

Part No.	Material	Color	mm						in					
			A	B	ΦC	D	E	F	A	B	ΦC	D	E	F
C0303	PA	Black	7.2x8.3	7.20	19.10	17.70	18.50	36.15	0.281x0.324	0.281	0.745	0.690	0.722	1.410
C1245	PA	Black	4.1x4.1	4.10	7.50	7.75	7.75	17.30	0.160x0.160	0.160	0.293	0.302	0.302	0.675
C1246	PA	Black	8.9x8.75	8.90	12.90	11.60	21.80	34.35	0.347x0.342	0.347	0.503	0.452	0.850	1.340



# FIR TREE RIVET



C0001

**Material:** PA  
**Color:** Black  
**Hood insulation**



C0002

**Material:** PA  
**Color:** Black/White/Natural  
**Radiator apron panel**



C0003

**Material:** PA  
**Color:** Black  
**Side panels and plating upholstery**



C0004

**Material:** PA  
**Color:** Black/Gray/Beige/White  
**Wheelarch bumper**



C0005

**Material:** PA  
**Color:** Black/ Natural  
**Fender & splash shield**



C0007

**Material:** PA  
**Color:** Black  
**Engine mount heat shield**

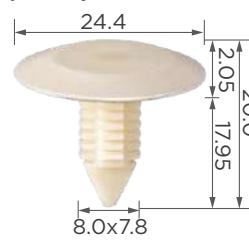

C0017

**Material:** PA  
**Color:** Beige  
**Interior trim panel**



C0021

**Material:** PA  
**Color:** Black  
**Front end fascia**



C0036

**Material:** PA  
**Color:** Black  
**Radiator air side & bumper cover**

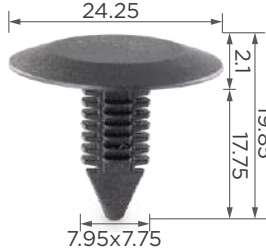

C0037

**Material:** PA  
**Color:** Black  
**Door trim panel**

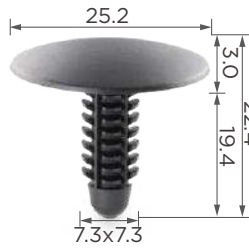

C0040

**Material:** PA  
**Color:** Black  
**Rear bumper fascia panel**



C0042

**Material:** PA  
**Color:** Black  
**Hood seal**



C0058

**Material:** PA  
**Color:** Black  
**Retainer**



C0101

**Material:** PA  
**Color:** Black  
**Door frame spacer bumper**



C0102

**Material:** PA  
**Color:** Black  
**Side panels and seat back**



C0103

**Material:** PA  
**Color:** Black  
**Cowl and Dash Panel, cowl vent**



C0104

**Material:** PA  
**Color:** Black  
**Trunk liner & rear seat carpet**



C0105

**Material:** PA  
**Color:** Black  
**Underbody panel & firewall insulation**



C0125

**Material:** PA  
**Color:** Black  
**Hood insulation**



C0132

**Material:** PA  
**Color:** Black/ Pink/ Red/ Blue  
**Door weatherstrip**

# FIR TREE RIVET

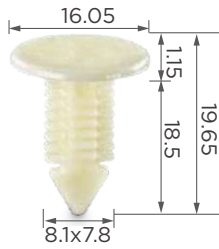

C0138

**Material:** PA  
**Color:** Beige  
**Roof headliner**



C0140

**Material:** PA  
**Color:** Black  
**Mud shield**



C0150

**Material:** PA  
**Color:** Black  
**Shield and trim panel**



C0153

**Material:** PA  
**Color:** Black  
**Recline cover and shield**



C0155

**Material:** PA  
**Color:** Black  
**Door weatherstrip**



C0174

**Material:** PA  
**Color:** Black  
**Hood insulation**



C0186

**Material:** PA  
**Color:** Black  
**Bumper cover**



C0187

**Material:** PA  
**Color:** Black/Grey  
**Center pillar garnish panel, floor mat**

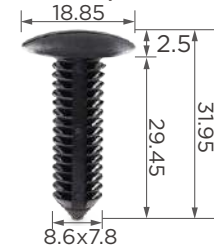

C0198

**Material:** PA  
**Color:** Black/ Natural  
**Bumper fascia**



C0206

**Material:** PA  
**Color:** Black/ Natural  
**Fascia**

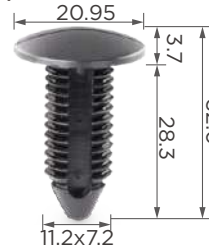

C0207

**Material:** PA  
**Color:** Black  
**Hood lock, front**

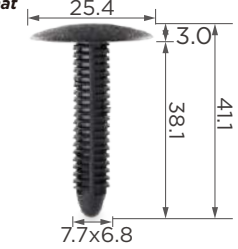

C0208

**Material:** PA  
**Color:** Black  
**Interior trim panel**



C0209

**Material:** PA  
**Color:** Black  
**Hood insulation**



C0223

**Material:** PA  
**Color:** Black  
**Surround weatherstrip**



C0242

**Material:** PA  
**Color:** Black  
**Radiator baffle & fender ledge**



C0243

**Material:** PA  
**Color:** Black  
**Radiator grille sight shield**



C0245

**Material:** PA  
**Color:** Black  
**Luggage compartment door**



C0246

**Material:** PA  
**Color:** Black  
**Door Weatherstrip**



C0284

**Material:** PA  
**Color:** Black  
**Hood insulation**



C0300

**Material:** PA  
**Color:** Black  
**Fender & side trim**

# FIR TREE RIVET



CO301

**Material:** PA  
**Color:** Black  
*Silding door & liftgate*



CO309

**Material:** PA  
**Color:** Black  
*Side moulding*



CO326

**Material:** PA  
**Color:** Black  
*Quarter upper trim & control trim panel*



CO353

**Material:** PA  
**Color:** Black  
*Front bumper fascia*



CO368

**Material:** PA  
**Color:** Black  
*Retainer GM15975244*



CO377

**Material:** PA  
**Color:** Black/ Grey/ Yellow/ Red  
*Rear trunk*



CO410

**Material:** PA  
**Color:** Black  
*Radiator grille*



CO413

**Material:** PA  
**Color:** Black  
*Fender and bumper shield*



CO414

**Material:** PA  
**Color:** Grey  
*Fender and bumper shield*



CO415

**Material:** PA  
**Color:** Black/ White  
*Door weatherstrip*

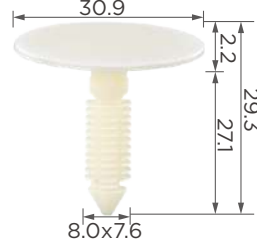

CO420

**Material:** PA  
**Color:** Beige  
*Door panel*



CO423

**Material:** PA  
**Color:** Black/ White  
*Weatherstrip & dash panel*



CO428

**Material:** PA  
**Color:** Black  
*Dash panel*



CO431

**Material:** PA  
**Color:** Black  
*Bumper fascia*



CO436

**Material:** PA  
**Color:** Black  
*Front end stone shield*

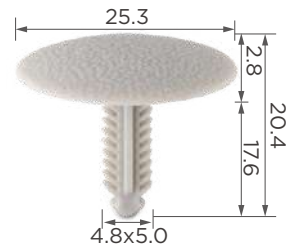

CO476

**Material:** PA  
**Color:** Grey/ Grey white  
*Bumper fascia*



CO478

**Material:** PA  
**Color:** Black  
*Pillar cover*

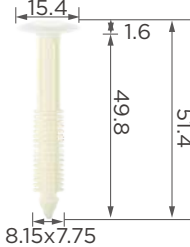

CO479

**Material:** PA  
**Color:** White  
*Hood seal*



CO495

**Material:** PA  
**Color:** Black  
*Panel*

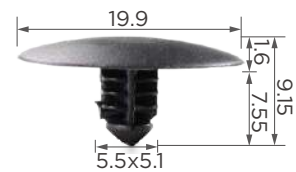

CO503

**Material:** PA  
**Color:** Black  
*Panel*



# FIR TREE RIVET



C0514

**Material:** PA  
**Color:** Black  
**Grille & shroud vent**



C0528

**Material:** PA  
**Color:** Black  
**Wheel arch cover**



C0529

**Material:** PA  
**Color:** White  
**Retainer**

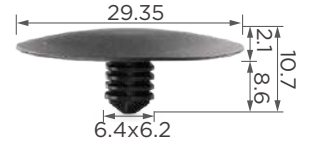

C0535

**Material:** PA  
**Color:** Black  
**Hood insulation**



C0539

**Material:** PA  
**Color:** Black  
**Carpet, front floor**



C0546

**Material:** PP  
**Color:** Black  
**Hood insulation**



C0555

**Material:** PA  
**Color:** Black  
**Bumper fascia and fender**

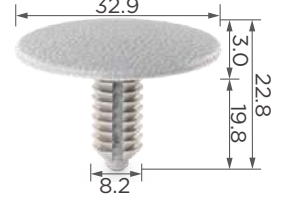

C0572

**Material:** PA  
**Color:** Grey  
**Headliner**



C0575

**Material:** PA  
**Color:** Black  
**Pedal, brake, box, panel**



C0580

**Material:** PA  
**Color:** Black  
**Steering gear**



C0582

**Material:** PA  
**Color:** Black  
**Seat, front bumper, engine, fender**

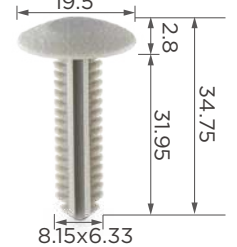

C0600

**Material:** PA  
**Color:** Grey  
**Door and trim panel**



C0606

**Material:** PA  
**Color:** Light green  
**Door panel**



C0609

**Material:** PA  
**Color:** Black  
**Headlight mounting, fender**



C0626

**Material:** PA  
**Color:** Black  
**Weatherstrip, seat**



C0642

**Material:** PA  
**Color:** Black  
**Bumper fascia**



C0643

**Material:** PA  
**Color:** Black  
**Cowl insulation**



C0674

**Material:** PA  
**Color:** Black/ Grey  
**Engine wiring harness, headliner**



C0679

**Material:** PA  
**Color:** Black  
**Rocker panel**



C0815

**Material:** PA  
**Color:** Black/ Grey  
**Garnish, trim panel**

# FIR TREE RIVET

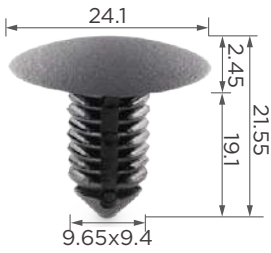

C0825

**Material:** PA  
**Color:** Black  
**Carpet, engine compartment**



C0826

**Material:** PA  
**Color:** Black  
**Retainer**



C0827

**Material:** PA  
**Color:** Black  
**Fender, floor**



C0829

**Material:** PA  
**Color:** Black  
**Fender flare, fender liner**

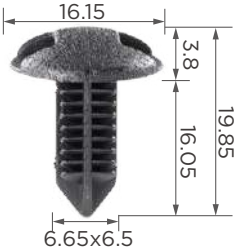

C0834

**Material:** PA  
**Color:** Black  
**Trunk lid, floor**



C0858

**Material:** PA  
**Color:** Dark grey  
**Rear tray, trunk**



C0866

**Material:** PA  
**Color:** Grey  
**Wheelarch**



C0926

**Material:** PA  
**Color:** Black  
**Grille, instrument panel**



C0942

**Material:** PA  
**Color:** Black  
**Trunk lining**

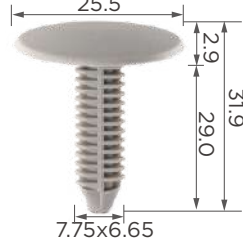

C0990

**Material:** PA  
**Color:** Grey  
**Headliner**



C1003

**Material:** PA  
**Color:** Black  
**Front door**



C1004

**Material:** PA  
**Color:** Black  
**Schema hood & front fender**



C1007

**Material:** PA  
**Color:** Grey  
**Roof interior**



C1104

**Material:** PA  
**Color:** Grey  
**Retainer**



C1110

**Material:** PA  
**Color:** Black  
**Retainer**



C1112

**Material:** PA  
**Color:** Black  
**Retainer**



C1131

**Material:** PA  
**Color:** Black  
**Retainer**

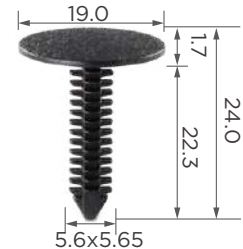

C1151

**Material:** PA  
**Color:** Black/ Yellow/ Brown  
**Roof interior**



C1227

**Material:** PA  
**Color:** Black  
**Retainer**

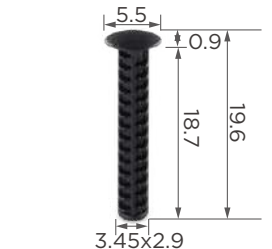

C1232

**Material:** PA  
**Color:** Black/ Natural  
**Retainer**

# FIR TREE RIVET



C1233

**Material:** PA  
**Color:** Black/ Natural  
**Retainer**



C1234

**Material:** PA  
**Color:** Black/ Grey/ Natural  
**Retainer**



C1235

**Material:** PA  
**Color:** Black/ Natural  
**Retainer**



C1237

**Material:** PA  
**Color:** Black/ Grey/ Natural  
**Retainer**



C1238

**Material:** PA  
**Color:** Black  
**Retainer**



C1264

**Material:** PA  
**Color:** Black  
**Retainer**

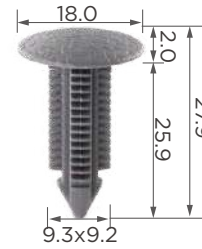

C1296

**Material:** PA  
**Color:** Grey  
**Side panel**

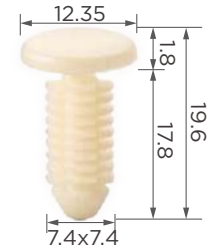

C1302

**Material:** PA  
**Color:** White  
**Retainer**

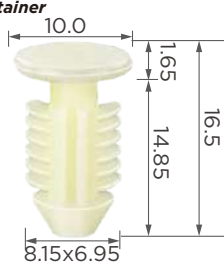

C1303

**Material:** PA  
**Color:** White  
**Retainer**



C1307

**Material:** PA  
**Color:** Black  
**Retainer**

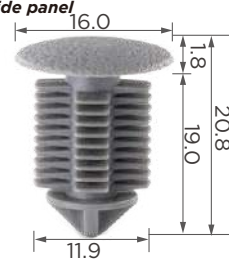

C1309

**Material:** PA  
**Color:** Grey  
**Panel**

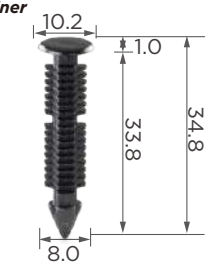

C1314

**Material:** PA  
**Color:** Black  
**Bumper**



C1317

**Material:** PA  
**Color:** Black  
**Weatherstrip**



C1349

**Material:** PA  
**Color:** Black/ Natural  
**Retainer**



C1498

**Material:** PA  
**Color:** Black  
**Radiator grille, door moulding**

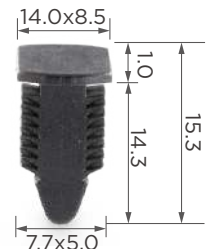

C1504

**Material:** PA  
**Color:** Black  
**Interior trim panel**



C1520

**Material:** PA  
**Color:** Black  
**Engine cover, wheelarch liner**



C1556

**Material:** PA  
**Color:** Black  
**Bumper, wheelarch, rear trunk**

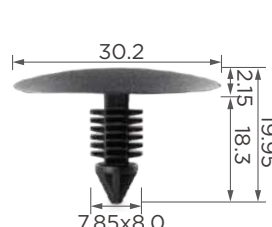

C1601

**Material:** PA  
**Color:** Black /Grey  
**Retainer**



C1618

**Material:** PA  
**Color:** Black  
**Hood**

# FIR TREE RIVET



C1619

**Material:** PA  
**Color:** White  
**Retainer**

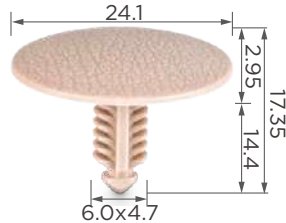

C1652

**Material:** PA  
**Color:** Brown  
**Retainer**



C1675

**Material:** PA  
**Color:** White  
**Door frame spacer bumper**



C1719

**Material:** PA  
**Color:** Black/ Grey  
**Hood**



C1776

**Material:** PA  
**Color:** Black  
**Retainer**



C1794

**Material:** PA  
**Color:** Black  
**Side trim panel, trunk cover**



C1797

**Material:** PA  
**Color:** Black  
**Hood insulation, wheelarch fender**



C1820

**Material:** PA  
**Color:** Black  
**Trunk, wheelarch cover**



C1838

**Material:** PA  
**Color:** Grey  
**Interior roof headliner**



C1840

**Material:** PA  
**Color:** Black  
**Fascia**



C1841

**Material:** PA  
**Color:** Black  
**Bumper fascia, spare tire carrier, heat shield**



C1843

**Material:** PA  
**Color:** Black  
**Rear bumper, interior**



C1883

**Material:** PA  
**Color:** Dark grey  
**Trunk garnish**



C1891

**Material:** PA  
**Color:** Black  
**Radiator panel**

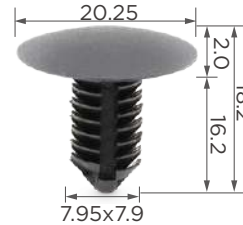

C1892

**Material:** PA  
**Color:** Black  
**Seat, interior trim panel**



C1944

**Material:** PA  
**Color:** Black  
**Front bumper**



C1978

**Material:** PA  
**Color:** Black  
**Trunk, rear window shelf**

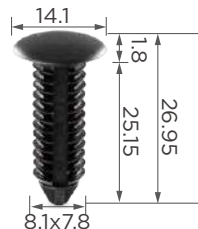

C1987

**Material:** PA  
**Color:** Black  
**Trunk, rear window shelf**



C3003

**Material:** PA  
**Color:** Black  
**Radiator grille panel**



C3004

**Material:** PA  
**Color:** Black  
**Trunk lid, front hood**

# FIR TREE RIVET



**C3005**

**Material:** PA  
**Color:** Black  
**Retainer**



**C3017**

**Material:** PA  
**Color:** Black  
**Retainer**

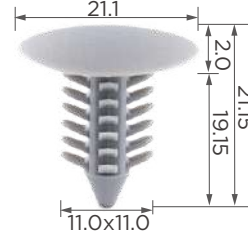

**C3028**

**Material:** PA  
**Color:** Grey  
**Retainer**



**C3044**

**Material:** PA  
**Color:** Black  
**Rocker panel**



**C3046**

**Material:** PA  
**Color:** Black  
**Front bumper, hood seat**

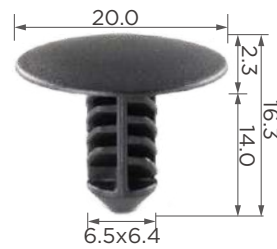

**C3058**

**Material:** PA  
**Color:** Black  
**Hood panel**

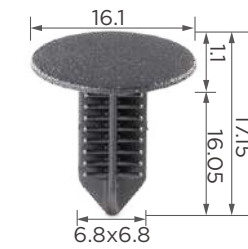

**C3160**

**Material:** PA  
**Color:** Black  
**Hood and front fender**



**C3165**

**Material:** PA  
**Color:** Black  
**Door seal**

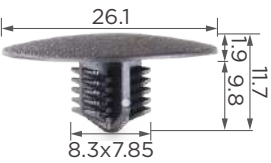

**C3167**

**Material:** PA  
**Color:** Black  
**Hood, engine**



**C3175**

**Material:** PA  
**Color:** Black  
**Hood, front bumper**



**C3186**

**Material:** POM  
**Color:** Black  
**Pillar, door, rocker panel**



**C3215**

**Material:** POM  
**Color:** Grey  
**Interior**



**C3224**

**Material:** PA  
**Color:** Black  
**Radiator grille**



**C3269**

**Material:** PA  
**Color:** Black  
**Radiator, back trunk**



**C3271**

**Material:** PA  
**Color:** Black grey  
**Retainer**



**C3273**

**Material:** PA  
**Color:** Grey/ Black  
**Roof**



**C3281**

**Material:** PA  
**Color:** Black/ Grey  
**Retainer**



**C3283**

**Material:** PA  
**Color:** Grey  
**Trim panel, hood insulation**



**C3284**

**Material:** PA  
**Color:** Brown  
**Door**



**C3285**

**Material:** PA  
**Color:** Black  
**Shield**



# FIR TREE RIVET



**C3288**

**Material:** PA  
**Color:** Grey  
**Retainer**



**C3302**

**Material:** PA  
**Color:** Light brown  
**Retainer**



**C3306**

**Material:** PA  
**Color:** Black  
**Hood insulation**



**C3309**

**Material:** PA  
**Color:** Black  
**Rear panel**



**C3315**

**Material:** PA  
**Color:** Light brown  
**Roof**



**C3316**

**Material:** PA  
**Color:** Light grey/ Black  
**Roof**



**C3317**

**Material:** PA  
**Color:** Black  
**Rear side, interior panel**



**C3327**

**Material:** PA  
**Color:** Black  
**Hood, seat**



**C3331**

**Material:** PA  
**Color:** Black  
**Wheelarch, seat, brake**



**C3341**

**Material:** PA  
**Color:** Black  
**Grille, interior**

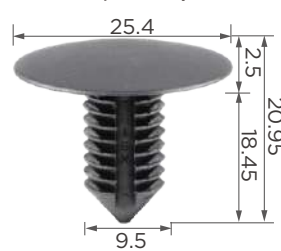

**C3343**

**Material:** PA  
**Color:** Black  
**Trunk**

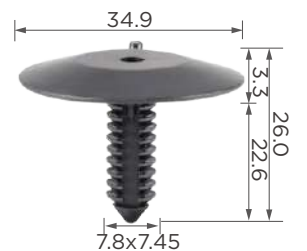

**C3359**

**Material:** PA  
**Color:** Black  
**Trunk**

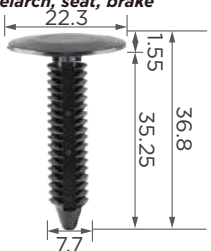

**C3360**

**Material:** PA  
**Color:** Black  
**Trunk**



**C3362**

**Material:** PA  
**Color:** Black  
**Trunk**



**C3364**

**Material:** PA  
**Color:** Black  
**Wheelarch**



**C3397**

**Material:** PA  
**Color:** Dark grey  
**Retainer**



**C3398**

**Material:** PA  
**Color:** Black  
**Carpet, door panel**



**C3400**

**Material:** PA  
**Color:** Black  
**Fender, rear aperture**



**C3401**

**Material:** PA  
**Color:** Black  
**Weatherstrip, door panel**



**C3421**

**Material:** PA  
**Color:** Black  
**Retainer**

# FIR TREE RIVET



C3424

**Material:** PA  
**Color:** Beige  
**Door weatherstrip**



C3434

**Material:** PA  
**Color:** Black  
**Bumper**



C3447

**Material:** PA  
**Color:** Black  
**Hood**



C3456

**Material:** PA  
**Color:** Black  
**Retainer**



C3459

**Material:** PA  
**Color:** Black  
**Retainer**



C3475

**Material:** PA  
**Color:** Black  
**Seat, armbox, bumper, hood**



C3506

**Material:** PA  
**Color:** Black  
**Air duct**



C3532

**Material:** PA  
**Color:** Black  
**Seat, bumper, wheelarch**



C3533

**Material:** PA  
**Color:** Black  
**Trunk**



C3534

**Material:** PA  
**Color:** Light green  
**Door weatherstrip**



C3536

**Material:** PA  
**Color:** Black  
**Cylinder cap**

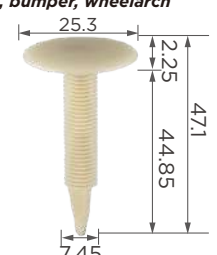

C3563

**Material:** PA  
**Color:** Light brown  
**Rear bumper**



C3568

**Material:** PA  
**Color:** Black  
**Rear wheelhouse silencer**

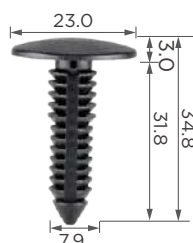

C3609

**Material:** PA  
**Color:** black  
**Fir tree clip**



C3617

**Material:** PA  
**Color:** Natural  
**Fir tree clip**

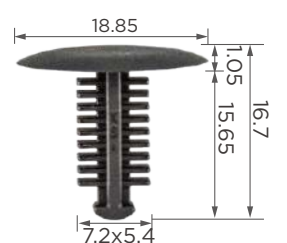

C3654

**Material:** PA  
**Color:** Black  
**Liftgate, rear panel**



C3666

**Material:** PA  
**Color:** Black  
**Front bumper**



C3711

**Material:** PA  
**Color:** Black  
**Rocker panel, Luggage interior trim panel, pillar, carpet**



C3722

**Material:** PA  
**Color:** black  
**Hood insulator**

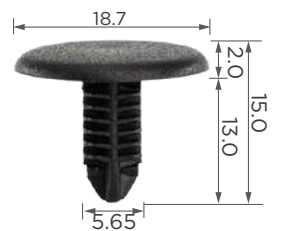

C3783

**Material:** PA  
**Color:** Black  
**Fir tree rivet**

# FIR TREE RIVET

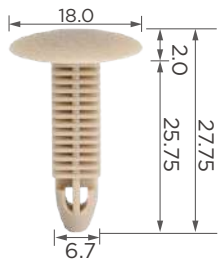

C3788

**Material:**  
Color: Light brown  
*Rear panel, luggage rack*



C3803

**Material:** PA  
**Color:** Black  
*Upper package tray asy*

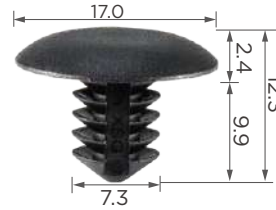

C3810

**Material:** PA  
**Color:** black  
*Fir tree clip*

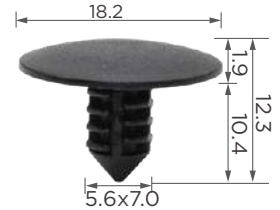

C3844

**Material:** PA  
**Color:** black  
*Fir tree clip*

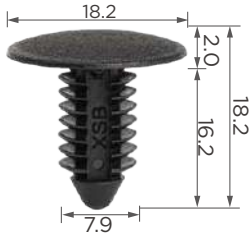

C3850

**Material:** PA  
**Color:** Black  
*Under shield, Roof*



C3878

**Material:** PA  
**Color:** Black  
*Car component*



C3904

**Material:** PA  
**Color:** Natural  
*Fir tree rivet*

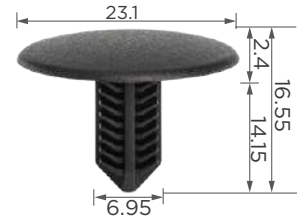

C3906

**Material:** POM  
**Color:** Black  
*Hood insulator, tunnel outer*



C3928

**Material:** PA  
**Color:** Black  
*Carpet, roof, tailgate interior*



C4036

**Material:** PA  
**Color:** Black  
*Fir tree rivet*



C4037

**Material:** PA  
**Color:** Black  
*Fir tree rivet*



C4074

**Material:** PA  
**Color:** Black  
*Fir tree clip*

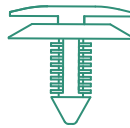

C0008

**Material:** PA  
**Color:** Black  
*Door panel*



C0011

**Material:** PA  
**Color:** Beige  
*Switch, door panel*



C0020

**Material:** PA  
**Color:** Beige  
*Door panel*



C0038

**Material:** PA  
**Color:** White  
*Seat, lamp*

# FIR TREE RIVET



**C0060**

**Material:** PA  
**Color:** Black  
**Door panel, fullhard door, wrangler**



**C0131**

**Material:** PA  
**Color:** Beige  
**Door panel**



**C0151**

**Material:** PA  
**Color:** Beige  
**Door panel**

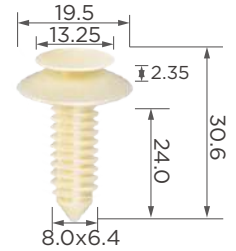

**C0302**

**Material:** PA  
**Color:** Beige  
**Door panel**

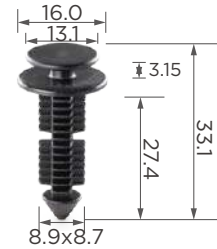

**C0424**

**Material:** PA  
**Color:** Black  
**Door panel**

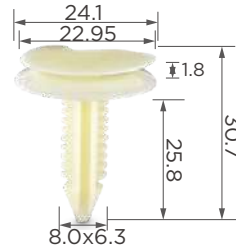

**C0456**

**Material:** PA  
**Color:** Beige  
**Door panel**



**C0458**

**Material:** PA  
**Color:** White  
**Fender, roof, floor**

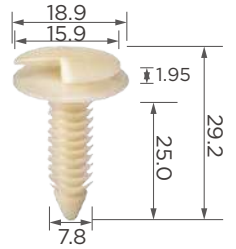

**C0516**

**Material:** PA  
**Color:** Beige  
**Door panel**



**C0591**

**Material:** PA  
**Color:** White  
**Door panel**

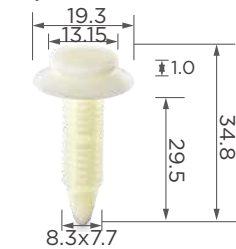

**C0601**

**Material:** PA  
**Color:** White  
**Door panel**



**C0631**

**Material:** PA  
**Color:** Beige/ Black  
**Door panel**



**C0891**

**Material:** PA  
**Color:** Light green  
**Door panel**



**C1121**

**Material:** PA  
**Color:** White  
**Door panel**



**C1262**

**Material:** POM  
**Color:** White  
**Mounting door panel**

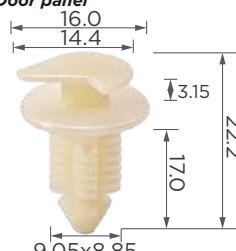

**C1292**

**Material:** PA  
**Color:** White  
**Door panel**



**C1407**

**Material:** PA  
**Color:** Black  
**Floor, roof, rear panel, pillar**



**C1446**

**Material:** PA  
**Color:** Natural  
**Rear panel**

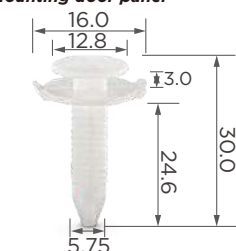

**C1447**

**Material:** PA  
**Color:** Natural  
**Pillar**



**C1617**

**Material:** PA  
**Color:** Natural  
**Door panel**



**C1659**

**Material:** PA  
**Color:** White  
**Door panel**

# FIR TREE RIVET

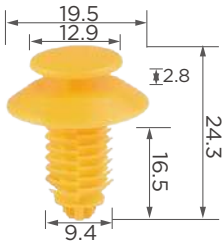

C1668

**Material:** PA  
**Color:** Yellow  
*Side moulding, Rear plate*



C3577

**Material:** PA  
**Color:** Natural  
*Fir tree clip*



C3751

**Material:** POM  
**Color:** Natural  
*Rocker panel, air suspension control, electrics*



C3350

**Material:** POM  
**Color:** Natural  
*Door panel*



C3582

**Material:** PA  
**Color:** Light grey  
*Fir tree clip*

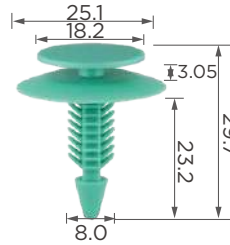

C3418

**Material:** PA  
**Color:** Green  
*Door panel*



C3640

**Material:** PA  
**Color:** Light grey  
*Fir tree clip*

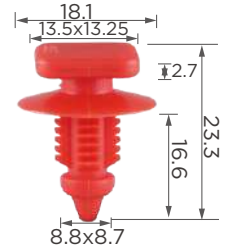

C3510

**Material:** PA  
**Color:** Red  
*Pillar, side moulding*

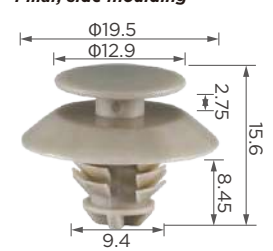

C3697

**Material:** PA  
**Color:** Grey  
*Door panel*

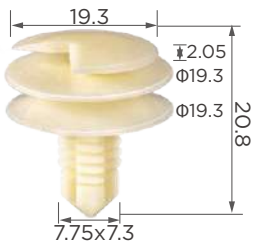
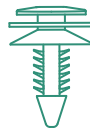

C0012

**Material:** PA  
**Color:** Beige  
*Door panel*



C0139

**Material:** PA  
**Color:** White  
*Door panel*



C0147

**Material:** PA  
**Color:** White  
*Door panel*



C0163

**Material:** PA  
**Color:** White  
*Door panel*



# FIR TREE RIVET

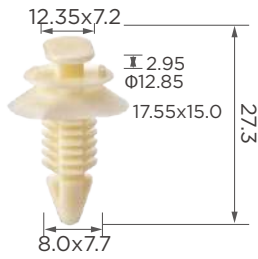

C0167

**Material:** PA  
**Color:** White  
**Retainer**

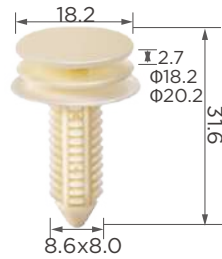

C0170

**Material:** PA  
**Color:** Beige  
**Panel**

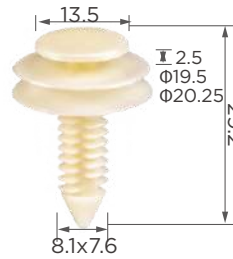

C0172

**Material:** PA  
**Color:** Beige  
**Bumper**

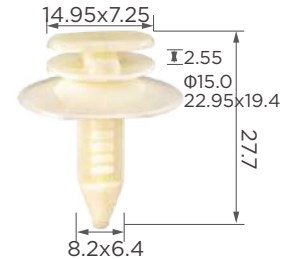

C0205

**Material:** PA  
**Color:** White  
**Weatherstrip**

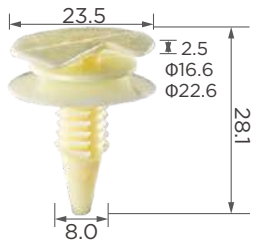

C0427

**Material:** PA  
**Color:** Beige  
**Retainer**



C0635

**Material:** PA  
**Color:** White  
**Radiator grille, door moulding**



C0637

**Material:** PA  
**Color:** Beige  
**Interior trim panel**



C0646

**Material:** PA  
**Color:** Beige  
**Engine cover, wheelarch liner**

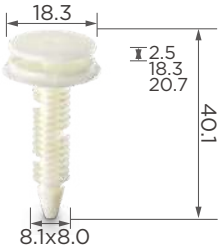

C0687

**Material:** PA  
**Color:** White  
**Bumper, wheelarch, rear trunk**



C1259

**Material:** PA  
**Color:** Green  
**Retainer**



C1293

**Material:** PA  
**Color:** Natural  
**Retainer**

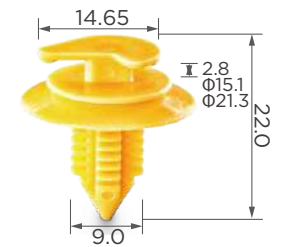

C3308

**Material:** PA  
**Color:** Yellow  
**Hood**

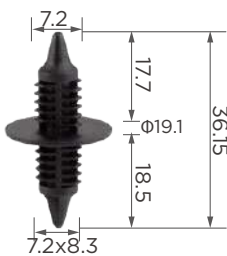

C0303

**Material:** PA  
**Color:** Black  
**Retainer**



C1245

**Material:** PA  
**Color:** Black  
**Side trim panel, trunk cover**

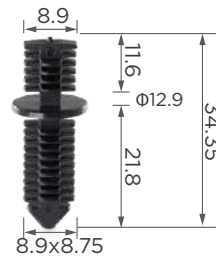

C1246

**Material:** PA  
**Color:** Black  
**Hood insulation, wheelarch fender**

# PUSH TYPE RETAINER

**Product No.:** C0121

**Material:** PA  
**Color:** Black  
**Position:** Expanding retainer



Product Details

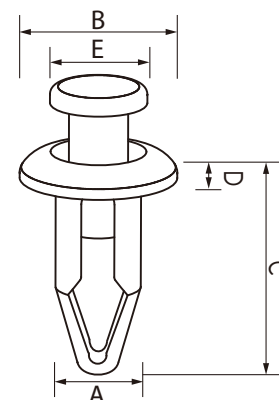

Part No.	Material	Color	in									
			A	B	C	D	E	Φ A	Φ B	C	D	E
C1408	PA	Black	4.95	14.95x10.05	20.20	1.50	10.05	0.193	0.58x0.40	0.788	0.059	0.392
C0705	PA	Black	5.60	14.75	18.65	2.40	9.65	0.218	0.575	0.727	0.094	0.376
C0253	PA	Black	5.75	11.00	13.40	1.50	11.00	0.224	0.429	0.523	0.059	0.429
C1449	PA	Grey	5.75	20.10	16.15	2.20	9.85	0.224	0.784	0.630	0.086	0.384
C1103	PA	Black	5.80	15.00	16.10	2.15	9.70	0.226	0.585	0.628	0.084	0.378
C3383	PA	Black	5.80	15.10	15.20	1.30	9.60	0.226	0.589	0.593	0.051	0.374
C1448	PA	Black	5.80	19.90	16.00	2.20	9.80	0.226	0.776	0.624	0.086	0.382
C0181	PA	Black	6.00	13.50	17.25	1.10	10.10	0.234	0.527	0.673	0.043	0.394
C1733	PA	Black	6.00	15.60	19.50	2.05	15.15	0.234	0.608	0.761	0.080	0.591
C0280	PA	Black	6.10	14.85	30.30	1.95	19.00	0.238	0.579	1.182	0.076	0.741
C0574	PA	Black	6.10	13.60	17.40	1.20	14.10	0.238	0.530	0.679	0.047	0.550
C0508	PA	Black	6.20	15.15	25.50	2.45	9.80	0.242	0.591	0.995	0.096	0.382
C0956	PA	Black	6.20	18.35	28.10	3.00	9.80	0.242	0.716	1.096	0.117	0.382
C0507	PA	Black	6.30	17.60	20.90	2.50	9.80	0.246	0.686	0.815	0.098	0.382
C0681	PA	Black	6.35	25.20	25.55	3.35	9.90	0.248	0.983	0.996	0.131	0.386
C0542	PA	Black	6.40	11.60	15.15	1.30	14.30	0.250	0.452	0.591	0.051	0.558
C1774	PA	Black	6.40	17.50	25.80	3.05	9.70	0.250	0.683	1.006	0.119	0.378
C0240	PA	Black	6.50	10.90	21.80	1.50	7.00	0.254	0.425	0.850	0.059	0.273
C0046	PA	Black	6.50	17.40	25.20	3.00	9.50	0.254	0.679	0.983	0.117	0.371
C0047	PA	Black	6.50	17.95	25.30	2.30	10.30	0.254	0.700	0.987	0.090	0.402
C0509	PA	Black	6.50	25.40	26.60	3.30	9.70	0.254	0.991	1.037	0.129	0.378
C0193	PA	Black	6.55	17.25	22.20	1.85	8.90	0.255	0.673	0.866	0.072	0.347
C0659	PA	Black	6.55	17.25	19.10	2.50	13.25	0.255	0.673	0.745	0.098	0.517
C0510	PA	Black	6.60	12.55	33.40	2.80	9.75	0.257	0.489	1.303	0.109	0.380
C0334	PA	Black	6.70	11.80	19.70	2.60	6.85	0.261	0.460	0.768	0.101	0.267
C1864	PA	Black	6.70	16.15	16.10	1.80	15.90	0.261	0.630	0.628	0.070	0.620
C0195	PA	Black	6.80	18.85	30.55	1.80	18.00	0.265	0.735	1.191	0.070	0.702
C0506	PA	Black	6.80	11.15	19.40	1.60	10.90	0.265	0.435	0.757	0.062	0.425
C0584	PA	Black	6.80	18.80	29.70	3.50	10.60	0.265	0.733	1.158	0.137	0.413

## PUSH TYPE RETAINER

Part No.	Material	Color						in				
			A	B	C	D	E	Φ A	Φ B	C	D	E
C3474	PA	Black	7.00	12.70	33.80	3.00	10.00	0.273	0.495	1.318	0.117	0.390
C0615	PA	Black	7.00	17.75	30.50	2.80	9.90	0.273	0.692	1.190	0.109	0.386
C0473	PA	Black	7.00	18.00	25.15	2.40	14.10	0.273	0.702	0.981	0.094	0.550
C0602	PA	Grey	7.00	25.60	30.50	2.00	24.40	0.273	0.998	1.190	0.078	0.952
C0672	PA	Black	7.10	14.90	21.60	2.60	11.00	0.277	0.581	0.842	0.101	0.429
C0188	PA	Black	7.20	16.70	19.85	2.00	6.40	0.281	0.651	0.774	0.078	0.250
C0532	PA	Black	7.20	25.20	28.50	2.35	10.05	0.281	0.983	1.112	0.092	0.392
C0559	PA	Black	7.30	15.10	24.80	1.90	10.00	0.285	0.589	0.967	0.074	0.390
C0614	PA	Black	7.30	17.50	21.55	2.55	10.00	0.285	0.683	0.840	0.099	0.390
C0043	PA	Black	7.30	17.60	24.80	1.90	10.05	0.285	0.686	0.967	0.074	0.392
C0533	PA	Black	7.30	25.00	24.50	1.85	9.80	0.285	0.975	0.956	0.072	0.382
C0831	PA	Black	7.40	19.80	19.50	2.70	12.00	0.289	0.772	0.761	0.105	0.468
C1791	PA	Black	7.45	22.0x10.1	15.70	3.80	10.00	0.291	0.85x0.39	0.612	0.148	0.390
C0339	PA	Black	7.50	16.15	23.30	2.15	11.80	0.293	0.630	0.909	0.084	0.460
C1804	PA	Black	7.50	18.00	20.60	2.95	9.85	0.293	0.702	0.803	0.115	0.384
C0475	PA	Black	7.50	25.10	24.70	2.50	10.30	0.293	0.979	0.963	0.098	0.402
C0281	PA	Black	7.65	21.70	23.10	2.55	9.65	0.298	0.846	0.901	0.099	0.376
C1914	PA	Black	7.80	19.70	22.20	2.60	9.90	0.304	0.768	0.866	0.101	0.386
C0338	PA	Black	7.80	19.80	24.60	2.20	9.85	0.304	0.772	0.959	0.086	0.384
C3539	PA	Black	7.84	14.75	27.90	2.70	9.40	0.306	0.575	1.088	0.105	0.367
C0069	PA	Black	7.90	14.85	32.10	3.00	9.80	0.308	0.579	1.252	0.117	0.382
C0512	PA	Black	7.90	14.85	22.85	2.90	9.70	0.308	0.579	0.891	0.113	0.378
C0341	PA	Black	7.90	17.90	20.50	3.00	9.40	0.308	0.698	0.800	0.117	0.367
C0886	PA	Black	7.95	20.00	28.90	2.60	14.60	0.310	0.780	1.127	0.101	0.569
C0109	PA	Black	8.00	19.60	21.50	2.75	9.90	0.312	0.764	0.839	0.107	0.386
C0573	PA	Black	8.00	20.00	23.70	2.50	9.65	0.312	0.780	0.924	0.098	0.376
C0071	PA	Black	8.00	20.20	29.10	1.45	19.90	0.312	0.788	1.135	0.057	0.776
C0474	PA	Black	8.10	25.30	25.35	2.60	10.10	0.316	0.987	0.989	0.101	0.394
C0321	PA	Black	8.15	19.80	23.20	2.70	9.45	0.318	0.772	0.905	0.105	0.369
C0645	PA	Black	8.20	18.30	26.35	3.25	15.90	0.320	0.714	1.028	0.127	0.620
C0605	PA	Grey	8.30	25.35	26.30	2.05	10.10	0.324	0.989	1.026	0.080	0.394
C0121	PA	Black	8.35	15.70	22.95	2.70	9.60	0.326	0.612	0.895	0.105	0.374
C0465	PA	Black	8.50	25.60	25.15	2.05	10.30	0.332	0.998	0.981	0.080	0.402
C3479	PA	Black	8.50	20.00	24.00	3.75	14.60	0.332	0.780	0.936	0.146	0.569
C0569	PA	Black	8.55	15.00	23.25	2.50	10.90	0.333	0.585	0.907	0.098	0.425
C3176	PA	Black	8.60	24.80	21.10	2.00	17.50	0.335	0.967	0.823	0.078	0.683
C1272	PA	Black	8.65	17.90	22.65	2.50	10.00	0.337	0.698	0.883	0.098	0.390
C0632	PA	Black	8.70	14.60	30.00	3.10	9.95	0.339	0.569	1.170	0.121	0.388
C0657	PA	Black	8.80	17.25	22.00	1.00	20.15	0.343	0.673	0.858	0.039	0.786
C1178	PA	Black	8.80	17.70	34.50	3.10	13.90	0.343	0.690	1.346	0.121	0.542
C3624	POM	Black	8.80	32.80	32.50	3.05	13.90	0.343	1.279	1.268	0.119	0.542
C0611	PA	Black	8.85	18.00	30.60	3.00	13.90	0.345	0.702	1.193	0.117	0.542
C0110	PA	Black	8.90	18.00	26.40	1.90	9.80	0.347	0.702	1.030	0.074	0.382

## PUSH TYPE RETAINER

Part No.	Material	Color						in				
			A	B	C	D	E	Φ A	Φ B	C	D	E
C0666	PA	Black	8.90	20.10	30.50	3.15	12.80	0.347	0.784	1.190	0.123	0.499
C3096	POM	Black	9.00	17.70	31.30	3.00	18.90	0.351	0.690	1.221	0.117	0.737
C1887	PA	Black	9.00	17.90	18.80	0.90	17.80	0.351	0.698	0.733	0.035	0.694
C3591	PA	Black	9.00	17.90	22.60	2.50	16.10	0.351	0.698	0.881	0.098	0.628
C3864	PA	Black	9.00	14.75	28.40	3.00	9.65	0.351	0.575	1.108	0.117	0.376
C0111	PA	Black	9.05	14.70	29.70	3.00	9.80	0.353	0.573	1.158	0.117	0.382
C1511	PA	Black	9.05	17.85	20.10	2.55	16.00	0.353	0.696	0.784	0.099	0.624
C1510	PA	Black	9.40	17.95	24.85	2.50	16.00	0.367	0.700	0.969	0.098	0.624
C0568	PA	Black/ Grey /Grey yellow	9.50	19.90	24.50	2.65	15.20	0.371	0.776	0.956	0.103	0.593
C0116	PA	Black	10.00	19.80	25.40	2.70	10.40	0.390	0.772	0.991	0.105	0.406
C3839	PA	Black	10.10	18.00	18.25	2.00	12.10	0.394	0.702	0.712	0.078	0.472
C3367	PA	Black	10.25	18.95	18.70	2.55	15.95	0.400	0.739	0.729	0.099	0.622
C0160	PA	Black	10.30	25.65	29.80	2.45	9.95	0.402	1.000	1.162	0.096	0.388
C0159	PA	Black	10.35	25.10	27.80	2.40	9.90	0.404	0.979	1.084	0.094	0.386
C0544	PA	Black	10.40	21.30	28.70	2.80	9.80	0.406	0.831	1.119	0.109	0.382
C0594	PA	Grey	10.40	25.65	48.25	2.60	10.20	0.406	1.000	1.882	0.101	0.398
C0168	PA	Black	10.50	17.90	25.45	2.50	10.00	0.410	0.698	0.993	0.098	0.390
C3583	PA	Black	10.50	19.00	18.60	2.50	16.00	0.410	0.741	0.725	0.098	0.624
C1147	PA	Black	10.50	19.10	16.60	2.65	16.00	0.410	0.745	0.647	0.103	0.624
C0513	PA	Black	10.50	21.40	29.20	3.25	9.70	0.410	0.835	1.139	0.127	0.378
C0598	PA	Grey	10.50	25.50	43.30	2.60	10.15	0.410	0.995	1.689	0.101	0.396
C1948	PA	Black	10.55	17.85	28.30	2.50	10.00	0.411	0.696	1.104	0.098	0.390
C0039	PA	Black	10.65	22.00	28.65	2.50	10.00	0.415	0.858	1.117	0.098	0.390
C1313	PA	Black	10.85	17.70	28.65	2.50	9.80	0.423	0.690	1.117	0.098	0.382
C0115	PA	Black	10.90	19.90	30.90	2.50	10.30	0.425	0.776	1.205	0.098	0.402
C0117	PA	Black	10.95	25.10	31.15	2.35	10.40	0.427	0.979	1.215	0.092	0.406
C0192	PA	Black	10.95	45.3x22.25	31.80	2.40	10.05	0.427	1.767x0.87	1.240	0.094	0.392
C1687	PA	Black	11.10	19.95	22.70	2.65	15.75	0.433	0.778	0.885	0.103	0.614
C3342	PA	Black	11.10	20.00	26.80	2.50	16.10	0.433	0.780	1.045	0.098	0.628
C1337	PA	Black	11.15	20.25	2.65	2.70	16.00	0.435	0.790	0.103	0.105	0.624
C1769	PA	Black	11.15	20.00	24.10	2.50	16.00	0.435	0.780	0.940	0.098	0.624
C1731	PA	Black	12.00	17.90	21.60	1.60	14.50	0.468	0.698	0.842	0.062	0.566
C0655	PA	Black	12.50	30.30	29.50	5.50	18.20	0.488	1.182	1.151	0.215	0.710
C0576	PA	Black	12.80	29.80	52.75	2.45	10.00	0.499	1.162	2.057	0.096	0.390
C1663	PA	Light green	12.85	23.55	43.30	7.30	16.00	0.501	0.918	1.689	0.285	0.624
C3363	PA	Black	12.85	24.80	22.55	2.40	19.15	0.501	0.967	0.879	0.094	0.747
C3368	PA	Black	12.85	24.90	25.50	2.45	19.00	0.501	0.971	0.995	0.096	0.741
C1772	PA	Black	14.10	19.95	28.90	2.00	13.85	0.550	0.778	1.127	0.078	0.540

# PUSH TYPE RETAINER

**Product No.:** C0088

**Material:** POM  
**Color:** Black  
**Position:** Headlight, wheelarch, fuel pump, fender



Product Details

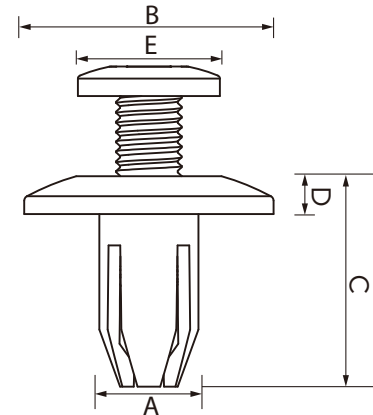

Part No.	Material	Color	mm					in				
			A	B	C	D	E	A	B	C	D	E
C3782	PA	Black	4.00	10.00	9.10	1.00	10.10	0.156	0.390	0.355	0.039	0.394
C3853	PA	Black	4.00	5.75	6.10	1.00	8.00	0.156	0.224	0.238	0.039	0.312
C1750	PA	Black	4.05	5.90	5.00	0.85	7.95	0.158	0.230	0.195	0.033	0.310
C0252	PA	White	4.50	16.45x4.65	7.40	2.15	1.95	0.176	0.636x0.179	0.289	0.084	0.076
C3739	PA	Black	4.60	6.70	14.41	0.95	9.00	0.179	0.261	0.562	0.037	0.351
C1071	PA	Black	4.70	6.40	11.15	1.20	6.30	0.183	0.250	0.435	0.047	0.246
C3967	POM	Black	4.70	7.85	9.40	1.10	2.00	0.183	0.306	0.367	0.043	0.078
C0235	POM	Black	4.80	17.9x6.1	7.50	3.00	2.50	0.187	0.698x0.238	0.293	0.117	0.098
C0560	PA	Black	4.80	11.35	12.70	1.55	13.20	0.187	0.443	0.495	0.060	0.515
C1068	PA	Black	4.80	6.40	9.65	1.50	6.30	0.187	0.250	0.376	0.059	0.246
C1069	PA	Black	4.80	6.40	9.10	1.55	6.45	0.187	0.250	0.355	0.060	0.252
C0152	PA	Black	4.85	7.00	12.45	1.00	9.50	0.189	0.273	0.486	0.039	0.371
C0702	PA	Black	4.85	10.05	15.05	1.75	5.90	0.189	0.392	0.587	0.068	0.230
C3171	POM	Black	4.85	10.00	10.50	2.10	3.80	0.189	0.390	0.410	0.082	0.148
C1418	PA	Black/Dark grey	4.90	11.25	10.15	1.85	6.30	0.191	0.439	0.396	0.072	0.246
C3095	PA	Black	4.90	9.65	11.30	1.80	7.35	0.191	0.376	0.441	0.070	0.287
C1318	PA	Black	5.00	6.50	10.65	1.25	6.60	0.195	0.254	0.415	0.049	0.257
C1979	PA	Black	5.00	10.00	11.80	2.00	6.50	0.195	0.390	0.460	0.078	0.254
C1177	PA	Grey black/Black	5.05	10.10	13.95	2.00	6.30	0.197	0.394	0.544	0.078	0.246
C1382	PA	Black	5.10	43.9x12.1	8.00	2.35	6.50	0.199	1.716x0.472	0.312	0.092	0.254
C0178	PA	Black	5.30	6.90	11.70	2.00	3.10	0.207	0.269	0.456	0.078	0.121
C0319	PA	Black	5.30	8.55	16.25	1.10	12.60	0.207	0.333	0.634	0.043	0.491
C0251	PA	White	5.35	11.20	14.80	1.85	6.30	0.209	0.437	0.577	0.072	0.246
C1707	PA	Black	5.60	10.00	10.80	1.65	9.90	0.218	0.390	0.421	0.064	0.386
C0018	PA	Black	10.00	20.20	27.60	2.60	13.90	0.390	0.788	1.076	0.101	0.542
C3326	POM	Black	5.70	11.80	6.80	1.50	2.95	0.222	0.460	0.265	0.059	0.115
C0374	PA	Black	5.75	11.30	11.10	1.70	3.30	0.224	0.441	0.433	0.066	0.129
C0957	PA	Black	5.80	9.90	12.20	1.50	4.90	0.226	0.386	0.476	0.059	0.191
C1945	POM	Black	5.80	13.90	11.40	1.55	13.25	0.226	0.542	0.445	0.060	0.517



## PUSH TYPE RETAINER

Part No.	Material	Color	mm					in				
			A	B	C	D	E	A	B	C	D	E
C0833	POM	Black	5.85	16.00	14.25	2.25	9.80	0.228	0.624	0.556	0.088	0.382
C0133	PA	Black	5.90	11.7x7.95	8.60	1.35	4.90	0.230	0.456x0.308	0.335	0.053	0.191
C1757	POM	Black	5.90	14.90	12.82	2.00	10.90	0.230	0.581	0.500	0.078	0.425
C0091	PA	Black	5.95	15.65	15.70	2.20	9.00	0.232	0.610	0.612	0.086	0.351
C1544	PA	Black	5.95	11.30	17.00	2.05	10.00	0.232	0.441	0.663	0.080	0.390
C1951	PA	Black/ White	6.00	9.80	16.80	2.00	3.10	0.234	0.382	0.655	0.078	0.121
C0236	PA	Black	6.00	9.90	8.90	1.80	3.20	0.234	0.386	0.347	0.070	0.125
C0429	PA	Beige	6.00	11.30	9.10	2.00	3.15	0.234	0.441	0.355	0.078	0.123
C0148	PA	Black	6.00	13.50	12.45	2.40	7.80	0.234	0.527	0.486	0.094	0.304
C0135	PA	Black	6.00	15.10	12.75	2.30	8.60	0.234	0.589	0.497	0.090	0.335
C3655	POM	Black	6.00	17.80	14.40	1.60	10.00	0.234	0.694	0.562	0.062	0.390
C0158	PA	Black	6.00	19.50	10.10	2.10	10.25	0.234	0.761	0.394	0.082	0.400
C1445	PA	Black	6.05	14.80	15.15	2.45	9.30	0.236	0.577	0.591	0.096	0.363
C1850	PA	Black	6.05	15.00	13.35	1.65	12.80	0.236	0.585	0.521	0.064	0.499
C0142	PA	Black	6.10	17.80	12.50	2.25	7.85	0.238	0.694	0.488	0.088	0.306
C3877	PA	Black	6.10	10.95	15.90	10.60	3.45	0.238	0.427	0.620	0.413	0.135
C0169	PA	Black	6.20	18.15x11.8	12.00	2.00	9.10	0.242	0.707x0.460	0.468	0.078	0.355
C0556	PA	Black	6.20	18.00	14.90	2.10	8.00	0.242	0.702	0.581	0.082	0.312
C3626	PA	Black	6.20	15.20	12.75	1.55	13.00	0.242	0.593	0.497	0.060	0.507
C1073	PA	Black	6.30	8.50	10.55	1.80	8.10	0.246	0.332	0.411	0.070	0.316
C1074	PA	Black	6.30	8.50	12.95	1.70	8.10	0.246	0.332	0.505	0.066	0.316
C1075	PA	Black	6.30	8.50	12.90	1.70	7.10	0.246	0.332	0.503	0.066	0.277
C1076	PA	Black	6.30	8.50	12.95	1.80	8.10	0.246	0.332	0.505	0.070	0.316
C1072	PA	Black	6.30	8.55	10.00	1.90	7.10	0.246	0.333	0.390	0.074	0.277
C1534	PA	Black	6.30	8.70	9.70	1.80	3.30	0.246	0.339	0.378	0.070	0.129
C0164	PA	Black	6.30	22.4x14.3	10.35	2.35	7.90	0.246	0.874x0.558	0.404	0.092	0.308
C0234	PA	Black	6.45	18x9.15	8.40	3.10	4.10	0.252	0.702x0.359	0.328	0.121	0.160
C1421	PA	Black	6.60	10.00	13.30	2.00	2.80	0.257	0.390	0.519	0.078	0.109
C0337	PA	Black	6.70	17.70	10.60	3.65	11.75	0.261	0.690	0.413	0.142	0.458
C0899	POM	Black	6.70	19.00	12.30	3.95	10.40	0.261	0.741	0.480	0.154	0.406
C0325	PA	Black	6.75	16.85	16.75	3.15	9.85	0.263	0.657	0.653	0.123	0.384
C0044	PA	Black	6.80	15.00	14.80	2.00	9.70	0.265	0.585	0.577	0.078	0.378
C0072	PA	Black	6.80	15.20	15.95	2.80	7.70	0.265	0.593	0.622	0.109	0.300
C1996	PA	Black	6.80	16.10	11.50	1.00	15.00	0.265	0.628	0.449	0.039	0.585
C0273	PA	Black	6.80	17.45	18.60	2.75	8.00	0.265	0.681	0.725	0.107	0.312
C0835	POM	Black	6.80	18.95	11.10	3.40	5.20	0.265	0.739	0.433	0.133	0.203
C3619	POM	Black	6.80	19.05	22.00	5.55	14.10	0.265	0.743	0.858	0.216	0.550
C1851	PA	Black	6.80	19.10	13.45	4.30	10.45	0.265	0.745	0.525	0.168	0.408
C1934	POM	Black	6.80	19.70	13.85	3.40	13.40	0.265	0.768	0.540	0.133	0.523
C1224	POM	Black	6.80	19.80	12.00	3.15	13.80	0.265	0.772	0.468	0.123	0.538
C1399	PA	Black	6.80	20.00	13.20	3.21	14.70	0.265	0.780	0.515	0.125	0.573
C1721	PA	Black	6.80	20.00	14.00	1.90	10.00	0.265	0.780	0.546	0.074	0.390
C1918	POM	Black	6.80	20.00	16.70	3.80	13.05	0.265	0.780	0.651	0.148	0.509

## PUSH TYPE RETAINER

Part No.	Material	Color	mm					in				
			A	B	C	D	E	A	B	C	D	E
C3643	PA	Black	6.80	23.30	16.30	3.40	9.70	0.265	0.909	0.636	0.133	0.378
C1430	POM	Black	6.80	18.4x18.4	15.45	4.20	13.60	0.265	0.718x0.055	0.603	0.164	0.530
C1324	POM	Black	6.85	15.50	21.90	11.00	11.75	0.267	0.605	0.854	0.429	0.458
C1359	POM	Black	6.85	20.00	11.40	2.50	14.00	0.267	0.780	0.445	0.098	0.546
C3585	PA	Black	6.85	17.95	13.60	2.00	9.65	0.267	0.700	0.530	0.078	0.376
C0618	PA	Black/ Grey	6.90	15.30	10.70	1.05	15.30	0.269	0.597	0.417	0.041	0.597
C1886	PA	Black	6.90	15.95	13.20	2.20	2.95	0.269	0.622	0.515	0.086	0.115
C0538	PA	Black	6.90	18.20	20.30	2.55	7.7x7.85	0.269	0.710	0.792	0.099	0.300
C3172	POM	Grey	6.90	19.90	17.60	2.65	13.05	0.269	0.776	0.686	0.103	0.509
C1525	POM	Black	6.90	20.25	16.70	2.36	14.30	0.269	0.790	0.651	0.092	0.558
C0999	POM	Black	6.90	20.50	13.60	2.90	14.00	0.269	0.800	0.530	0.113	0.546
C0893	POM	Black	6.90	20.60	13.60	2.90	14.00	0.269	0.803	0.530	0.113	0.546
C0934	PA	White	6.95	18.25x12.6	11.30	5.15	5.10	0.271	0.710x0.491	0.441	0.201	0.199
C1343	POM	Black	6.95	20.15	11.20	2.80	13.10	0.271	0.786	0.437	0.109	0.511
C1722	POM	Black	6.95	20.00	14.10	2.60	13.00	0.271	0.780	0.550	0.101	0.507
C1622	PA	Black	7.00	14.05	14.20	1.70	9.95	0.273	0.548	0.554	0.066	0.388
C0700	PA	Black	7.00	17.50	13.10	3.10	9.60	0.273	0.683	0.511	0.121	0.374
C0837	POM	Black	7.00	18.10	10.90	3.40	12.15	0.273	0.706	0.425	0.133	0.474
C0395	PA	Black	7.10	17.40	12.70	3.00	9.80	0.277	0.679	0.495	0.117	0.382
C0092	PA	Black	7.15	20.00	11.30	2.60	9.90	0.279	0.780	0.441	0.101	0.386
C0063	POM	Black	7.20	20.05	14.40	3.10	12.70	0.281	0.782	0.562	0.121	0.495
C3634	POM	Natural	7.20	19.8x12.25	8.70	1.40	3.95	0.281	0.772x0.478	0.339	0.055	0.154
C0156	PA	Black	7.25	12.3x12.3	19.70	3.15	8.15	0.283	0.480x0.0480	0.768	0.123	0.318
C0175	PA	Black	7.30	14.00	14.20	1.60	9.90	0.285	0.546	0.554	0.062	0.386
C0216	PA	Black	7.30	16.30	16.70	2.50	3.50	0.285	0.636	0.651	0.098	0.137
C3328	PA	Black	7.30	20.00	19.85	1.50	12.00	0.285	0.780	0.774	0.059	0.468
C1611	PA	Black	7.35	21.75	14.75	2.80	5.40	0.287	0.848	0.575	0.109	0.211
C0880	PA	Black/ Dark grey	7.50	16.00	19.20	1.40	7.95	0.293	0.624	0.749	0.055	0.310
C3194	POM	Black	7.50	22.25	11.50	2.15	5.60	0.293	0.868	0.449	0.084	0.218
C1532	PA	Black	7.60	9.75	14.00	1.90	3.95	0.296	0.380	0.546	0.074	0.154
C0426	PA	Black	7.70	18.30	19.80	2.00	4.70	0.300	0.714	0.772	0.078	0.183
C0623	PA	Black	7.70	19.75	13.60	3.50	13.70	0.300	0.770	0.530	0.137	0.534
C1735	PA	Black	7.70	10.00	14.00	2.10	3.45	0.300	0.390	0.546	0.082	0.135
C3320	POM	Black	7.70	19.90	13.10	2.25	12.10	0.300	0.776	0.511	0.088	0.472
C3372	PA	Black	7.70	20.55	22.15	1.30	15.00	0.300	0.801	0.864	0.051	0.585
C1692	POM	Black	7.75	20.00	14.84	2.84	12.85	0.302	0.780	0.579	0.111	0.501
C3066	PA	Brown	7.75	21.80	26.95	2.10	8.60	0.302	0.850	1.051	0.082	0.335
C1080	PA	Black	7.80	10.60	11.30	2.10	9.50	0.304	0.413	0.441	0.082	0.371
C1081	PA	Black	7.80	10.60	13.30	2.30	15.80	0.304	0.413	0.519	0.090	0.616
C1082	PA	Black	7.80	10.60	14.45	2.20	7.50	0.304	0.413	0.564	0.086	0.293
C1083	PA	Black	7.80	10.60	13.40	2.30	9.50	0.304	0.413	0.523	0.090	0.371
C1452	PA	Black	7.80	19.75	9.30	2.40	10.00	0.304	0.770	0.363	0.094	0.390
C1453	PA	Black	7.80	16.65	15.30	2.50	10.40	0.304	0.649	0.597	0.098	0.406

## PUSH TYPE RETAINER

Part No.	Material	Color	mm					in				
			A	B	C	D	E	A	B	C	D	E
C1660	PA	Black	7.80	12.60	14.40	2.00	5.45	0.304	0.491	0.562	0.078	0.213
C1876	POM	Black	7.80	20.00	13.15	2.80	14.60	0.304	0.780	0.513	0.109	0.569
C3277	PA	Black	7.80	20.00	15.85	3.75	13.80	0.304	0.780	0.618	0.146	0.538
C0122	PA	Black	7.85	17.80	24.60	2.65	12.80	0.306	0.694	0.959	0.103	0.499
C0248	PA	Black	7.85	10.70	11.50	2.10	7.65	0.306	0.417	0.449	0.082	0.298
C1084	PA	Black	7.85	10.60	14.40	2.05	15.80	0.306	0.413	0.562	0.080	0.616
C1713	POM	Black	7.85	17.90	13.30	3.40	11.00	0.306	0.698	0.519	0.133	0.429
C0083	PA	Black	7.90	20.10	13.30	3.00	14.85	0.308	0.784	0.519	0.117	0.579
C0425	PA	Black	7.90	17.40	13.90	3.10	6.50	0.308	0.679	0.542	0.121	0.254
C0578	PA	Black	7.90	18.00	15.20	2.20	10.70	0.308	0.702	0.593	0.086	0.417
C0869	POM	Black/ Black grey/ Grey	7.90	19.65	13.90	2.40	6.55	0.308	0.766	0.542	0.094	0.255
C1077	PA	Black	7.90	10.60	10.65	2.25	15.80	0.308	0.413	0.415	0.088	0.616
C1078	PA	Black	7.90	10.65	10.60	2.35	7.55	0.308	0.415	0.413	0.092	0.294
C1079	PA	Black	7.90	10.65	10.65	1.90	9.50	0.308	0.415	0.415	0.074	0.371
C1507	POM	Black	7.90	20.00	11.90	1.95	19.25	0.308	0.780	0.464	0.076	0.751
C1704	POM	Black	7.90	20.05	13.50	3.00	14.80	0.308	0.782	0.527	0.117	0.577
C1729	POM	Black	7.90	18.00	15.55	1.55	15.40	0.308	0.702	0.606	0.060	0.601
C1981	POM	Black	7.90	20.10	15.70	2.00	15.55x13.1	0.308	0.784	0.612	0.078	0.608x0.511
C1553	PA	Black	7.95	19.85	13.40	3.00	7.80	0.310	0.774	0.523	0.117	0.304
C1765	PA	Black	7.95	20.20	14.20	4.00	13.70	0.310	0.788	0.554	0.156	0.534
C1766	PA	Black	7.95	17.60	14.90	2.55	10.50	0.310	0.686	0.581	0.099	0.410
C3804	POM	Black	7.95	20.00	15.00	4.85	14.80	0.310	0.780	0.585	0.189	0.577
C0070	PA	Black	8.00	22.00	16.50	3.00	13.80	0.312	0.858	0.644	0.117	0.538
C0080	PA	Black	8.00	19.90	28.80	2.90	9.65	0.312	0.776	1.123	0.113	0.376
C0123	PA	Black	8.00	20.00	17.65	2.50	13.80	0.312	0.780	0.688	0.098	0.538
C1933	POM	Black	8.00	19.90	15.70	2.90	11.30	0.312	0.776	0.612	0.113	0.441
C0701	PA	Black	8.05	14.95	15.60	2.05	9.50	0.314	0.583	0.608	0.080	0.371
C1444	PA	Black	8.05	13.15	15.85	2.05	9.00	0.314	0.513	0.618	0.080	0.351
C0938	PA	Gery	8.10	18.10	19.30	2.45	4.00	0.316	0.706	0.753	0.096	0.156
C0221	PA	Black	8.10	19.80	15.85	2.80	9.50	0.316	0.772	0.618	0.109	0.371
C0081	PA	Black	8.10	20.30	23.50	3.00	9.60	0.316	0.792	0.917	0.117	0.374
C0045	PA	Black	8.20	20.30	11.70	2.70	9.70	0.320	0.792	0.456	0.105	0.378
C0128	PA	Black	8.20	20.00	11.80	3.00	12.30	0.320	0.780	0.460	0.117	0.480
C1542	PA	Black	8.20	17.75	15.30	2.70	10.65	0.320	0.692	0.597	0.105	0.415
C0173	PA	Grey	8.30	31.90	14.20	3.00	3.95	0.324	1.244	0.554	0.117	0.154
C0176	PA	Black	8.30	15.80	13.90	3.30	4.00	0.324	0.616	0.542	0.129	0.156
C0677	PA	Black	8.40	17.90	21.00	3.20	9.50	0.328	0.698	0.819	0.125	0.371
C1736	POM	Black	8.50	14.90	12.30	1.60	9.1x7.95	0.332	0.581	0.480	0.062	0.355x0.311
C0141	PA	Black	8.60	19.60	23.90	2.95	10.30	0.335	0.764	0.932	0.115	0.402
C1488	POM	Natural	8.60	27.95x21.0	13.45	6.40	4.85	0.335	1.092x0.819	0.525	0.250	0.189
C3182	PA	Light green	8.60	16.00	16.70	2.40	4.15	0.335	0.624	0.651	0.094	0.162
C3741	PA	Black	8.60	12.30	13.85	1.95	4.75	0.335	0.480	0.540	0.076	0.185
C3241	PA	Light green	8.70	18.35	11.45	1.90	4.15	0.339	0.716	0.447	0.074	0.162

## PUSH TYPE RETAINER

Part No.	Material	Color	mm					in				
			A	B	C	D	E	A	B	C	D	E
C0883	PA	Black	8.80	12.70	17.60	3.00	4.00	0.343	0.495	0.686	0.117	0.156
C0998	POM	Black	8.85	17.80	12.10	2.40	12.80	0.345	0.694	0.472	0.094	0.499
C1225	POM	Black	8.85	21.95	18.30	3.20	15.00	0.345	0.856	0.714	0.125	0.585
C1760	PA	Black	8.90	20.00	16.00	2.00	14.90	0.347	0.780	0.624	0.078	0.581
C0641	POM	Black	9.00	17.90	15.50	3.00	7.00	0.351	0.698	0.605	0.117	0.273
C0803	POM	Black	9.00	19.90	11.75	2.60	11.90	0.351	0.776	0.458	0.101	0.464
C0947	PA	Gery	9.20	12.25	12.10	1.10	5.00	0.359	0.478	0.472	0.043	0.195
C1954	PA	Dark grey	9.20	12.00	12.00	1.60	12.00	0.359	0.468	0.468	0.062	0.468
C0678	PA	Black	9.25	16.00	16.20	2.30	4.75	0.361	0.624	0.632	0.090	0.185
C1150	PA	Black	9.25	15.90	13.95	2.00	4.90	0.361	0.620	0.544	0.078	0.191
C3071	PA	Black	9.25	14.80	12.60	1.80	8.10	0.361	0.577	0.491	0.070	0.316
C3312	PA	Black	9.30	16.10	14.85	2.00	5.00	0.363	0.628	0.579	0.078	0.195
C3909	PA	Black	9.40	15.35	18.50	1.60	13.00	0.367	0.599	0.722	0.062	0.507
C3261	PA	Grey/ Black	9.40	15.50	15.00	2.00	17.05	0.367	0.605	0.585	0.078	0.665
C1580	PA	Black	9.42	19.70	11.00	1.60	14.80	0.367	0.768	0.429	0.062	0.577
C1285	PA	Black	9.45	15.90	12.50	2.00	5.00	0.369	0.620	0.488	0.078	0.195
C0846	PA	Black	9.50	13.80	12.10	1.10	14.00	0.371	0.538	0.472	0.043	0.546
C1764	PA	Black	9.50	19.00	17.80	2.60	4.98	0.371	0.741	0.694	0.101	0.194
C1582	PA	Black	9.60	22.20	15.80	2.90	4.50	0.374	0.866	0.616	0.113	0.176
C1745	PA	Black	9.60	12.90	13.25	1.15	18.85	0.374	0.503	0.517	0.045	0.735
C3620	POM	Black	9.65	19.80	15.70	3.45	13.85	0.376	0.772	0.612	0.135	0.540
C1518	POM	Black	9.75	19.90	17.45	3.40	13.85	0.380	0.776	0.681	0.133	0.540
C1873	POM	Black	9.75	19.95	23.55	2.55	13.70	0.380	0.778	0.918	0.099	0.534
C0570	PA	Black	9.80	20.10	16.10	2.30	14.00	0.382	0.784	0.628	0.090	0.546
C1107	POM	Black	9.80	20.15	16.90	2.85	14.00	0.382	0.786	0.659	0.111	0.546
C3825	POM	Black	9.90	20.00	25.00	3.00	14.5X17.0	0.386	0.780	0.975	0.117	0.566X0.663
C3206	PA	Black	10.00	12.19	14.10	2.10	17.30	0.390	0.475	0.550	0.082	0.675
C0283	POM	Black	10.00	19.50	17.65	2.40	13.90	0.390	0.761	0.688	0.094	0.542
C1509	POM	Black	10.00	19.90	20.00	3.55	13.30	0.390	0.776	0.780	0.138	0.519
C3664	POM	Black	10.00	29.90	15.00	3.00	17.9x16.0	0.390	1.166	0.585	0.117	0.698x0.624
C1822	POM	Black	10.20	30.50	18.00	2.20	13.90	0.398	1.190	0.702	0.086	0.542
C1874	PA	Black	10.50	15.80	13.85	2.05	6.80	0.410	0.616	0.540	0.080	0.265
C1720	POM	Black	10.65	25.00	18.55	3.10	17.50	0.415	0.975	0.723	0.121	0.683
C3191	PA	Black	11.85	17.80	14.50	3.00	13.40	0.462	0.694	0.566	0.117	0.523
C3570	PA	Light green	11.90	20.00	18.00	5.10	12.70	0.464	0.780	0.702	0.199	0.495
C1940	PA	Black	21.95	28.80	14.70	3.80	24.00	0.856	1.123	0.573	0.148	0.936
C1849	POM	Black	22.00	37.70	36.10	3.70	25.00	0.858	1.470	1.408	0.144	0.975

# PUSH TYPE RETAINER

**Product No.: C0088**

**Material:** POM  
**Color:** Black  
**Position:** Headlight, wheelarch, fuel pump, fender



Product Details

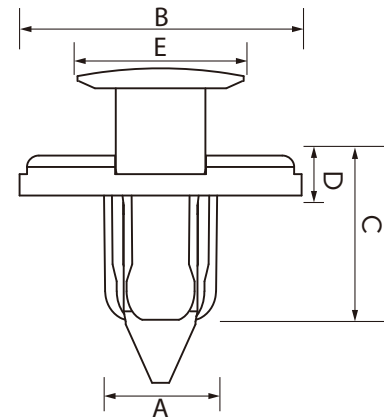

Part No.	Material	Color	mm					in				
			A	B	C	D	E	A	B	C	D	E
C3549	POM	Black	5.00	11.40	8.70	0.95	14.00	0.195	0.445	0.339	0.037	0.546
C0991	POM	Black	5.35	12.70	15.10	2.55	9.00	0.209	0.495	0.589	0.099	0.351
C1547	POM	Black	5.90	17.85	15.55	1.45	9.95	0.230	0.696	0.606	0.057	0.388
C0085	POM	Black/ Grey	6.00	1.55	9.90	1.65	4.60	0.234	0.060	0.386	0.064	0.179
C0376	POM	Black	6.00	14.30	11.25	2.00	9.70	0.234	0.558	0.439	0.078	0.378
C0997	POM	Black	6.00	14.05	11.30	2.00	10.00	0.234	0.548	0.441	0.078	0.390
C3493	PA	Dark grey	6.05	12.00	15.20	1.60	4.25	0.236	0.468	0.593	0.062	0.166
C0084	POM	Black/White /Grey black/ Yellow grey	6.70	10.85	16.10	1.50	5.40	0.261	0.423	0.628	0.059	0.211
C0274	POM	Grey/ Black	6.10	14.15	11.10	2.00	9.90	0.238	0.552	0.433	0.078	0.386
C0824	POM	Black	6.10	18.00	10.10	2.30	9.80	0.238	0.702	0.394	0.090	0.382
C3410	POM	Black	6.10	12.10	13.15	2.80	10.10	0.238	0.472	0.513	0.109	0.394
C0959	POM	Black	6.50	11.10	11.40	1.40	5.30	0.254	0.433	0.445	0.055	0.207
C3504	POM	Dark grey	6.50	17.80	11.55	1.45	5.40	0.254	0.694	0.450	0.057	0.211
C3902	POM	Black	6.50	15.00	12.00	1.50	5.50	0.254	0.585	0.468	0.059	0.215
C1153	POM	Black	6.60	15.00	10.07	1.59	5.50	0.257	0.585	0.393	0.062	0.215
C1420	POM	Black	6.60	15.05	10.40	1.85	5.30	0.257	0.587	0.406	0.072	0.207
C0189	POM	Black/Light grey/Dark brown/Dark gery	6.70	17.90	13.30	1.70	5.50	0.261	0.698	0.519	0.066	0.215
C1805	PA	Black	6.75	17.80	13.85	1.65	16.50	0.263	0.694	0.540	0.064	0.644
C0333	POM	Black	6.80	15.90	13.65	1.70	5.30	0.265	0.620	0.532	0.066	0.207
C0390	POM	Black/ Grey	6.80	15.90	10.30	2.25	9.90	0.265	0.620	0.402	0.088	0.386
C0564	POM	Black	6.80	14.95	10.15	1.50	5.30	0.265	0.583	0.396	0.059	0.207
C1329	POM	Black	6.85	15.80	17.80	3.05	10.85	0.267	0.616	0.694	0.119	0.423
C0090	POM	Black	6.90	20.35	10.30	2.50	13.85	0.269	0.794	0.402	0.098	0.540
C0276	POM	Grey	6.90	20.10	11.00	2.60	12.85	0.269	0.784	0.429	0.101	0.501
C1714	POM	Black	6.90	15.40	9.85	2.20	9.75	0.269	0.601	0.384	0.086	0.380
C0801	POM	Black	6.95	11.40	16.55	3.70	17.50	0.271	0.445	0.645	0.144	0.683
C0566	POM	Black	7.00	13.70	14.40	3.90	17.25	0.273	0.534	0.562	0.152	0.673



## PUSH TYPE RETAINER

Part No.	Material	Color	mm					in				
			A	B	C	D	E	A	B	C	D	E
C1419	POM	Black	7.00	20.00	11.55	2.65	11.80	0.273	0.780	0.450	0.103	0.460
C0097	POM	Black	7.10	16.60	10.00	1.80	5.15	0.277	0.647	0.390	0.070	0.201
C0215	POM	Black	7.30	15.80	12.00	2.95	9.80	0.285	0.616	0.468	0.115	0.382
C0107	POM	Black	7.50	13.65	12.75	4.10	17.50	0.293	0.532	0.497	0.160	0.683
C0633	POM	Black/ Grey	7.75	17.10	14.15	2.10	4.70	0.302	0.667	0.552	0.082	0.183
C1526	POM	Black	7.75	19.90	9.40	2.15	12.7X9.0	0.302	0.776	0.367	0.084	0.495x0.351
C1739	POM	Black	7.75	18.00	12.60	2.60	12.80	0.302	0.702	0.491	0.101	0.499
C0118	POM	Black	7.80	19.40	13.70	2.10	6.10	0.304	0.757	0.534	0.082	0.238
C3170	POM	Black	7.80	19.90	11.00	2.65	6.70	0.304	0.776	0.429	0.103	0.261
C3651	POM	Black	7.80	16.05	12.20	2.60	12.85	0.304	0.626	0.476	0.101	0.501
C3043	PA	Black	7.90	17.95	12.50	2.50	10.75	0.308	0.700	0.488	0.098	0.419
C3366	POM	Black	7.90	17.95	11.40	1.30	15.80	0.308	0.700	0.445	0.051	0.616
C0351	POM	Black	7.90	18.00	12.30	2.50	13.70	0.308	0.702	0.480	0.098	0.534
C0636	PA	Black	7.90	19.90	12.20	3.00	13.00	0.308	0.776	0.476	0.117	0.507
C3457	POM	Black	7.90	19.90	13.50	2.60	6.80	0.308	0.776	0.527	0.101	0.265
C0888	POM	Black	7.93	19.90	16.10	3.50	12.90	0.309	0.776	0.628	0.137	0.503
C0541	POM	Black	7.95	19.45	10.75	2.35	6.90	0.310	0.759	0.419	0.092	0.269
C1723	POM	Black	7.95	20.05	10.10	2.90	18.9x15.85	0.310	0.782	0.394	0.113	0.737x0.620
C3055	POM	Black	7.95	18.00	13.30	1.50	16.70	0.310	0.702	0.519	0.059	0.651
C0088	POM	Black	8.00	20.20	11.45	2.80	11.90	0.312	0.788	0.447	0.109	0.464
C0649	POM	Black	8.00	17.80	18.15	3.00	12.70	0.312	0.694	0.708	0.117	0.495
C3345	POM	Black	8.10	19.80	10.70	1.70	15.75	0.316	0.772	0.417	0.066	0.614
C1549	POM	Black	8.20	17.70	14.60	2.75	10.15	0.320	0.690	0.569	0.107	0.396
C0882	POM	Black	8.40	17.90	14.40	2.10	14.90	0.328	0.698	0.562	0.082	0.581
C0653	POM	Black	8.50	13.70	17.00	4.20	17.40	0.332	0.534	0.663	0.164	0.679
C1316	PA	Black	8.55	22.10	12.00	1.65	6.70	0.333	0.862	0.468	0.064	0.261
C0680	POM	Black	8.75	17.80	15.70	2.95	13.60	0.341	0.694	0.612	0.115	0.530
C1684	POM	Black	8.75	24.45	15.20	1.60	23.20	0.341	0.954	0.593	0.062	0.905
C0684	PA	Gery	8.90	19.15	21.70	1.70	7.30	0.347	0.747	0.846	0.066	0.285
C1267	PA	Black	9.00	24.85	14.90	1.75	7.85	0.351	0.969	0.581	0.068	0.306
C1268	PA	Black	9.00	27.00	19.80	1.80	7.80	0.351	1.053	0.772	0.070	0.304
C0686	POM	Black	9.05	17.90	22.45	3.80	13.85	0.353	0.698	0.876	0.148	0.540
C0145	POM	Black/Dark grey	9.10	14.95	15.45	3.80	10.60	0.355	0.583	0.603	0.148	0.413
C0089	POM	Black	9.60	17.90	18.10	3.10	13.50	0.374	0.698	0.706	0.121	0.527
C0136	PA	Black	9.70	29.6x20	19.80	2.00	14.70	0.378	1.154x0.780	0.772	0.078	0.573
C0354	POM	Black	9.70	19.70	20.85	3.70	13.90	0.378	0.768	0.813	0.144	0.542
C0554	PA	Black	9.80	30.3x20.5	23.15	2.00	12.00	0.382	1.182x0.8	0.903	0.078	0.468
C1119	POM	Black	9.80	20.00	19.33	3.40	13.50	0.382	0.780	0.754	0.133	0.527
C0393	PA	Grey	9.85	29.8x20.1	13.80	1.90	15.00	0.384	1.162x0.784	0.538	0.074	0.585
C0955	POM	Black	9.85	19.95	16.85	3.50	13.60	0.384	0.778	0.657	0.137	0.530
C0634	POM	Black	9.90	19.90	16.50	3.60	13.65	0.386	0.776	0.644	0.140	0.532
C1737	POM	Black	9.90	19.70	17.10	3.50	15.00	0.386	0.768	0.667	0.137	0.585
C1718	POM	Black	9.90	21.00	18.40	3.15	13.85	0.386	0.819	0.718	0.123	0.540

## PUSH TYPE RETAINER

Part No.	Material	Color	mm					in				
			A	B	C	D	E	A	B	C	D	E
C1356	POM	Black	9.95	25.80	20.65	3.15	17.80	0.388	1.006	0.805	0.123	0.694
C0283	POM	Black	10.00	19.50	17.65	2.40	13.90	0.390	0.761	0.688	0.094	0.542
C3077	POM	Black	10.00	20.00	14.90	3.05	12.00	0.390	0.780	0.581	0.119	0.468
C3076	POM	Black	12.95	22.00	16.90	2.95	15.00	0.505	0.858	0.659	0.115	0.585
C1564	POM	Black	15.00	21.95	17.80	4.20	16.30	0.585	0.856	0.694	0.164	0.636
C3227	POM	Black	15.80	25.85	11.45	2.60	19.60	0.616	1.008	0.447	0.101	0.764

**Product No.:** C0264

**Material:** PA  
**Color:** Black  
**Position:** Expanding retainer



Product Details

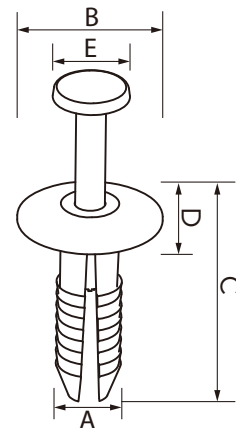

Part No.	Material	Color	mm					in				
			A	B	C	D	E	A	B	C	D	E
C0692	PA	Black	4.60	24.7x8.0	11.60	2.85	3.15	0.179	0.963x0.312	0.452	0.111	0.123
C1395	PA	Black	4.90	8.6x11.9	11.05	2.15	6.30	0.191	0.335x0.468	0.431	0.084	0.246
C0511	PA	White	5.20	10.90	14.00	1.60	11.20	0.203	0.425	0.546	0.062	0.437
C1711	PA	Black	5.80	12.10	10.75	1.60	9.85	0.226	0.472	0.419	0.062	0.384
C3973	PA	Black	6.00	12.25	16.00	1.60	9.80	0.234	0.478	0.624	0.062	0.382
C1422	PP	Black	6.10	17.10	20.70	2.00	21.75	0.238	0.667	0.807	0.078	0.848
C1423	PP	Black	6.10	17.30	20.70	2.00	21.75	0.238	0.675	0.807	0.078	0.848
C0526	PA	Black	6.15	16.00	16.50	2.70	8.90	0.240	0.624	0.644	0.105	0.347
C0894	PA	Black	6.30	18.95	16.10	3.10	8.80	0.246	0.739	0.628	0.121	0.343
C0019	PA	Black	6.40	18.10	18.85	2.80	3.55	0.250	0.706	0.735	0.109	0.138
C1536	PA	Black	6.45	19.70	18.70	1.90	9.90	0.252	0.768	0.729	0.074	0.386
C1852	PA	Black	6.45	14.60	21.90	2.00	7.80	0.252	0.569	0.854	0.078	0.304
C1771	PA	Black	6.50	14.90	17.00	1.95	7.95	0.254	0.581	0.663	0.076	0.310
C3267	PA	Black	6.50	15.00	9.95	1.00	8.00	0.254	0.585	0.388	0.039	0.312
C0264	PA	Black	6.50	15.60	23.20	2.05	8.20	0.254	0.608	0.905	0.080	0.320
C0041	PA	Black	6.50	17.20	16.85	2.50	8.50	0.254	0.671	0.657	0.098	0.332
C0335	PA	Black	6.50	19.30	18.40	2.00	7.65	0.254	0.753	0.718	0.078	0.298
C0144	PA	Black	6.55	14.60	18.75	2.65	3.50	0.255	0.569	0.731	0.103	0.137
C0262	PA	Black	6.55	19.80	17.10	2.00	3.40	0.255	0.772	0.667	0.078	0.133
C1585	PA	Black	6.55	19.80	18.75	2.00	5.90	0.255	0.772	0.731	0.078	0.230
C0595	PA	Black	6.55	21.80	28.50	2.20	21.60	0.255	0.850	1.112	0.086	0.842
C0613	PA	Black	6.60	17.40	15.30	2.40	10.10	0.257	0.679	0.597	0.094	0.394
C1397	PA	Black	6.60	14.90	17.05	2.40	3.50	0.257	0.581	0.665	0.094	0.137

## PUSH TYPE RETAINER

Part No.	Material	Color	mm					in				
			A	B	C	D	E	A	B	C	D	E
C3084	PA	Black	6.70	15.00	17.40	2.30	8.13	0.261	0.585	0.679	0.090	0.317
C1999	PA	Black	6.75	20.10	22.30	2.15	8.05	0.263	0.784	0.870	0.084	0.314
C0597	PA	Black	6.80	17.85	18.70	2.70	8.90	0.265	0.696	0.729	0.105	0.347
C3173	PA	Black	6.80	19.70	17.00	2.00	6.10	0.265	0.768	0.663	0.078	0.238
C3610	POM	Black	6.85	19.80	15.75	3.90	13.15X11.05	0.267	0.772	0.614	0.152	0.513X0.431
C3790	POM	Black	6.90	12.2X14.0	10.60	1.60	7.75	0.269	0.476X0.546	0.413	0.062	0.302
C1597	PP	Dark grey+Black	6.95	18.85	23.00	1.70	26.10	0.271	0.735	0.897	0.066	1.018
C3581	PP	Black	7.00	17.75	30.50	2.80	26.10	0.273	0.692	1.190	0.109	1.018
C3760	PA	Black	7.00	18.80	23.80	1.80	24.30	0.273	0.733	0.928	0.070	0.948
C0373	PA	Black	7.10	15.90	12.00	2.00	4.95	0.277	0.620	0.468	0.078	0.193
C3719	PA	Black	7.10	13.10	15.70	7.00	4.35X4.35	0.277	0.511	0.612	0.273	0.170x0.170
C3658	PA	Brown	7.20	22.00	27.20	2.00	26.00	0.281	0.858	1.061	0.078	1.014
C1581	PA	Black	7.30	15.1x8.2	14.50	1.65	8.00	0.285	0.589x0.320	0.566	0.064	0.312
C3835	POM	Black	7.40	16.60	14.70	2.30	9.10	0.289	0.647	0.573	0.090	0.355
C0530	PA	Black	7.50	16.95	17.00	2.90	8.65	0.293	0.661	0.663	0.113	0.337
C1555	PA	Black	7.50	22.20	15.70	1.75	12.00	0.293	0.866	0.612	0.068	0.468
C1411	PA	Black	7.54	19.70	13.10	1.55	16.00	0.294	0.768	0.511	0.060	0.624
C3636	PA	Black	7.55	15.2X7.1	17.00	3.00	7.95	0.294	0.593X0.277	0.663	0.117	0.310
C1219	PA	Gery	7.60	22.10	22.00	2.00	26.00	0.296	0.862	0.858	0.078	1.014
C1888	PA	Black	7.70	15.95	12.55	1.50	8.60	0.300	0.622	0.489	0.059	0.335
C0214	PA	Black	7.80	17.00	21.20	3.30	8.60	0.304	0.663	0.827	0.129	0.335
C0682	PA	Black	7.80	19.80	10.55	1.60	16.10	0.304	0.772	0.411	0.062	0.628
C1683	PA	Black	7.80	18.50	24.26	4.10	15.90	0.304	0.722	0.946	0.160	0.620
C3696	PA	Black	7.90	19.00	26.74	2.10	23.00	0.308	0.741	1.043	0.082	0.897
C0500	PA	Black+Natural	8.00	15.65	24.65	1.80	25.75	0.312	0.610	0.961	0.070	1.004
C0925	PA	Black	8.00	15.90	16.20	1.30	23.20	0.312	0.620	0.632	0.051	0.905
C3248	PA	Black	8.00	20.10	12.80	1.55	12.05	0.312	0.784	0.499	0.060	0.470
C1806	PA	Black	8.05	17.75	20.80	3.10	9.85	0.314	0.692	0.811	0.121	0.384
C0472	PA	Black	8.10	16.80	16.00	2.09	9.00	0.316	0.655	0.624	0.082	0.351
C0906	PA	Black	8.10	23.90	15.00	1.70	15.90	0.316	0.932	0.585	0.066	0.620
C1425	PP	Black	8.15	17.30	20.50	2.00	21.70	0.318	0.675	0.800	0.078	0.846
C1427	PP	Black	8.15	17.30	20.50	2.00	21.90	0.318	0.675	0.800	0.078	0.854
C0249	PA	Black	8.15	26.1x14	17.75	3.30	8.50	0.318	1.018x0.546	0.692	0.129	0.332
C3207	PA	Black	8.20	34.00	26.60	6.00	15.90	0.320	1.326	1.037	0.234	0.620
C1790	PA	Black	8.25	12.10	14.21	1.56	8.40	0.322	0.472	0.554	0.061	0.328
C3278	PA	White	8.35	20.00	14.40	1.50	19.60	0.326	0.780	0.562	0.059	0.764
C1550	PA	Black	8.40	20.00	16.00	2.90	20.0x8.95	0.328	0.780	0.624	0.113	0.780x0.347
C3188	POM	Black	8.50	24.9x17.9	10.85	1.85	7.90	0.332	0.971x0.698	0.423	0.072	0.308
C3633	PA	Black	8.70	20.15	18.50	2.00	10.95	0.339	0.786	0.722	0.078	0.427
C1533	PA	Black	8.80	20.10	23.70	2.20	15.05	0.343	0.784	0.924	0.086	0.587
C1679	PA	Grey black/ Black	8.85	19.90	11.70	2.30	15.00	0.345	0.776	0.456	0.090	0.585
C1253	PA	Black	8.90	20.30	16.25	2.10	15.20	0.347	0.792	0.634	0.082	0.593
C3565	PA	Black	9.00	32.00	26.40	9.00	29.60	0.351	1.248	1.030	0.351	1.154

## PUSH TYPE RETAINER

Part No.	Material	Color	mm					in				
			A	B	C	D	E	A	B	C	D	E
C3757	PA	Black	9.00	18.1X11.0	14.80	1.20	17.9X10.95	0.351	0.701x0.429	0.577	0.047	0.698x0.427
C0885	PA	Black	9.05	12.7x9.75	10.80	1.95	10.65x13.45	0.353	0.495x0.382	0.421	0.076	0.417x0.527
C1889	PA	Black	9.10	20.10	16.65	2.80	11.4x15.2	0.355	0.784	0.649	0.109	0.445x0.593
C0854	PA	Black	9.25	18.00	21.05	2.20	9.80	0.361	0.702	0.821	0.086	0.382
C3688	POM	Black	9.40	21.70	18.85	3.95	15.55x13.2	0.367	0.846	0.735	0.154	0.303x0.515
C3771	POM	Black	9.70	17.70	15.00	2.80	7.00	0.378	0.690	0.585	0.109	0.273
C0469	PA	Black	9.80	18.95x14.9	17.60	2.50	7.20	0.382	0.737x0.581	0.686	0.098	0.281
C1426	PP	Black	10.10	17.10	20.50	2.00	21.80	0.394	0.667	0.800	0.078	0.850
C1428	PP	Black	10.10	17.20	20.50	2.10	21.90	0.394	0.671	0.800	0.082	0.854
C0929	PA	Gery/ Black/ Dark grey/	10.12	18.35	13.40	1.60	14.80	0.395	0.716	0.523	0.062	0.577
C0852	PA	Black	10.40	17.90	21.00	2.12	9.80	0.406	0.698	0.819	0.083	0.382
C0149	PA	Brown	10.95	25.35	26.00	3.70	10.30	0.427	0.989	1.014	0.144	0.402
C0434	PA	Black	11.00	25.40	22.75	3.50	10.00	0.429	0.991	0.887	0.137	0.390
C0358	PA	Black	11.10	16.70	18.20	2.15	7.10	0.433	0.651	0.710	0.084	0.277
C0471	PA	Black	11.10	25.30	21.70	3.80	9.95	0.433	0.987	0.846	0.148	0.388
C1310	PA	Black	11.20	24.60	16.60	2.35	12.05	0.437	0.959	0.647	0.092	0.470
C0435	POM	Blue	11.30	21.80	23.50	3.60	10.00	0.441	0.850	0.917	0.140	0.390
C0676	POM	Blue	11.30	21.80	23.50	3.60	10.00	0.441	0.850	0.917	0.140	0.390
C1748	PA	Black	13.60	24.05	15.00	2.10	11.80	0.530	0.938	0.585	0.082	0.460

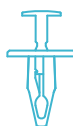

**C0039**  
**Material:** PA  
**Color:** Black  
**Dashboard**



**C0043**  
**Material:** PA  
**Color:** Black  
**Expanding retainer**



**C0046**  
**Material:** PA  
**Color:** Black  
**Dashboard, fan**



**C0047**  
**Material:** PA  
**Color:** Black  
**Dashboard, rocker panel, front and rear fascia, quarter panel**

# PUSH TYPE RETAINER

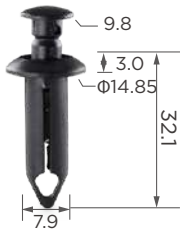

C0069

**Material:** PA  
**Color:** Black  
**Front and rear bumper, seat belt, door panel**



C0071

**Material:** PA  
**Color:** Black  
**Expanding retainer**

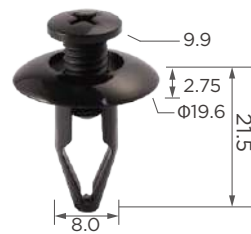

C0109

**Material:** PA  
**Color:** Black  
**Front bumper, wheelarch, floor attachment, fender**



C0110

**Material:** PA  
**Color:** Black  
**Rear bumper**



C0111

**Material:** PA  
**Color:** Black  
**Front and rear bumper, cowl**



C0115

**Material:** PA  
**Color:** Black  
**Front and rear bumper**



C0116

**Material:** PA  
**Color:** Black  
**Front and rear bumper**



C0117

**Material:** PA  
**Color:** Black  
**Front and rear bumper, front end, radiator mounting**



C0121

**Material:** PA  
**Color:** Black  
**Expanding retainer**

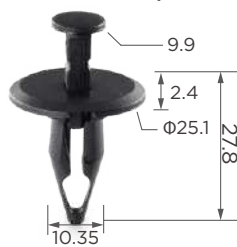

C0159

**Material:** PA  
**Color:** Black  
**Expanding retainer**



C0160

**Material:** PA  
**Color:** Black  
**Front and rear bumper**



C0168

**Material:** PA  
**Color:** Black  
**Front bumper**

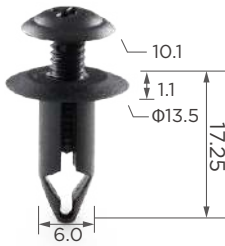

C0181

**Material:** PA  
**Color:** Black  
**Cowl, headlight, windshield washer, dashboard, spoiler**



C0188

**Material:** PA  
**Color:** Black  
**Front and rear bumper, front end**

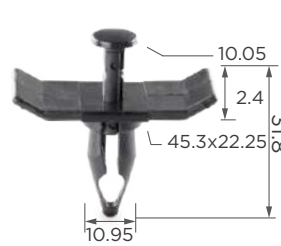

C0192

**Material:** PA  
**Color:** Black  
**Front and rear bumper, fender**



C0193

**Material:** PA  
**Color:** Black  
**Cowl, shields, wheelarch**



C0195

**Material:** PA  
**Color:** Black  
**Radiator mounting**

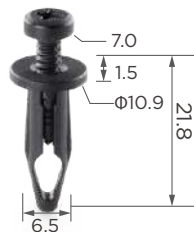

C0240

**Material:** PA  
**Color:** Black  
**Dashboard**



C0253

**Material:** PA  
**Color:** Black  
**Expanding retainer**



C0280

**Material:** PA  
**Color:** Black  
**Bumper fascia**



# PUSH TYPE RETAINER



C0281

**Material:** PA  
**Color:** Black  
*Front and rear bumper*

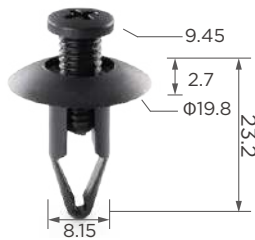

C0321

**Material:** PA  
**Color:** Black  
*Expanding retainer*



C0334

**Material:** PA  
**Color:** Black/ Grey/ Beige  
*Expanding retainer*

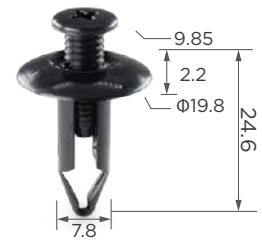

C0338

**Material:** PA  
**Color:** Black  
*Back seat, engine, rocker panel*



C0339

**Material:** PA  
**Color:** Black  
*Rear tray, tail lamp, fuel pump*



C0341

**Material:** PA  
**Color:** Black  
*Front and rear bumper, splash guard, wheelarch*



C0465

**Material:** PA  
**Color:** Black  
*Seat, arm rest, splash shield*



C0473

**Material:** PA  
**Color:** Black  
*Bumper fascia*



C0474

**Material:** PA  
**Color:** Black  
*Rear bumper, wheelarch, air cleaner, front wiper, hood shield*



C0475

**Material:** PA  
**Color:** Black  
*Engine coolant fan, front bumper, radiator mounting, front end*



C0506

**Material:** PA  
**Color:** Black  
*Rear panel*



C0507

**Material:** PA  
**Color:** Black  
*Rear bumper*

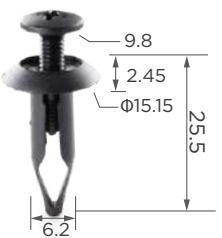

C0508

**Material:** PA  
**Color:** Black  
*Rear bumper, seat*

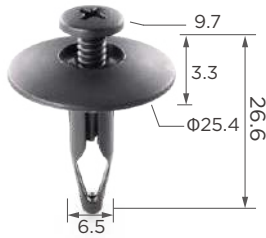

C0509

**Material:** PA  
**Color:** Black  
*Front bumper, grille, cowl, spoiler*

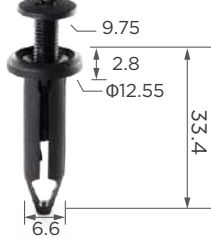

C0510

**Material:** PA  
**Color:** Black  
*Rear bumper, deck lid and related part*

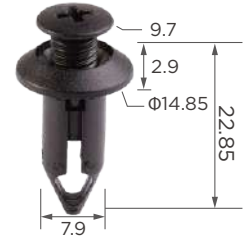

C0512

**Material:** PA  
**Color:** Black/ Yellow  
*Rear bumper, wheelarch*



C0513

**Material:** PA  
**Color:** Black  
*Expanding retainer*

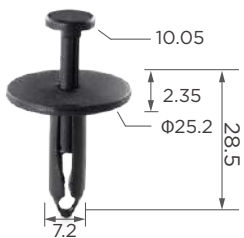

C0532

**Material:** PA  
**Color:** Black  
*Splash shield, seat*



C0533

**Material:** PA  
**Color:** Black  
*Expanding retainer*



C0542

**Material:** PA  
**Color:** Black  
*Expanding retainer*

# PUSH TYPE RETAINER

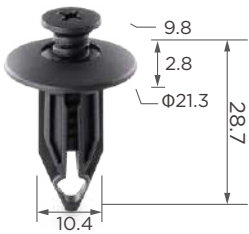

C0544

**Material:** PA  
**Color:** Black  
**Door panel**



C0559

**Material:** PA  
**Color:** Black  
**Bumper fascia**



C0568

**Material:** PA  
**Color:** Black/ Grey/ Grey yellow  
**Front and rear bumper, grille, side moulding, rocker panel, wheelarch, spoiler**



C0569

**Material:** PA  
**Color:** Black  
**Cowl, wheelarch, front bumper**



C0573

**Material:** PA  
**Color:** Black  
**Front and rear bumper, grille, wheelarch, floor attachment**



C0574

**Material:** PA  
**Color:** Black  
**Rocker panel**

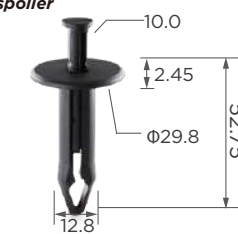

C0576

**Material:** PA  
**Color:** Black  
**Front and rear bumper**



C0584

**Material:** PA  
**Color:** Black  
**Front and rear bumper**

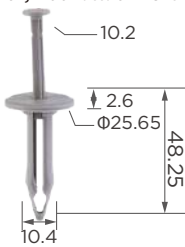

C0594

**Material:** PA  
**Color:** Grey  
**Expanding retainer**

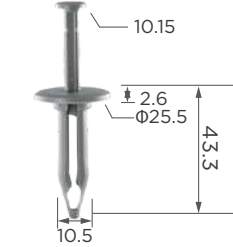

C0598

**Material:** PA  
**Color:** Grey  
**Front license plate**



C0602

**Material:** PA  
**Color:** Black  
**Front bumper**



C0605

**Material:** PA  
**Color:** Black  
**Cowl, pillar garnish, wheelarch, rear bumper**

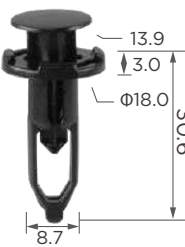

C0611

**Material:** PA  
**Color:** Black  
**Front and rear bumper, grille, dashboard**



C0614

**Material:** PA  
**Color:** Black  
**Floor attachment, spoiler**



C0615

**Material:** PA  
**Color:** Black  
**Floor attachment, fender flare**



C0632

**Material:** PA  
**Color:** Beige  
**Front and rear bumper**



C0645

**Material:** PA  
**Color:** Black  
**Front and rear bumper, grille**



C0655

**Material:** PA  
**Color:** Black  
**Rear bumper**



C0657

**Material:** PA  
**Color:** Black  
**Front bumper**



C0659

**Material:** PA  
**Color:** Black  
**Front and rear bumper, fender flare**

# PUSH TYPE RETAINER

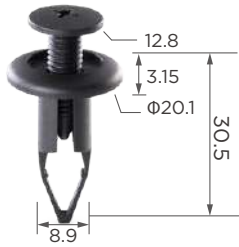

C0666

**Material:** PA  
**Color:** Black  
*Front and rear bumper*



C0672

**Material:** PA  
**Color:** Black  
*Dashboard, radiator*

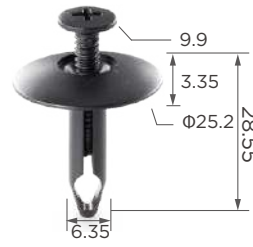

C0681

**Material:** PA  
**Color:** Black  
*Radiator mouting, frond end*



C0705

**Material:** PA  
**Color:** Black  
*Expanding retainer*



C0831

**Material:** PA  
**Color:** Black  
*Front bumper, wheelarch, quater panel, underbody shield, air cleaner, cowl*

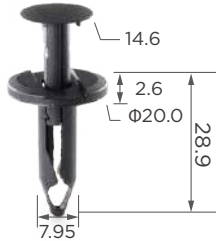

C0886

**Material:** PA  
**Color:** Black  
*Front and rear bumper, front end*

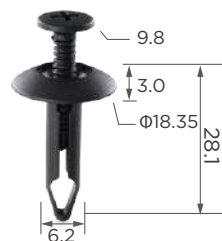

C0956

**Material:** PA  
**Color:** Black  
*Expanding retainer*

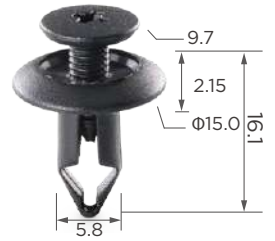

C1103

**Material:** PA  
**Color:** Black  
*Fuel filler tube, cowl, grille*

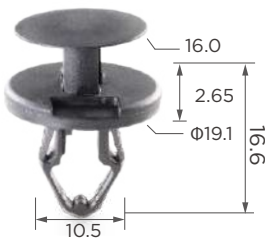

C1147

**Material:** PA  
**Color:** Black  
*Door panel*

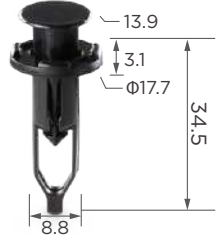

C1178

**Material:** PA  
**Color:** Black  
*Front and rear bumper*



C1272

**Material:** PA  
**Color:** Black  
*Front bumper*



C1313

**Material:** PA  
**Color:** Black  
*Front and rear bumper, wheelarch*

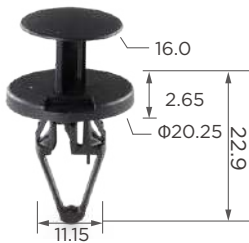

C1337

**Material:** PA  
**Color:** Black  
*Expanding retainer*

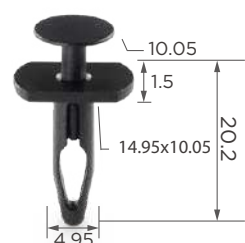

C1408

**Material:** PA  
**Color:** Black  
*Rear bumper*



C1448

**Material:** PA  
**Color:** Black  
*Hood*



C1449

**Material:** PA  
**Color:** Beige  
*Expanding retainer*

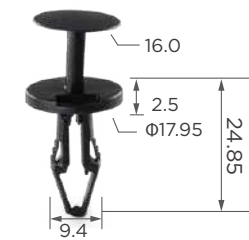

C1510

**Material:** PA  
**Color:** Black  
*Engine cover, grille, floor attachment*



C1511

**Material:** PA  
**Color:** Black  
*Front and rear bumper, wiper washer, rear tray, dashboard*

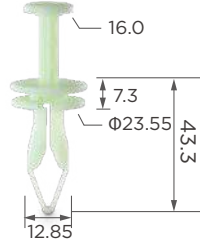

C1663

**Material:** PA  
**Color:** Light green  
*Radiator mounting, front end*



C1687

**Material:** PA  
**Color:** Black  
*Air intake system*

# PUSH TYPE RETAINER

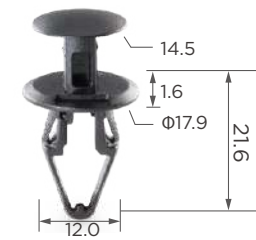

**C1731**  
**Material:** PA  
**Color:** Black  
*Raditor mounting, wheelarch*



**C1733**  
**Material:** PA  
**Color:** Black  
*Bumper cover*



**C1769**  
**Material:** PA  
**Color:** Black  
*Front bumper, grille, floor attachment, side moulding*



**C1772**  
**Material:** PA  
**Color:** Black  
*Front bumper*



**C1774**  
**Material:** PA  
**Color:** Black  
*Rocker panel*

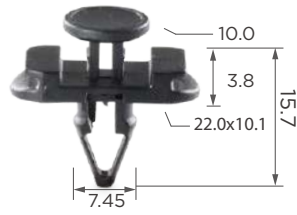

**C1791**  
**Material:** PA  
**Color:** Black  
*Door panel*



**C1804**  
**Material:** PA  
**Color:** Black  
*Wheelarch, headlight, rocker panel, splash guard, front bumper*



**C1864**  
**Material:** PA  
**Color:** Black  
*Rear tray*



**C1887**  
**Material:** PA  
**Color:** Black  
*Front and rear bumper, engine cover, grille*



**C1914**  
**Material:** PA  
**Color:** Black  
*Front bumper, front end, wheelarch*



**C1948**  
**Material:** PA  
**Color:** Black  
*Expanding retainer*



**C3096**  
**Material:** PA  
**Color:** Black  
*Front bumper, grille, splash guard*



**C3176**  
**Material:** PA  
**Color:** Black  
*Rocker panel, seat*



**C3342**  
**Material:** PA  
**Color:** Black  
*Underbody panel & firewall insulation*



**C3363**  
**Material:** PA  
**Color:** Black  
*Front and rear bumper, dashboard, air conditioning*



**C3367**  
**Material:** PA  
**Color:** Beige  
*Roof headliner*



**C3368**  
**Material:** PA  
**Color:** Black  
*Mud shield*



**C3383**  
**Material:** PA  
**Color:** Black  
*Expanding retainer*

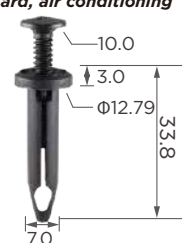

**C3474**  
**Material:** PA  
**Color:** Black  
*Expanding retainer*



**C3479**  
**Material:** PA  
**Color:** Black  
*Upper center pillar, rocker panel*

## PUSH TYPE RETAINER

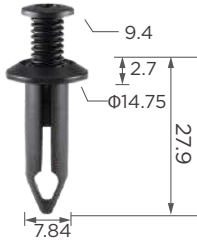

C3539

**Material:** PA  
**Color:** Black  
**Expanding retainer**

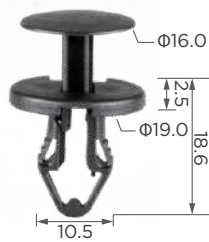

C3583

**Material:** PA  
**Color:** Black  
**Push type retainer**

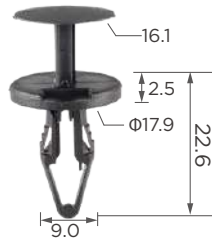

C3591

**Material:** PA  
**Color:** Black  
**Front bumper, side moulding**

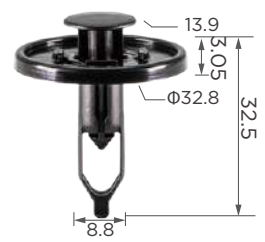

C3624

**Material:** POM  
**Color:** Black  
**Front bumper**

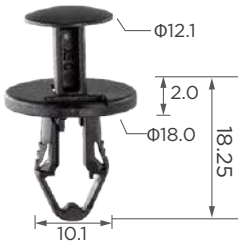

C3839

**Material:** PA  
**Color:** Black  
**Front undertray**

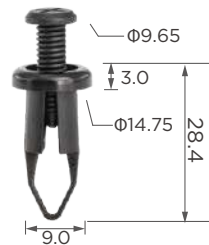

C3864

**Material:** PA  
**Color:** Black  
**Fender liner**

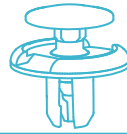

C0018

**Material:** PA  
**Color:** Black  
**Front and bumper, rocker panel, fender, engine mouting**



C0044

**Material:** PA  
**Color:** Black  
**Dashboard, splash guard, grille, wheelarch**



C0045

**Material:** PA  
**Color:** Black  
**Fender**



C0063

**Material:** POM  
**Color:** Black  
**Rear panel**



C0070

**Material:** PA  
**Color:** Black  
**Front bumper**



C0072

**Material:** PA  
**Color:** Black  
**Pillar garnish**



C0080

**Material:** PA  
**Color:** Black  
**Front bumper, cowl**



C0081

**Material:** PA  
**Color:** Black  
**Side molding, front and rear bumper**



# PUSH TYPE RETAINER



CO083

**Material:** PA  
**Color:** Black  
**Grille, hood**



CO091

**Material:** PA  
**Color:** Black  
**Hood, front bumper**



CO092

**Material:** PA  
**Color:** Black  
**Fender support**



CO122

**Material:** PA  
**Color:** Black  
**Rocker panel**



CO123

**Material:** PA  
**Color:** Black  
**Radiator support, front bumper**



CO128

**Material:** PA  
**Color:** Black  
**Rocker panel, splash guard, wheelarch**



CO133

**Material:** PA  
**Color:** Black  
**Cowl**

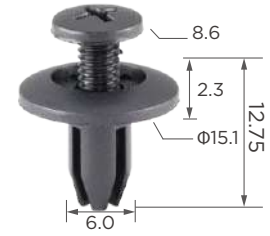

CO135

**Material:** PA  
**Color:** Black  
**Shelf back panel, rear seat, cowl**

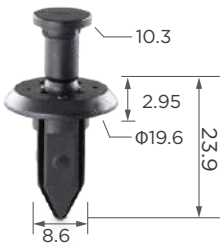

CO141

**Material:** PA  
**Color:** Black  
**Front and rear bumper, front end part**

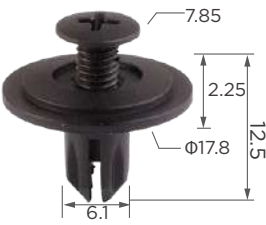

CO142

**Material:** PA  
**Color:** Black  
**Rocker panel**



CO148

**Material:** PA  
**Color:** Black  
**Cowl**



CO152

**Material:** PA  
**Color:** Black  
**Door weatherstrip**

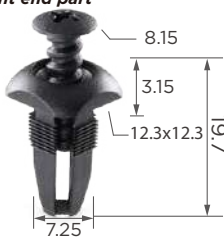

CO156

**Material:** PA  
**Color:** Black  
**Bumper fascia, grille**



CO158

**Material:** PA  
**Color:** Black  
**Floor attachment**



CO164

**Material:** PA  
**Color:** Black  
**Wheelarch**

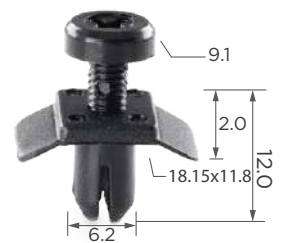

CO169

**Material:** PA  
**Color:** Black  
**Cowl**



CO173

**Material:** PA  
**Color:** Grey  
**Headliner**



CO175

**Material:** PA  
**Color:** Black  
**Splash guard, wheelarch**



CO176

**Material:** PA  
**Color:** Black  
**Grille**



CO178

**Material:** PA  
**Color:** Black  
**Door panel**

# PUSH TYPE RETAINER



C0216

**Material:** PA  
**Color:** Black  
**Wheelarch**



C0221

**Material:** PA  
**Color:** Black/ Beige  
**Expanding retainer**



C0234

**Material:** PA  
**Color:** Black  
**Side moulding**

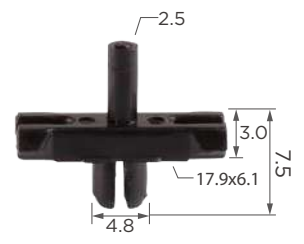

C0235

**Material:** POM  
**Color:** Black  
**Body moulding**



C0236

**Material:** PA  
**Color:** Black  
**Rear bumper**



C0248

**Material:** PA  
**Color:** Black  
**Splash guard, wheelarch, fender, side moulding**



C0251

**Material:** PA  
**Color:** White  
**Expanding retainer**

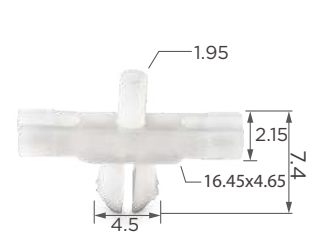

C0252

**Material:** PA  
**Color:** White  
**Expanding retainer**

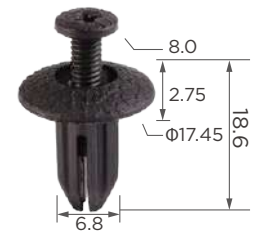

C0273

**Material:** PA  
**Color:** Black  
**Floor attachment**



C0277

**Material:** PA  
**Color:** Black  
**Expanding retainer**

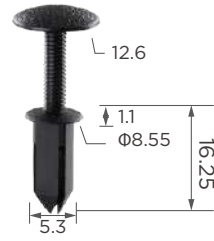

C0319

**Material:** PA  
**Color:** Black  
**Expanding retainer**



C0325

**Material:** PA  
**Color:** Black  
**Splash guard, floor attachment**



C0337

**Material:** PA  
**Color:** Black  
**Cowl**



C0374

**Material:** PA  
**Color:** Black  
**Expanding retainer**



C0395

**Material:** PA  
**Color:** Black  
**Front and rear bumper, grille, loose panel, carpet and scuff plate**



C0425

**Material:** PA  
**Color:** Black  
**Grille**



C0426

**Material:** PA  
**Color:** Black  
**Grille**

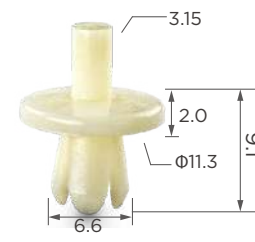

C0429

**Material:** PA  
**Color:** Beige  
**Air conditioning**

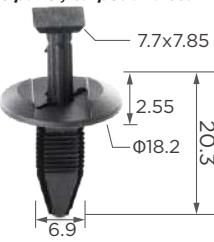

C0538

**Material:** PA  
**Color:** Black  
**Front bumper**



C0556

**Material:** PA  
**Color:** Black  
**Hood, tail light, front bumper**

# PUSH TYPE RETAINER



C0560

**Material:** PA  
**Color:** Black  
**Front lamp**



C0570

**Material:** PA  
**Color:** Black/ White  
**Front bumper, side moulding**



C0578

**Material:** PA  
**Color:** Black  
**Front bumper, cowl, rear tray**



C0618

**Material:** PA  
**Color:** Black/ Grey  
**Rear wiper**



C0623

**Material:** PA  
**Color:** Black  
**Wheelarch, splash guard, hood**



C0641

**Material:** POM  
**Color:** Black  
**Rocker panel**



C0677

**Material:** PA  
**Color:** Black  
**Expanding retainer**



C0678

**Material:** PA  
**Color:** Black  
**Rocker panel, wheelarch**



C0700

**Material:** PA  
**Color:** Black  
**Expanding retainer**



C0701

**Material:** PA  
**Color:** Black  
**Expanding retainer**



C0702

**Material:** PA  
**Color:** Black  
**Hood, front bumper**



C0803

**Material:** POM  
**Color:** Black  
**Wheelarch, fender**



C0833

**Material:** POM  
**Color:** Black  
**Floor attachment, tube**



C0835

**Material:** POM  
**Color:** Black  
**Expanding retainer**



C0837

**Material:** POM  
**Color:** Black  
**Rear tray, front fender**



C0846

**Material:** PA  
**Color:** Black  
**Rear tray, tube**



C0869

**Material:** POM  
**Color:** Black/ Black grey/ Grey  
**Seat**



C0880

**Material:** PA  
**Color:** Black/ Dark grey  
**Front floor, engine**



C0883

**Material:** PA  
**Color:** Black  
**Rear panel**



C0893

**Material:** POM  
**Color:** Black  
**Rear door panel**

# PUSH TYPE RETAINER



**C0899**

**Material:** POM  
**Color:** Black  
*Splash guard*



**C0934**

**Material:** Nylon  
**Color:** White  
*Rocker panel*

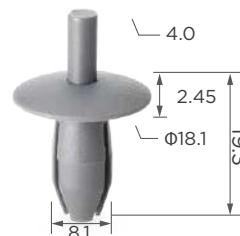

**C0938**

**Material:** PA  
**Color:** Grey  
*Rear panel*



**C0944**

**Material:** PA  
**Color:** White  
*Rocker panel*

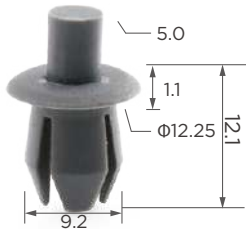

**C0947**

**Material:** PA  
**Color:** Grey  
*Rocker panel, front head, rear bumper*



**C0957**

**Material:** PA  
**Color:** Black  
*Rear tray, pillar garnish*



**C0998**

**Material:** POM  
**Color:** Black  
*Rocker panel*



**C0999**

**Material:** POM  
**Color:** Black  
*Rear door panel*



**C1068**

**Material:** PA  
**Color:** Black  
*Expanding retainer*



**C1069**

**Material:** PA  
**Color:** Black  
*Expanding retainer*



**C1071**

**Material:** PA  
**Color:** Black  
*Expanding retainer*



**C1072**

**Material:** PA  
**Color:** Black  
*Expanding retainer*



**C1073**

**Material:** PA  
**Color:** Black  
*Expanding retainer*



**C1074**

**Material:** PA  
**Color:** Black  
*Expanding retainer*



**C1075**

**Material:** PA  
**Color:** Black  
*Expanding retainer*



**C1076**

**Material:** PA  
**Color:** Black  
*Expanding retainer*



**C1077**

**Material:** PA  
**Color:** Black  
*Expanding retainer*



**C1078**

**Material:** PA  
**Color:** Black  
*Expanding retainer*



**C1079**

**Material:** PA  
**Color:** Black  
*Expanding retainer*



**C1080**

**Material:** PA  
**Color:** Black  
*Expanding retainer*

# PUSH TYPE RETAINER



**C1081**

**Material:** PA  
**Color:** Black  
**Expanding retainer**



**C1082**

**Material:** PA  
**Color:** Black  
**Expanding retainer**



**C1083**

**Material:** PA  
**Color:** Black  
**Expanding retainer**



**C1084**

**Material:** PA  
**Color:** Black  
**Expanding retainer**



**C1107**

**Material:** POM  
**Color:** Black  
**Front and rear bumper, grille, under cover, rocker panel**



**C1150**

**Material:** PA  
**Color:** Black  
**Floor attachment, front head, tube**



**C1177**

**Material:** PA  
**Color:** Dark grey/ Black  
**Rear bumper**



**C1224**

**Material:** POM  
**Color:** Black/ White  
**Expanding retainer**



**C1225**

**Material:** POM  
**Color:** Black  
**Expanding retainer**

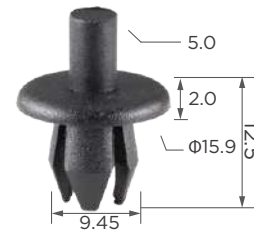

**C1285**

**Material:** PA  
**Color:** Beige  
**Door panel, front and rear bumper**



**C1318**

**Material:** PA  
**Color:** Black  
**Expanding retainer**



**C1324**

**Material:** POM  
**Color:** Black  
**Expanding retainer**



**C1343**

**Material:** POM  
**Color:** Black  
**Expanding retainer**



**C1359**

**Material:** POM  
**Color:** Black  
**Wheelarch, turn light**



**C1382**

**Material:** PA  
**Color:** Black  
**Door panel**



**C1399**

**Material:** PA  
**Color:** Black  
**Dashboard, inside fender, wheelarch**



**C1418**

**Material:** PA  
**Color:** Black/ Dark grey  
**Door trim panel**



**C1421**

**Material:** PA  
**Color:** Black  
**Floor attachment, front bumper**



**C1430**

**Material:** PA  
**Color:** Black  
**Radiator support**



**C1444**

**Material:** PA  
**Color:** Black  
**Grille**



# PUSH TYPE RETAINER



C1445

**Material:** PA  
**Color:** Black  
**Fender**



C1452

**Material:** PA  
**Color:** Black  
**Fuel pump, wheelarch, fender, side moulding**



C1453

**Material:** PA  
**Color:** Black  
**Expanding retainer**

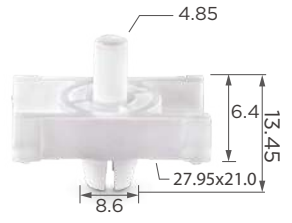

C1488

**Material:** POM  
**Color:** Natural  
**Side moulding, rocker panel**



C1507

**Material:** POM  
**Color:** Black  
**Cowl, grille, splash guard, headlight**



C1509

**Material:** POM  
**Color:** Black  
**Rocker panel, wheelarch**



C1518

**Material:** POM  
**Color:** Black  
**Front and rear bumper, floor attachment, grille, splash guard**



C1525

**Material:** POM  
**Color:** Black  
**Front bumper**

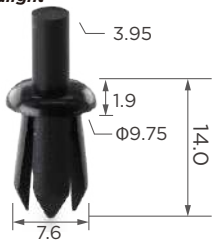

C1532

**Material:** PA  
**Color:** Black  
**Grille, rear tray, rear window shelf**

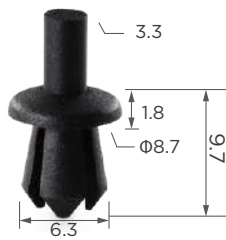

C1534

**Material:** PA  
**Color:** Black  
**Covering, fender**



C1542

**Material:** PA  
**Color:** Black  
**Cowl, grille, splash guard, front and rear bumper**



C1544

**Material:** PA  
**Color:** Black  
**Splash guard, seat, rear tray, side moulding**



C1553

**Material:** PA  
**Color:** Black  
**Front head, engine cover, wheelarch, air cleaner**



C1580

**Material:** PA  
**Color:** Black  
**Pillar garnish, rear tray**



C1582

**Material:** PA  
**Color:** Black  
**Hood**

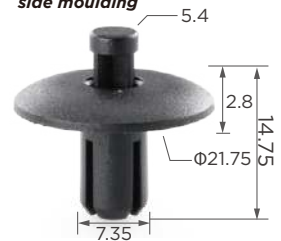

C1611

**Material:** PA  
**Color:** Black  
**Floor attachment, front and rear bumper, hood, wheelarch, pillar**



C1622

**Material:** PA  
**Color:** Black  
**Expanding retainer**



C1660

**Material:** PA  
**Color:** Black  
**Front window weatherstrip, rear tray, seat**



C1692

**Material:** POM  
**Color:** Black  
**Splash guard, dashboard, floor attachment**



C1704

**Material:** POM  
**Color:** Black  
**Splash guard**

# PUSH TYPE RETAINER



C1707

**Material:** PA  
**Color:** Black  
**Console, rocker panel, roof**



C1713

**Material:** POM  
**Color:** Black  
**Hood, wheelarch, splash garnish**



C1720

**Material:** POM  
**Color:** Black  
**Rocker panel, fender flare**



C1721

**Material:** PA  
**Color:** Black  
**Splash guard**



C1722

**Material:** POM  
**Color:** Black  
**Rocker panel, splash guard, cowl**



C1729

**Material:** POM  
**Color:** Black  
**Front and rear bumper, rear tray, engine covering, floor attachment**



C1735

**Material:** PA  
**Color:** Black  
**Front head, front and rear bumper, seat, hood**

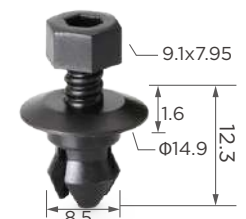

C1736

**Material:** POM  
**Color:** Black  
**Rocker panel**



C1745

**Material:** PA  
**Color:** Black  
**Windshield, quarter window, pillar garnish**



C1750

**Material:** PA  
**Color:** Black  
**Expanding retainer**



C1757

**Material:** POM  
**Color:** Black  
**Front bumper, headlight**



C1760

**Material:** PA  
**Color:** Black  
**Fuse box**



C1764

**Material:** PA  
**Color:** Black  
**Rear panel, battery, splash guard, front bumper**



C1765

**Material:** PA  
**Color:** Black  
**Front and rear bumper**



C1766

**Material:** PA  
**Color:** Black  
**Cowl, front bumper, rear tray**

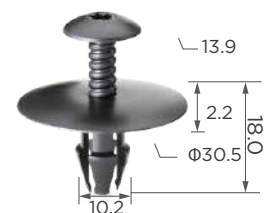

C1822

**Material:** POM  
**Color:** Black  
**Rocker panel**



C1849

**Material:** POM  
**Color:** Black  
**Rocker panel, side moulding**



C1850

**Material:** PA  
**Color:** Black  
**Seat, hood**



C1851

**Material:** PA  
**Color:** Black  
**Dashboard, inside fender, cowl**



C1873

**Material:** POM  
**Color:** Black  
**Rocker panel, splash guard**

# PUSH TYPE RETAINER



C1874

**Material:** PA  
**Color:** Black  
**Splash guard**



C1876

**Material:** POM  
**Color:** Black  
**Wheelarch**



C1886

**Material:** PA  
**Color:** Black  
**Rear bumper, tube**



C1918

**Material:** POM  
**Color:** Black  
**Air cleaner**



C1933

**Material:** POM  
**Color:** Black  
**Front and rear bumper, floor attachment, wheelarch**



C1934

**Material:** POM  
**Color:** Black  
**Floor attachment, roof, wheelarch, seat, rear tray, side moulding**



C1940

**Material:** PA  
**Color:** Black  
**Rocker panel**



C1945

**Material:** POM  
**Color:** Black  
**Cowl**

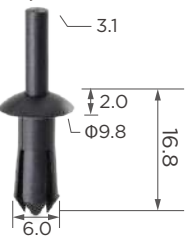

C1951

**Material:** PA  
**Color:** Black/ White  
**Door panel**



C1954

**Material:** PA  
**Color:** Dark grey  
**Dashboard, floor mat, radiator**

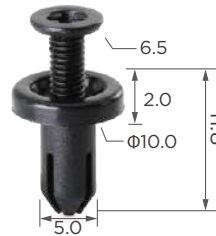

C1979

**Material:** PA  
**Color:** Black  
**Headlight, flash light, front bumper, air conditioning, spoiler**



C1981

**Material:** POM  
**Color:** Black  
**Rear bumper, cowl, floor attachment, fuel pump, wheelarch**



C1996

**Material:** PA  
**Color:** Black  
**Front bumper, seat, engine**



C3066

**Material:** PA  
**Color:** Brown  
**Door panel, rear bumper, floor attachment**



C3071

**Material:** PA  
**Color:** Black  
**Front bumper, rocker panel, fuel pump**



C3095

**Material:** PA  
**Color:** Black  
**Front bumper, wheelarch**



C3171

**Material:** POM  
**Color:** Black  
**Front bumper**



C3172

**Material:** POM  
**Color:** Grey  
**Expanding retainer**

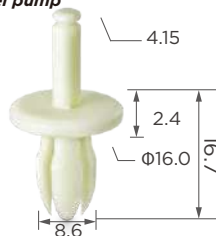

C3182

**Material:** PA  
**Color:** Light green  
**Door panel**



C3191

**Material:** PA  
**Color:** Black  
**Floor attachment, rocker panel, rocker panel**

# PUSH TYPE RETAINER



C3194

**Material:** POM  
**Color:** Black  
**Pillar garnish**



C3206

**Material:** PA  
**Color:** Black  
**Fender, seat belt**

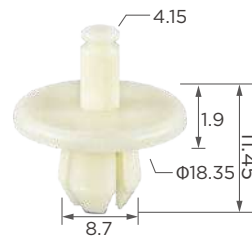

C3241

**Material:** PA  
**Color:** Light green  
**Rocker panel**



C3261

**Material:** PA  
**Color:** Grey/ Black  
**Rear panel**



C3277

**Material:** PA  
**Color:** Black  
**Rear tray**



C3312

**Material:** PA  
**Color:** Black  
**Floor attachment**



C3320

**Material:** PA  
**Color:** Black  
**Expanding retainer**



C3326

**Material:** POM  
**Color:** Black  
**Rear bumper, fuel pump**



C3328

**Material:** PA  
**Color:** Black  
**Rear bumper, rocker panel, front floor, wheelarch**



C3372

**Material:** PA  
**Color:** Black  
**Rear tray, rear panel**



C3570

**Material:** PA  
**Color:** Light green  
**Front bumper, grille**



C3585

**Material:** PA  
**Color:** Black  
**Expanding retainer**



C3619

**Material:** POM  
**Color:** Black  
**Spoiler, deflector**



C3620

**Material:** POM  
**Color:** Black  
**Front bumper, pillar**



C3626

**Material:** PA  
**Color:** Black  
**Hood, intake shell**

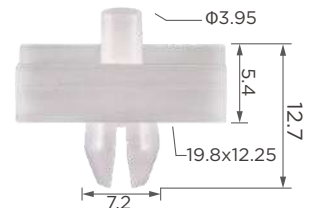

C3634

**Material:** POM  
**Color:** Natural  
**Rocker panel**



C3643

**Material:** PA  
**Color:** Black  
**Heat insulation, rear tray**



C3655

**Material:** POM  
**Color:** Black  
**Rear tray**



C3664

**Material:** POM  
**Color:** Black  
**Under cover**



C3739

**Material:** PA  
**Color:** Black  
**Expanding retainer**

# PUSH TYPE RETAINER

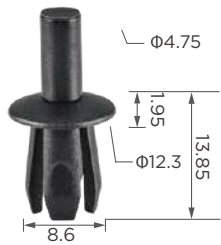

C3741

**Material:** PA  
**Color:** Black  
**Expanding retainer**

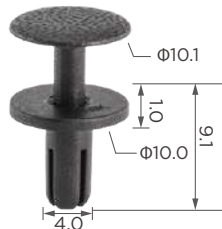

C3782

**Material:** PA  
**Color:** Black  
**Fender flare**



C3804

**Material:** POM  
**Color:** Black  
**Expanding Clip**



C3825

**Material:** POM  
**Color:** Black  
**Radiator suppt seal plate**



C3853

**Material:** PA  
**Color:** Black  
**Snap Rivet**

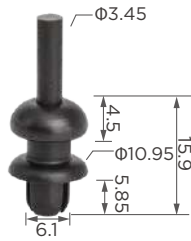

C3877

**Material:** PA  
**Color:** Black  
**Parcel Shelf Hanging**

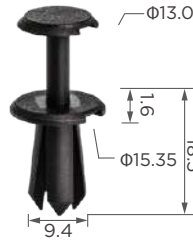

C3909

**Material:** PA  
**Color:** Black  
**Grille, heatshield under protection, air duct**

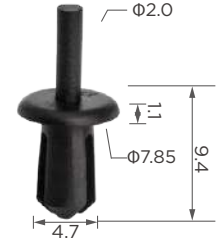

C3967

**Material:** POM  
**Color:** Black  
**Parking sensor, front bumper, front grille**

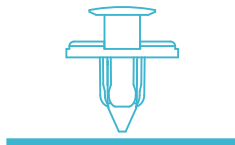

C0084

**Material:** POM  
**Color:** Black/White/Grey black/Yellow grey  
**Rear trunk, door panel, front bumper**



C0085

**Material:** POM  
**Color:** Black/ Grey  
**Front and rear bumper**



C0088

**Material:** POM  
**Color:** Black  
**Headlight, wheelarch, fuel pump, fender**



C0089

**Material:** POM  
**Color:** Black  
**Front and rear bumper, radiator support, splash guard**



C0090

**Material:** POM  
**Color:** Black  
**Wheelarch, fuel pump**



C0097

**Material:** POM  
**Color:** Black  
**Fender support**



C0107

**Material:** POM  
**Color:** Black  
**Cowl**



C0118

**Material:** PA  
**Color:** Black  
**Rear trunk, air filter, front bumper, rocker panel**



# PUSH TYPE RETAINER



C0136

**Material:** PA  
**Color:** Black  
**Door panel**



C0145

**Material:** POM  
**Color:** Black/ Dark grey  
**Rear tray**



C0189

**Material:** POM  
**Color:** Black/ Light grey/ Dark brown/ Dark grey  
**Dashboard, front bumper, side moldings**



C0215

**Material:** POM  
**Color:** Black  
**Front and rear bumper**



C0274

**Material:** POM  
**Color:** Grey/ Black  
**Door panel, dashboard**



C0276

**Material:** POM  
**Color:** Grey  
**Floor attachment, rear panel**

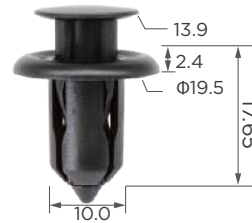

C0283

**Material:** POM  
**Color:** Black  
**Front and rear bumper, grille, rear door panel, floor attachment**



C0333

**Material:** POM  
**Color:** Black  
**Side moulding, dashboard**



C0351

**Material:** POM  
**Color:** Black  
**Tail light, side moulding**



C0354

**Material:** POM  
**Color:** Black  
**Hood, front bumper, splash guard**



C0376

**Material:** POM  
**Color:** Black  
**Pillar garnish**



C0390

**Material:** POM  
**Color:** Black/ Grey  
**Rear tray**



C0393

**Material:** PA  
**Color:** Grey  
**Air filter, front and rear bumper, door panel**



C0541

**Material:** POM  
**Color:** Black  
**Side moulding, windshield, splash guard, fender, floor attachment**



C0554

**Material:** PA  
**Color:** Black  
**Front bumper**

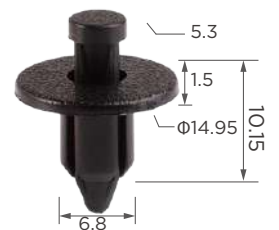

C0564

**Material:** POM  
**Color:** Black  
**Air cleaner, front end, hood, cowl, fender, wheelarch**



C0566

**Material:** POM  
**Color:** Black  
**Hood**

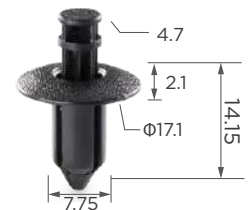

C0633

**Material:** POM  
**Color:** Black/ Grey  
**Rocker panel, handlebar, door panel, plate**



C0634

**Material:** POM  
**Color:** Black  
**Rocker panel, grille, bumper, splash guard**



C0636

**Material:** PA  
**Color:** Black  
**Splash guard, front panel, fender flare, front bumper**

# PUSH TYPE RETAINER



C0649

**Material:** POM  
**Color:** Black  
**Rocker panel**



C0653

**Material:** POM  
**Color:** Black  
**Hood, cowl**



C0680

**Material:** POM  
**Color:** Black  
**Console, interior moulding**



C0684

**Material:** PA  
**Color:** Grey  
**Floor console, air duct**



C0686

**Material:** POM  
**Color:** Black  
**Front bumper**

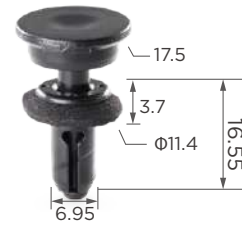

C0801

**Material:** POM  
**Color:** Black  
**Cowl, wheelarch**



C0824

**Material:** POM  
**Color:** Black/ Grey/ Beige  
**Expanding retainer**



C0882

**Material:** POM  
**Color:** Black  
**Rocker panel**



C0888

**Material:** POM  
**Color:** Black  
**Front and rear bumper**



C0955

**Material:** POM  
**Color:** Black  
**Front and rear bumper, grille, splash guard**

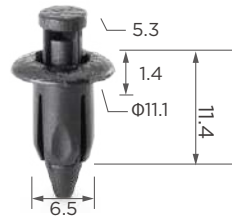

C0959

**Material:** POM  
**Color:** Black  
**Expanding retainer**



C0991

**Material:** POM  
**Color:** Black  
**Door lock handle**

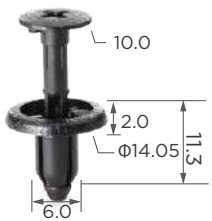

C0997

**Material:** POM  
**Color:** Black  
**Cowl**

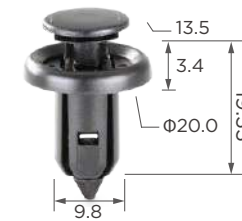

C1119

**Material:** POM  
**Color:** Black  
**Front and rear bumper, grille, splash guard, wheelarch**



C1153

**Material:** POM  
**Color:** Black  
**Cowl, splash guard, air cleaner**



C1267

**Material:** PA  
**Color:** Black  
**Cowl**



C1268

**Material:** PA  
**Color:** Black  
**Radiator mounting**

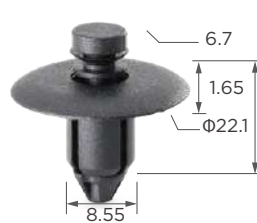

C1316

**Material:** PA  
**Color:** Black  
**Instrument box, door panel**



C1329

**Material:** POM  
**Color:** Black  
**Expanding retainer**



C1356

**Material:** POM  
**Color:** Black  
**Rocker panel, garnish moulding**

# PUSH TYPE RETAINER



C1419

**Material:** POM  
**Color:** Black  
*Front bumper, cowl*



C1420

**Material:** POM  
**Color:** Black  
*Pillar garnish*



C1526

**Material:** POM  
**Color:** Black  
*Back panel*



C1547

**Material:** POM  
**Color:** Black  
*Side moulding, dashboard, front bumper*



C1549

**Material:** POM  
**Color:** Black  
*Front and rear bumper, engine cover, grille*



C1564

**Material:** POM  
**Color:** Black  
*Expanding retainer*



C1684

**Material:** POM  
**Color:** Black  
*Air cleaner, cowl, engine cover*



C1714

**Material:** POM  
**Color:** Black  
*Wheelarch*

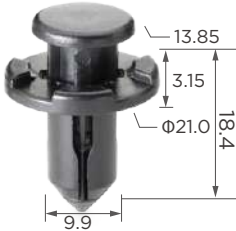

C1718

**Material:** POM  
**Color:** Black  
*Fuel pump, splash guard, engine cover, front and rear bumper, frog light*

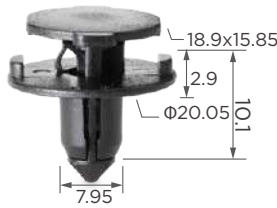

C1723

**Material:** POM  
**Color:** Black  
*Side moulding, splash guard, floor attachment*

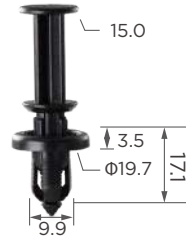

C1737

**Material:** POM  
**Color:** Black  
*Front and rear bumper*



C1739

**Material:** POM  
**Color:** Black  
*Front and rear bumper, rear tray, splash guard*



C1805

**Material:** PA  
**Color:** Black  
*Front bumper, grille, splash guard, dashboard, battery*



C3043

**Material:** PA  
**Color:** Black  
*Front bumper, floor attachment, grille, inside roof*



C3055

**Material:** POM  
**Color:** Black  
*Rear panel, front bumper*



C3076

**Material:** POM  
**Color:** Black  
*Silencer, engine under cover*



C3077

**Material:** POM  
**Color:** Black  
*Floor attachment, front bumper*



C3170

**Material:** POM  
**Color:** Black  
*Front bumper*



C3227

**Material:** POM  
**Color:** Black  
*Rocker panel*



C3345

**Material:** POM  
**Color:** Black  
*Wheelarch, air deflector, front and rear bumper*

## PUSH TYPE RETAINER



C3366

**Material:** POM  
**Color:** Black  
*Front bumper, hood*



C3410

**Material:** POM  
**Color:** Black  
*Floor attachment, cowl*



C3457

**Material:** POM  
**Color:** Black  
*Expanding retainer*



C3493

**Material:** PA  
**Color:** Dark grey  
*Door panel*



C3504

**Material:** POM  
**Color:** Dark grey  
*Expanding retainer*



C3549

**Material:** POM  
**Color:** Black  
*Cowl, roof moulding*



C3651

**Material:** POM  
**Color:** Black  
*Front bumper, cowl, fog light*



C3902

**Material:** POM  
**Color:** Black  
*Front and rear bumper*



C0019

**Material:** PA  
**Color:** Black  
*Cowl, ledge weatherstrip, guard liner*



C0041

**Material:** PA  
**Color:** Black  
*Front mud shirt*



C0144

**Material:** PA  
**Color:** Black  
*Fender shield*



C0149

**Material:** PA  
**Color:** Brown  
*Expanding retainer*



C0214

**Material:** PA  
**Color:** Black  
*Fender, rear panel*

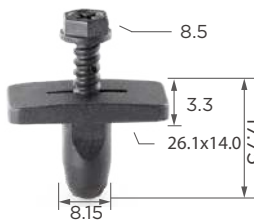

C0249

**Material:** PA  
**Color:** Black  
*Expanding retainer*



C0262

**Material:** PA  
**Color:** Black  
*Front and rear bumper, seat, rear tray shield*



C0264

**Material:** PA  
**Color:** Black  
*Expanding retainer*

# PUSH TYPE RETAINER

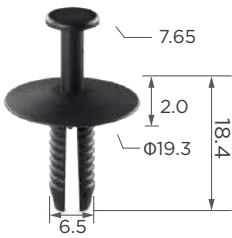

C0335

**Material:** PA  
**Color:** Black  
**Front and rear bumper, wheelarch**



C0358

**Material:** PA  
**Color:** Black  
**Expanding retainer**



C0373

**Material:** PA  
**Color:** Black  
**Expanding retainer**



C0434

**Material:** PA  
**Color:** Black  
**Front and rear bumper, dashboard, fuel pump**

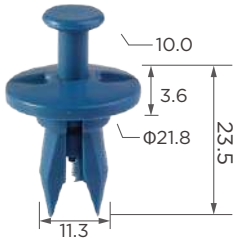

C0435

**Material:** POM  
**Color:** Blue  
**Wiring harness**

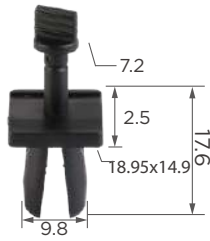

C0469

**Material:** PA  
**Color:** Black  
**Grille, front end**

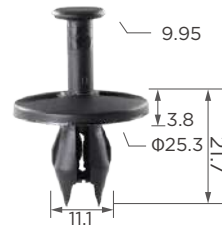

C0471

**Material:** PA  
**Color:** Black  
**Rocker panel, front splash guard**



C0472

**Material:** PA  
**Color:** Black  
**Wiring harness**

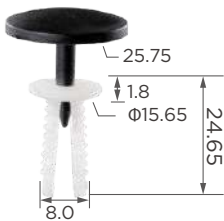

C0500

**Material:** PA  
**Color:** Black+Natural  
**Expanding retainer**



C0511

**Material:** PA  
**Color:** White  
**Expanding retainer**



C0526

**Material:** PA  
**Color:** Black  
**Expanding retainer**



C0530

**Material:** PA  
**Color:** Black  
**Expanding retainer**



C0595

**Material:** PA  
**Color:** Black  
**Heat shield**



C0597

**Material:** PA  
**Color:** Black  
**Front bumper**

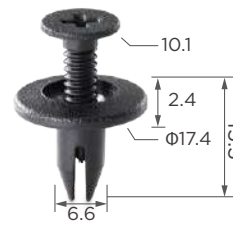

C0613

**Material:** PA  
**Color:** Black  
**Cowl, door panel**

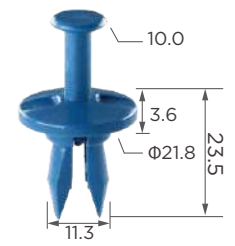

C0676

**Material:** POM  
**Color:** Blue  
**Expanding retainer**



C0682

**Material:** PA  
**Color:** Black  
**Hood, rear tray**

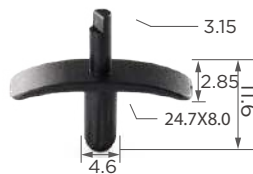

C0692

**Material:** PA  
**Color:** Black  
**Expanding retainer**



C0852

**Material:** PA  
**Color:** Black  
**Expanding retainer**



C0854

**Material:** PA  
**Color:** Black  
**Floor attachment**



# PUSH TYPE RETAINER



C0885

**Material:** PA  
**Color:** Black  
**Rear tray**



C0894

**Material:** PA  
**Color:** Black  
**Expanding retainer**



C0906

**Material:** PA  
**Color:** Black  
**Grille, rear tray**

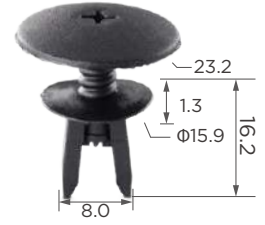

C0925

**Material:** PA  
**Color:** Black  
**Grille, rear tray, interior, light**

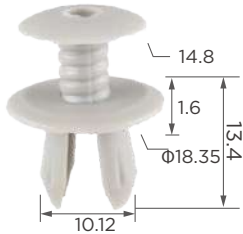

C0929

**Material:** PA  
**Color:** Grey/ Black/ Dark grey  
**Grille, wheelarch, front and rear bumper, door panel, seat**



C1219

**Material:** PA  
**Color:** Grey  
**Expanding retainer**



C1253

**Material:** PA  
**Color:** Black  
**Pillar garnish, rear tray, rear panel, front and rear bumper**



C1310

**Material:** PA  
**Color:** Black  
**Expanding retainer**



C1395

**Material:** PA  
**Color:** Black  
**Cowl**

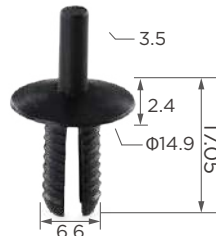

C1397

**Material:** PA  
**Color:** Black  
**Expanding retainer**



C1411

**Material:** PA  
**Color:** Black  
**Expanding retainer**



C1422

**Material:** PP  
**Color:** Black+Grey  
**Expanding retainer**



C1423

**Material:** PP  
**Color:** Black  
**Expanding retainer**

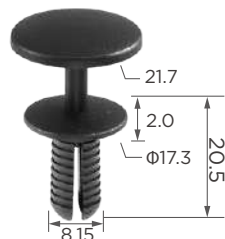

C1425

**Material:** PP  
**Color:** Black  
**Expanding retainer**



C1426

**Material:** PP  
**Color:** Black  
**Expanding retainer**



C1427

**Material:** PP  
**Color:** Black  
**Expanding retainer**



C1428

**Material:** PP  
**Color:** Black+Grey  
**Expanding retainer**



C1533

**Material:** PA  
**Color:** Black  
**Rear bumper**



C1536

**Material:** PA  
**Color:** Black  
**Rocker panel, floor attachment**



C1550

**Material:** PA  
**Color:** Black  
**Rocker panel, pillar garnish, fender, hood, rear tray**

# PUSH TYPE RETAINER



C1555

**Material:** PA  
**Color:** Black  
*Hood, rear panel, dashboard*

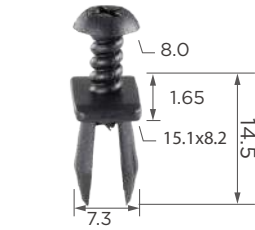

C1581

**Material:** PA  
**Color:** Black  
*Expanding retainer*

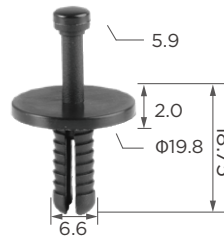

C1585

**Material:** PA  
**Color:** Black  
*Front bumper, pillar garnish, dashboard*



C1597

**Material:** PP  
**Color:** Dark grey/ Black  
*Expanding retainer*



C1679

**Material:** PA  
**Color:** BGrey black/ Black  
*Rear tray, rear panel*



C1683

**Material:** PA  
**Color:** Black  
*Headlight, front end, rear bumper*



C1711

**Material:** PA  
**Color:** Black  
*Seat, door panel, dashboard*



C1748

**Material:** PA  
**Color:** Black  
*Floor attachment, cowl*



C1771

**Material:** PA  
**Color:** Black  
*Rear tray, rear panel, seat*



C1790

**Material:** PA  
**Color:** Black  
*Console*



C1806

**Material:** PA  
**Color:** Black  
*Seat, rear bumper, engine cover, wheelarch*

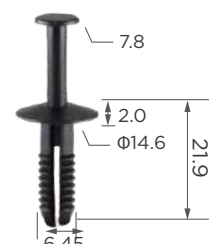

C1852

**Material:** PA  
**Color:** Black  
*Front and rear bumper*



C1888

**Material:** PA  
**Color:** Black  
*Hood, fender*



C1889

**Material:** PA  
**Color:** Black  
*Front bumper, pillar*



C1999

**Material:** PA  
**Color:** Black  
*Front bumper*



C3084

**Material:** PA  
**Color:** Black  
*Rear bumper, grille, frog light*



C3173

**Material:** PA  
**Color:** Black  
*Rear tray, fan*

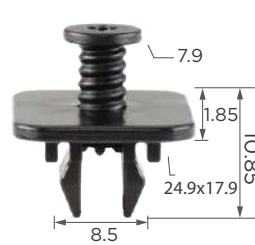

C3188

**Material:** POM  
**Color:** Black  
*Rear bumper*



C3207

**Material:** PA  
**Color:** Black+White  
*Rear bumper*



C3248

**Material:** PA  
**Color:** Black  
*Hood, front end*

# PUSH TYPE RETAINER

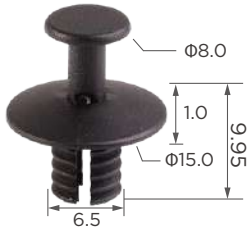

C3267

**Material:** PA  
**Color:** Black  
**Cowl, tube**

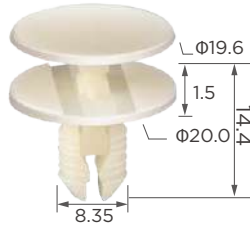

C3278

**Material:** PA  
**Color:** White  
**Rear panel**



C3565

**Material:** PA  
**Color:** Black  
**Grille**



C3581

**Material:** PP  
**Color:** Black  
**Expanding retainer**



C3610

**Material:** POM  
**Color:** Black  
**Front bumper, fender liner**



C3633

**Material:** PA  
**Color:** Black  
**Cowl**

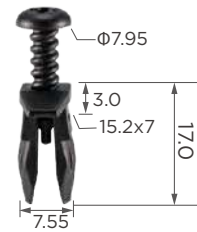

C3636

**Material:** PA  
**Color:** Black  
**Grille**

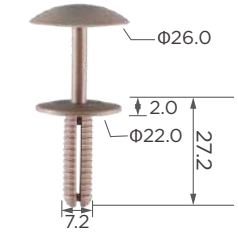

C3658

**Material:** PA  
**Color:** Brown  
**Expanding retainer**



C3688

**Material:** POM  
**Color:** Black  
**Cowl, front bumper**



C3696

**Material:** PA  
**Color:** Black  
**Retainer**



C3719

**Material:** PA  
**Color:** Black  
**Rear parcel shelf string cord hanger**



C3757

**Material:** PA  
**Color:** Black  
**Cowl, front windshield**



C3760

**Material:** PA  
**Color:** Black  
**Rocker panel, fender liner, front grille**

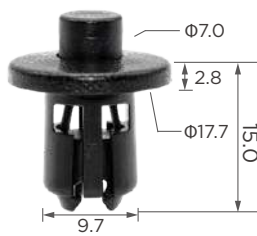

C3771

**Material:** POM  
**Color:** Black  
**Back Panel, front fender apron**

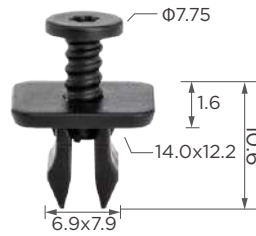

C3790

**Material:** POM  
**Color:** Black  
**Side molding, B pillar**



C3835

**Material:** POM  
**Color:** Black  
**Undershield, air duct, grille**



C3973

**Material:** PA  
**Color:** Black  
**Radio, rear trunk interior trim**

## — SCREW GROMMET & NUT

**Product No.: C0126**

**Material:** PA  
**Color:** Black  
**Position:** Door panel



Product Details

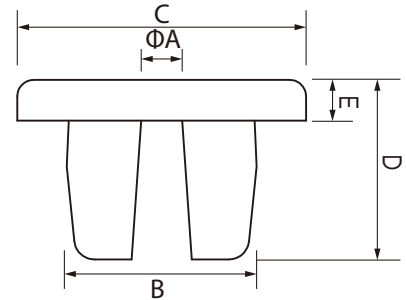

Part No.	Material	Color	mm					in				
			A	B	C	D	E	A	B	C	D	E
C3869	PA	White	2.10	6.75X6.10	9.65X9.65	6.95	0.58	0.082	0.263x0.238	0.376x0.376	0.271	0.023
C0179	PA	White	2.40	8.1X6.95	11.8X11.8	10.55	2.50	0.094	0.316x0.271	0.460x0.460	0.411	0.098
C0466	PA	Black	2.55	7.45x6.45	9.5x9.5	9.40	1.00	0.099	0.291x0.252	0.371x0.371	0.367	0.039
C0269	PA	White	2.70	6.8x6.0	9.6x9.6	8.15	0.90	0.105	0.265x0.234	0.374x0.374	0.318	0.035
C0024	PA	White	2.75	6.4x6.25	9.2x6.0	11.20	1.30	0.107	0.250x0.243	0.359x0.234	0.437	0.051
C0430	PA	White	2.80	7.7x6.65	9.8x9.8	9.50	1.00	0.109	0.300x0.259	0.382x0.382	0.371	0.039
C1455	PA	Natural	2.80	7.2x8.0	12.0x12.0	9.00	1.00	0.109	0.281x0.312	0.468x0.468	0.351	0.039
C3406	PA	Natural	2.80	7.6x6.6	9.5x9.5	7.90	0.80	0.109	0.296x0.257	0.371x0.371	0.308	0.031
C3517	PA	Black	2.85	7.6X7.0	9.55	9.30	1.20	0.111	0.296X0.273	0.372	0.363	0.047
C0504	PA	Blue	3.00	6.65x6.65	9.75x9.75	7.65	0.90	0.117	0.259x0.259	0.380x0.380	0.298	0.035
C1920	PA	Natural	3.00	6.7x7.8	10.1x7.6	14.15	1.95	0.117	0.261x0.304	0.394x0.296	0.552	0.076
C3051	PA	Natural	3.00	7.75x6.2	11.95	9.20	1.60	0.117	0.302x0.242	0.466	0.359	0.062
C3642	PA	Natural	3.35	7.8X7.1	10.75X10.75	8.15	0.90	0.131	0.304X0.277	0.419X0.419	0.318	0.035
C0025	PA	Beige	3.40	7.15x6.4	9.2x9.2	7.50	0.90	0.133	0.279x0.250	0.359x0.359	0.293	0.035
C0106	PA	White	3.40	6.4x6.4	9.5x9.5	12.00	0.90	0.133	0.250x0.250	0.371x0.371	0.468	0.035
C0265	PA	Beige	3.40	8.15x7.0	12.75	10.75	2.65	0.133	0.318x0.273	0.497	0.419	0.103
C3888	PA	Blue	3.40	8.6x7.85	11.0x11.0	9.10	1.50	0.133	0.335x0.306	0.429x0.429	0.355	0.059
C0433	PA	Beige	3.50	6.8x7.7	10.7x10.7	9.30	0.75	0.137	0.265x0.300	0.417x0.417	0.363	0.029
C1783	PA	Beige	3.50	8.4x7.6	12.1x12.1	10.15	1.50	0.137	0.328x0.296	0.472x0.472	0.396	0.059
C0313	PA	White	3.60	8.2x7.25	12.90	11.60	3.30	0.140	0.320x0.433	0.503	0.452	0.129
C3319	PA	Natural	3.60	10.55x9.75	12.45x12.65	16.05	1.50	0.140	0.411x0.380	0.486x0.493	0.626	0.059
C3492	PA	Pink red	3.70	8.3x8.45	16.9x18.7	13.70	8.50	0.144	0.324x0.330	0.659x0.729	0.534	0.332
C0900	PA	White	3.80	8.2x8.9	13.0x13.0	9.05	1.00	0.148	0.320x0.347	0.507x0.507	0.353	0.039
C1451	PA	Yellow	3.80	9.7x8.5	14.15x14.15	9.00	2.10	0.148	0.378x0.332	0.552x0.552	0.351	0.082
C0026	PA	Beige	3.90	8.45x8.6	12x12	12.15	1.75	0.152	0.330x0.335	0.468x0.468	0.474	0.068
C0129	PA	White	3.90	8.9x8.3	13x13	10.20	2.00	0.152	0.347x0.324	0.507x0.507	0.398	0.078
C3530	PA	Dark grey	3.90	9.85x8.95	17.70	11.30	1.45	0.152	0.384x0.349	0.690	0.441	0.057
C3679	PA	Beige	3.95	9.6x8.85	12.95x12.95	9.05	2.00	0.154	0.374x0.345	0.505x0.505	0.353	0.078
C0126	PA	Black	4.00	9.3x8.6	14x14	8.80	2.00	0.156	0.363x0.335	0.546x0.546	0.343	0.078

## SCREW GROMMET & NUT

Part No.	Material	Color	mm					in				
			A	B	C	D	E	A	B	C	D	E
C0481	PA	White	4.00	9.45x9.3	17.10	11.40	1.20	0.156	0.369x0.363	0.667	0.445	0.047
C0553	PA	Beige	4.00	8.2x9.1	13.4x13.4	9.40	1.00	0.156	0.320x0.355	0.523x0.523	0.367	0.039
C3574	PA	Natural	4.00	9.65x8.65	17.10	12.10	1.00	0.156	0.374x0.335	0.667	0.472	0.039
C3743	PA	Yellow	4.00	10.1x8.48	17.15	11.20	1.10	0.156	0.391x0.330	0.669	0.437	0.043
C1228	PA	Yellow	4.05	9.65x8.7	14.4x14.3	8.90	2.20	0.158	0.378x0.339	0.562x0.558	0.347	0.086
C1006	PA	White	4.10	9.9x8.55	14.3x14.3	10.70	2.00	0.160	0.386x0.333	0.558x0.558	0.417	0.078
C1454	PA	Natural	4.10	8.8x7.6	13.10	8.30	0.85	0.160	0.343x0.296	0.511	0.324	0.033
C1829	PA	Black	4.10	10.5x9.4	21.90	9.85	2.95	0.160	0.410x0.367	0.854	0.384	0.115
C1943	POM	Yellow	4.10	9.65x10.2	15.00	12.40	1.15	0.160	0.376x0.398	0.585	0.484	0.045
C0032	PA	White	4.20	8.2x8.3	16.6x16.6	10.10	2.25	0.164	0.320x0.324	0.647x0.647	0.394	0.088
C3402	PA	Natural	4.20	8.4x8.35	19.4x13.7	13.50	2.25	0.164	0.328x0.326	0.757x0.534	0.527	0.088
C0398	PA	Black	4.25	6.6x7.45	9.4x9.4	7.90	0.85	0.166	0.257x0.291	0.367x0.367	0.308	0.033
C0571	PA	Black/ White	4.25	9.2x7.65	15.05	11.00	1.10	0.166	0.359x0.295	0.587	0.429	0.043
C0130	PA	White	4.30	8.85x10.15	13.15x15.2	10.30	2.30	0.168	0.345x0.396	0.513x0.593	0.402	0.090
C0421	PA	Beige	4.30	10.2x9.9	19.5x15.6	9.70	2.00	0.168	0.398x0.386	0.761x0.608	0.378	0.078
C3048	PA	Grey	4.30	7.75x8.75	11.95x11.95	10.15	1.80	0.168	0.302x0.341	0.466x0.466	0.396	0.070
C0317	PA	White	4.40	9.25x8.2	15.00	10.05	2.05	0.172	0.361x0.320	0.585	0.392	0.080
C1968	PA	Natural	4.40	9.5x8.85	12.1x12.05	12.25	1.60	0.172	0.371x0.345	0.472x0.470	0.478	0.062
C3067	PA	Light green	4.40	10.1x9.45	20.15	12.50	2.55	0.172	0.394x0.368	0.786	0.488	0.099
C3035	PA	White	4.45	8.6x7.95	11.75x11.5	12.30	1.20	0.174	0.335x0.310	0.458x0.449	0.480	0.047
C3054	PA	Black	4.50	10.5x8.0	16.50	12.60	1.70	0.176	0.410x0.312	0.644	0.491	0.066
C0177	PA	White	4.60	7.9x6.25	9.5x9.5	9.10	0.70	0.179	0.308x0.244	0.371x0.371	0.355	0.027
C0971	PA	Black	4.60	10.35x7.95	16.40	12.40	1.60	0.179	0.404x0.310	0.640	0.484	0.062
C0180	PA	White	4.70	7.5x7.0	10.3x10.3	10.70	1.70	0.183	0.293x0.273	0.402x0.402	0.417	0.066
C1609	PA	Black	4.70	10.6x8.7	17.10	11.05	1.10	0.183	0.413x0.339	0.667	0.431	0.043
C1340	PA	White	4.80	10.8x10.6	16.05x14.05	11.60	1.53	0.187	0.421x0.413	0.624x0.546	0.452	0.060
C1471	PA	Natural	4.90	8.6x8.0	17.0x17.1	15.20	9.10	0.191	0.335x0.312	0.663x0.667	0.593	0.355
C1562	PA	Natural	5.00	9.5x10.4	15.9x15.9	10.70	2.00	0.195	0.371x0.406	0.620x0.620	0.417	0.078
C3907	PA	White	5.10	10.15x9.0	15.8x15.8	9.20	2.10	0.199	0.396x0.351	0.616x0.616	0.359	0.082
C1005	PA	White	5.15	8.8x9.7	14.00	12.40	2.55	0.201	0.343x0.378	0.546	0.484	0.099
C0387	PA	Beige	5.40	7.75x9.3	16.00	17.00	2.00	0.211	0.302x0.363	0.624	0.663	0.078
C0057	PA	Green	5.80	10.6x8.5	15.55x12.5	17.30	10.80	0.226	0.413x0.322	0.606x0.488	0.675	0.421
C1229	POM	White	6.30	9.05x10.1	28.20	10.75	2.45	0.246	0.353x0.394	1.100	0.419	0.096
C1529	PA	White	6.30	12.1x9.1	14.0x14.0	19.10	6.00	0.246	0.472x0.355	0.546x0.546	0.745	0.234
C1462	PA	Yellow	6.60	8.6x9.7	19.85x20.0	17.40	7.60	0.257	0.335x0.378	0.774x0.780	0.679	0.296
C1826	PA	Black	6.65	9.75x9.75	16.90	16.95	2.10	0.259	0.380x0.380	0.659	0.661	0.082
C1530	PA	Natural	6.80	8.1x8.85	16.20	17.50	9.60	0.265	0.316x0.345	0.632	0.683	0.374
C1391	PA	White	6.90	8.6x9.7	14.0x14.0	16.75	2.40	0.269	0.335x0.378	0.546x0.546	0.653	0.094
C1350	PA	White	8.10	9.7x8.8	17.25	11.95	1.10	0.316	0.378x0.343	0.673	0.466	0.043
C0839	PA	Black	9.50	7.8x8.1	16.00	16.20	3.10	0.371	0.304x0.316	0.624	0.632	0.121
C1390	PA	White	9.55	9.25x8.45	14.2x14.2	11.50	2.00	0.372	0.361x0.330	0.554x0.554	0.449	0.078
C0292	PA	Beige	9.60	7.9x11.1	18.1x15.8	11.90	1.20	0.374	0.308x0.433	0.706x0.616	0.464	0.047
C0222	PA	White	9.85	11.25x7.5	28x20.1	19.00	1.00	0.384	0.439x0.293	1.092x0.784	0.741	0.039
C0832	PA	White	11.6x3.3	8.0x12.1	12.0x14.9	10.10	2.50	0.452x0.129	0.312x0.472	0.468x0.581	0.394	0.098



## SCREW GROMMET & NUT

Part No.	Material	Color	mm					in				
			A	B	C	D	E	A	B	C	D	E
C0134	PA	White	6.05x2.6	7.0X10.1	12.2X16.0	9.40	1.80	0.246x0.098	0.273x0.394	0.476x0.624	0.367	0.070
C0860	PA	White	6.0x3.4	8.5x7.0	12.0x14.0	8.90	1.30	0.234x0.133	0.332x0.273	0.468x0.546	0.347	0.051
C1866	PA	Natural	6.4x4.35	10.75x9.7	16.05	12.10	1.00	0.250x0.170	0.419x0.378	0.626	0.472	0.039
C1465	PA	White	9.6x2.6	11.7x9.6	16.9x12.9	8.80	1.90	0.374x0.101	0.456x0.374	0.659x0.503	0.343	0.074

### Product No.: C0630

**Material:** PA  
**Color:** Black  
**Position:** Rocker panel, fender, splash guard



Product Details

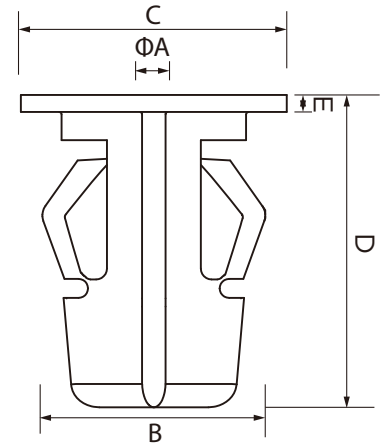

Part No.	Material	Color	mm					in				
			A	B	C	D	E	A	B	C	D	E
C3796	PA	Black	3.95	7.8x7.8	20.10	19.10	1.00	0.154	0.304x0.304	0.784	0.745	0.039
C1931	PA	Black	4.30	8.2x8.2	14.1x14.1	15.00	1.10	0.168	0.320x0.320	0.550x0.550	0.585	0.043
C3899	PA	Black	4.80	13.5x11.45	16.00	18.90	1.05	0.187	0.527x0.447	0.624	0.737	0.041
C0230	PA	Black	4.90	8.65x8.65	20.10	18.90	1.00	0.191	0.337x0.337	0.784	0.737	0.039
C3769	PA	Black	4.90	8.9x8.9	20.00	23.80	1.00	0.191	0.347x0.347	0.780	0.928	0.039
C3008	PA	Black	4.99	8.6x8.6	18.15	17.55	1.05	0.195	0.335x0.335	0.708	0.684	0.041
C0031	PA	Black	5.00	8.1X8.1	19.85	18.60	1.00	0.195	0.316x0.316	0.774	0.725	0.039
C1389	PA	Dark Grey	5.00	8.2x8.2	16.00	18.85	1.00	0.195	0.320x0.320	0.624	0.735	0.039
C1602	PA	Black	5.00	8.7x8.7	20.10	19.00	1.05	0.195	0.339x0.339	0.784	0.741	0.041
C0630	PA	Black	5.10	8.7x8.7	16.20	20.05	0.95	0.199	0.339x0.339	0.632	0.782	0.037
C0664	PA	Black	5.10	8.2x8.2	20.30	24.20	1.00	0.199	0.320x0.320	0.792	0.944	0.039
C1917	PA	Black	5.10	8.6x8.6	20.05	18.60	0.90	0.199	0.335x0.335	0.782	0.725	0.035
C3903	PA	Black	5.20	8.8X8.8	20.00	18.70	1.00	0.203	0.343X0.343	0.780	0.729	0.039
C1266	PA	Yellow	5.20	8.9x8.9	16.40	25.20	1.05	0.203	0.347x0.347	0.640	0.983	0.041
C0344	PA	Black	5.40	8.7x8.7	16.00	20.10	1.25	0.211	0.339x0.339	0.624	0.784	0.049

## SCREW GROMMET & NUT

Product No.: **C0033**

Material: **PA**  
Color: **Beige**  
Position: **Fender**

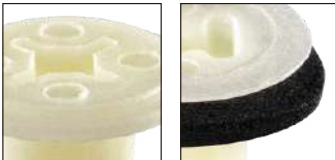

Product Details

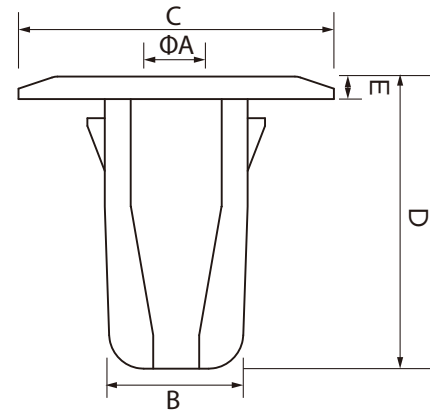

Part No.	Material	Color	mm					in				
			A	B	C	D	E	A	B	C	D	E
C0074	PA	Beige	1.80	6.8x6.8	13.25	17.60	0.70	0.070	0.265x0.265	0.517	0.686	0.027
C0381	PA	White	2.20	8.7x6.7	12.35	17.55	1.10	0.086	0.339x0.261	0.482	0.684	0.043
C0483	PA	White	2.25	6.9x6.9	14.10	11.75	1.50	0.088	0.269x0.269	0.550	0.458	0.059
C0389	PA	White	2.40	6.9x7.5	11.55	10.50	1.35	0.094	0.269x0.293	0.450	0.410	0.053
C0486	PA	White	2.40	7.05x7.05	13.50	18.00	1.60	0.094	0.275x0.275	0.527	0.702	0.062
C0809	PA	White	2.60	7.65x7.0	9.95x15.6	12.85	1.35	0.101	0.298x0.273	0.388x0.608	0.501	0.053
C0954	PA	White	2.60	8.2x9.3	15.3x15.3	15.90	1.50	0.101	0.320x0.363	0.597x0.597	0.620	0.059
C4032	PA	Natural	3.00	9.7x9.7	16.00	21.50	1.50	0.117	0.378x0.378	0.624	0.839	0.059
C3012	PA	Natural	3.05	7.6x7.6	14.20	17.75	1.80	0.119	0.296x0.296	0.554	0.692	0.070
C0383	PA	White	3.10	7.2x9.3	13.20	14.35	0.95	0.121	0.281x0.363	0.515	0.560	0.037
C1665	PA	White	3.10	12.1x10	20.00	16.80	1.50	0.121	0.472x0.390	0.780	0.655	0.059
C3753	PA	Natural	3.10	10.2x10.75	16.10	21.70	1.70	0.121	0.398x0.419	0.628	0.846	0.066
C0157	PA	Beige	3.30	7.6x7.45	14.30	16.60	1.45	0.129	0.296x0.291	0.558	0.647	0.057
C1784	PA	White	3.30	8.3x7.5	12.00	15.05	1.00	0.129	0.324x0.293	0.468	0.587	0.039
C1522	PA	White	3.40	10.6x7.3	21.9x16.0	18.10	1.80	0.133	0.413x0.285	0.854x0.624	0.706	0.070
C3250	PA	Natural	3.40	10.35x8.0	12.1x12.1	17.20	1.20	0.133	0.404x0.312	0.472x0.472	0.671	0.047
C0293	PA	White	3.50	9.1x9.1	15.00	17.00	2.00	0.137	0.355x0.355	0.585	0.663	0.078
C3423	PA	Light green	3.50	12.5x11.15	22.00	15.00	2.50	0.137	0.488x0.435	0.858	0.585	0.098
C0073	PA	Beige	3.55	7.3x6.85	9.9x9.9	17.55	0.85	0.138	0.285x0.267	0.386x0.386	0.684	0.033
C3951	PA	Beige	3.50	7.0x6.8	11.65	12.10	1.30	0.137	0.273x0.265	0.454	0.472	0.051
C1521	PA	White	3.55	11.0x7.2	22.0x16.3	21.70	1.60	0.138	0.429x0.281	0.858x0.636	0.846	0.062
C3262	PA	Grey	3.60	7.4x7.4	9.5x9.5	12.25	1.25	0.140	0.289x0.289	0.371x0.371	0.478	0.049
C3621	PA	Beige	3.61	10.65x8.65	16.00	18.25	4.00	0.141	0.415x0.337	0.624	0.712	0.156
C3556	PA	Natural	3.70	8.5x7.8	13.2x13.1	20.60	2.50	0.144	0.332x0.304	0.515x0.511	0.803	0.098
C3793	PA	Beige	3.85	8.85x9.10	16.30	17.55	1.45	0.150	0.345x0.355	0.636	0.684	0.057
C0075	PA	Beige	3.90	8.4x9.1	16.50	19.00	0.90	0.152	0.328x0.355	0.644	0.741	0.035
C3024	PA	Natural	4.00	8.5x8.5	18.15	22.10	1.30	0.156	0.332x0.332	0.708	0.862	0.051
C3036	PA	Natural	4.00	10.2x8.75	14.15x18.15	23.15	5.75	0.156	0.398x0.342	0.552x0.708	0.903	0.224
C0034	PA	Beige	4.10	8.6x8.6	16.20	18.85	1.50	0.160	0.335x0.335	0.632	0.735	0.059
C1915	PA	Natural	4.15	8.15x8.15	15.50	16.50	2.00	0.162	0.318x0.318	0.605	0.644	0.078
C3038	PA	Natural	4.15	8.4x10.3	18.0x14.1	23.10	5.30	0.162	0.328x0.402	0.702x0.550	0.901	0.207

## SCREW GROMMET & NUT

Part No.	Material	Color	mm					in				
			A	B	C	D	E	A	B	C	D	E
C3930	PA	Black	4.20	11.9x11.9	14.35x14.35	16.75	2.00	0.164	0.464x0.464	0.560x0.560	0.653	0.078
C3476	PA	Natural	4.20	8.2x8.25	15.20	20.25	2.00	0.164	0.320x0.322	0.593	0.790	0.078
C0033	PA	Beige	4.40	8.6x8.1	17.60	18.00	1.30	0.172	0.335x0.316	0.686	0.702	0.051
C0817	PA	Yellow	4.40	8.4x8.2	16.00	16.40	1.85	0.172	0.328x0.320	0.624	0.640	0.072
C1385	PA	White	4.40	9.7x10.3	20.30	20.20	2.00	0.172	0.378x0.402	0.792	0.788	0.078
C1341	PA	White	4.50	12.5x6.75	16.3x16.3	21.30	1.40	0.176	0.488x0.263	0.636x0.636	0.831	0.055
C3701	PA	Natural	4.50	7.9x8.2	13.0x13.0	19.10	1.00	0.176	0.308x0.320	0.507x0.507	0.745	0.039
C0996	PA	White	4.60	8.9x11.6	14.15x18.05	22.75	5.75	0.179	0.347x0.452	0.552x0.704	0.887	0.224
C1986	PA	Natural	4.60	12.2x9.7	14.10	20.30	3.15	0.179	0.476x0.378	0.550	0.792	0.123
C1467	PA	White	4.65	9.8x9.8	16.00	18.10	1.00	0.181	0.382x0.382	0.624	0.706	0.039
C1384	PA	White	4.70	9.4x8.6	20.00	22.00	1.50	0.183	0.367x0.335	0.780	0.858	0.059
C3216	PA	Yellow	4.70	12.4x9.95	14.05	18.80	2.95	0.183	0.484x0.388	0.548	0.733	0.115
C3231	POM	Natural	4.70	12.4x9.95	18.60	19.80	3.40	0.183	0.484x0.388	0.725	0.772	0.133
C0267	PA	White	4.95	8.3x8.3	18.30	21.40	1.25	0.193	0.324x0.324	0.714	0.835	0.049
C0482	PA	Beige	4.98	8.31x7.81	18.20	17.10	1.35	0.194	0.324x0.305	0.710	0.667	0.053
C1738	PA	Natural	5.00	9.25x8.6	18.25	18.35	1.85	0.195	0.361x0.335	0.712	0.716	0.072
C0287	PA	Bluish White	5.10	8.5x8.2	18.30	17.20	1.25	0.199	0.332x0.320	0.714	0.671	0.049
C0370	PA	White	5.10	8.75x8.7	18.00	18.00	1.10	0.199	0.341x0.339	0.702	0.702	0.043
C0976	PA	White	5.10	8.2x8.2	18.00	21.80	1.10	0.199	0.320x0.320	0.702	0.850	0.043
C1690	PA	Natural	5.10	8.8x8.15	18.20	17.75	3.35	0.199	0.343x0.318	0.710	0.692	0.131
C3443	PA	Light green	5.10	13.5x12.1	18.35x15.25	23.80	0.75	0.199	0.527x0.472	0.716x0.595	0.928	0.029
C1289	PA	Beige	5.15	9.8x12.75	12.3x12.3	18.90	1.00	0.201	0.382x0.497	0.480x0.480	0.737	0.039
C3218	PA	Natural	5.15	10.05x10.05	20.00	20.30	2.05	0.201	0.392x0.392	0.780	0.792	0.080
C3374	PA	Black	5.25	7.8x8.5	16.00	19.30	4.90	0.205	0.304x0.332	0.624	0.753	0.191
C0286	PA	White	5.30	10.7x8.3	16.10	16.25	1.50	0.207	0.417x0.324	0.628	0.634	0.059
C1269	POM	Black	5.50	10.55x8.3	20.05	13.95	1.60	0.215	0.411x0.324	0.782	0.544	0.062
C3560	PA	Natural	5.80	11.7x11.7	15.1x15.1	21.00	0.75	0.226	0.456x0.456	0.589x0.589	0.819	0.029
C3721	PA	Dark grey	5.80	9.3x9.3	10.05x10.05	26.00	3.00	0.226	0.362x0.362	0.392x0.392	1.014	0.117
C3508	PA	Natural	8.00	8.8x8.85	18.10	21.25	4.30	0.312	0.343x0.345	0.706	0.829	0.168

**Product No.: C0952**

**Material:** PA  
**Color:** Black  
**Position:** Seat, armrest, fender, headlight, rear bumper



Product Details

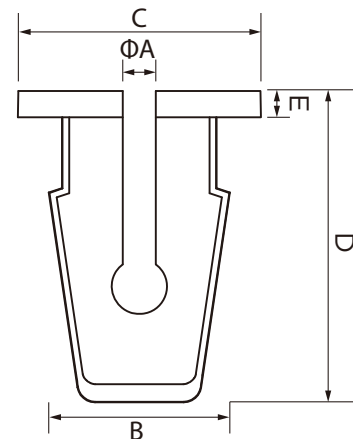

## — SCREW GROMMET & NUT

Part No.	Material	Color	mm					in				
			A	B	C	D	E	A	B	C	D	E
C0945	PA	White	2.85	8.1x6.6	10.90	14.20	1.25	0.111	0.316x0.257	0.425	0.554	0.049
C3184	PA	Natural	3.15	9.0x7.7	9.25x9.5	8.50	1.25	0.123	0.351x0.300	0.361x0.371	0.332	0.049
C3496	PA	Black	3.70	8.9x7.5	10.2x10.0	11.40	1.20	0.144	0.347x0.293	0.398x0.390	0.445	0.047
C3744	PA	Black	3.70	5.8x5.8	8.0x8.0	17.40	1.30	0.144	0.26x0.226	0.312x0.312	0.679	0.051
C0952	PA	Black	3.90	8.1x7.0	12.45x7.2	12.15	1.00	0.152	0.316x0.273	0.486x0.281	0.474	0.039
C1185	POM	Black	4.00	7.4x6.9	13.90	23.10	1.45	0.156	0.289x0.269	0.542	0.901	0.057
C0950	PA	Black	4.10	6.65x8.2	12.20	16.55	1.30	0.160	0.259x0.320	0.476	0.645	0.051
C3253	PA	Black	4.15	6.75x6.0	9.05x9.0	13.65	1.10	0.162	0.263x0.234	0.353x0.351	0.532	0.043
C3026	PA	Light green	4.20	8.15x7.0	9.6x9.65	12.15	0.95	0.164	0.318x0.273	0.374x0.376	0.474	0.037
C1577	PA	Natural	4.30	7.75x9.05	11.25x11.0	12.15	0.80	0.168	0.302x0.353	0.439x0.429	0.474	0.031
C3002	PA	Natural	4.35	11.85x9.65	16.0x13.85	16.10	2.00	0.170	0.462x0.376	0.624x0.540	0.628	0.078
C3893	PA	Black	4.50	11.4x12.7	15.35x13.2	13.75	1.00	0.176	0.445x0.495	0.599x0.515	0.536	0.039
C1786	PA	Beige	5.51	12.1x10.3	12.8x13.0	21.25	1.30	0.215	0.472x0.402	0.441x0.430	0.829	0.051
C1810	PA	Black	5.95	8.55x6.5	11.90	14.20	1.30	0.232	0.333x0.254	0.464	0.554	0.051
C3334	PA	White	6.80	9.6x13.2	13.6x15.65	16.00	3.10	0.265	0.374x0.515	0.530x0.610	0.624	0.121

### Product No.: C3264

**Material:** PA  
**Color:** Brown  
**Position:** Rear bumper, rocker panel



Product Details

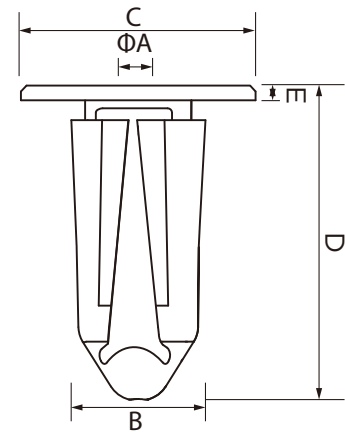

Part No.	Material	Color	mm					in				
			A	B	C	D	E	A	B	C	D	E
C1323	PA	Green	3.00	8.9x9.1	13.8x14.25	20.10	2.55	0.117	0.347x0.355	0.538x0.556	0.784	0.099
C3375	POM	Natural	3.40	9.95x6.0	21.9x8.0	15.90	3.50	0.133	0.388x0.234	0.854x0.312	0.620	0.137
C3183	PA	Natural	3.40	8.0x8.2	14.60	17.95	2.05	0.133	0.312x0.320	0.569	0.700	0.080
C3257	PA	White	3.50	8.85x9.0	15.60	18.20	1.80	0.137	0.345x0.351	0.608	0.710	0.070
C3950	PA	White	3.60	6.85x7.75	9.85x9.85	23.00	0.80	0.140	0.267x0.302	0.384x0.384	0.897	0.031
C3180	PA	Brown	4.10	7.9x7.35	13.70	19.00	3.45	0.160	0.308x0.287	0.534	0.741	0.135
C3264	PA	Brown	4.50	9.15x9.15	16.00	21.40	1.00	0.176	0.357x0.357	0.624	0.835	0.039
C3485	PA	Yellow	4.85	12.2x8.7	18.00	18.20	1.60	0.189	0.476x0.339	0.702	0.710	0.062
C3295	POM	White	5.25	9.3x7.55	12.50	15.60	1.20	0.205	0.363x0.294	0.488	0.608	0.047
C1466	PA	White	5.40	10.2x7.7	14.80	20.10	1.30	0.211	0.398x0.300	0.577	0.784	0.051
C1642	PA	White	5.50	9.9x11.6	19.40	16.70	4.20	0.215	0.386x0.452	0.757	0.651	0.164
C1640	PA	White	5.50	12.2x7.85	13.00	17.10	2.90	0.215	0.476x0.306	0.507	0.667	0.113
C3011	PA	Natural	5.80	9.95x10.15	17.90	25.30	1.65	0.226	0.388x0.396	0.698	0.987	0.064

## SCREW GROMMET & NUT

Part No.	Material	Color	mm					in				
			A	B	C	D	E	A	B	C	D	E
C3006	PA	Blue	6.10	9.9x10.0	15.85	17.00	1.50	0.238	0.386x0.390	0.618	0.663	0.059
C3705	PA	White	7.15	9.25	18.00	16.00	3.00	0.279	0.361	0.702	0.624	0.117
C0359	POM	Black	8.90	14.8x12.7	24.00	23.80	3.00	0.347	0.577x0.495	0.936	0.928	0.117
C0699	POM	Black	8.90	16.0x12.7	24.10	24.00	3.00	0.347	0.624x0.495	0.940	0.936	0.117

### Product No.: C0137

**Material:** PA  
**Color:** Black  
**Position:** Wheelarch, tank cap

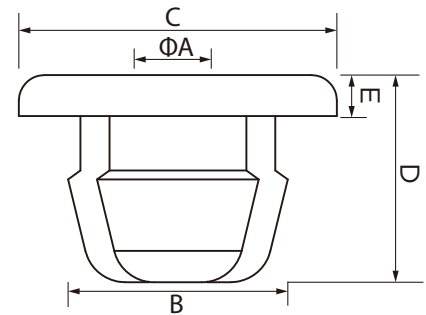

Product Details

Part No.	Material	Color	mm					in				
			A	B	C	D	E	A	B	C	D	E
C0028	PA	White	2.75	8.5x8.5	12.0x12.0	8.80	1.50	0.107	0.332x0.332	0.468x0.468	0.343	0.059
C0027	PA	Beige	3.20	9.5x9.5	13.3x13.3	8.10	0.95	0.125	0.371x0.371	0.519x0.519	0.316	0.037
C0137	PA	Black	3.50	8.5x8.5	12.90	8.90	1.00	0.137	0.332x0.332	0.503	0.347	0.039
C0029	PA	White	3.60	9.1x9.1	11.15x11.15	9.20	1.80	0.140	0.355x0.355	0.435x0.435	0.359	0.070
C3531	PA	Natural	3.60	8.7x8.7	11.2x11.2	8.80	1.60	0.140	0.339x0.339	0.437x0.437	0.343	0.062
C0455	PA	Brown	3.80	8.8x8.8	11.3x11.3	9.00	1.60	0.148	0.343x0.343	0.441x0.441	0.351	0.062
C0030	PA	Beige	4.70	10.65x10.65	15.6x15.6	10.10	2.00	0.183	0.415x0.415	0.608x0.608	0.394	0.078
C0457	PA	Black	5.20	10.5x10.5	15.6x15.6	13.00	1.35	0.203	0.410x0.410	0.612x0.612	0.507	0.053
C0862	PA	White	5.40	9.55x9.55	16.1x16.1	10.60	2.60	0.211	0.372x0.372	0.628x0.628	0.413	0.101
C0652	PA	Green	5.70	10.7x10.7	15.9x15.9	14.55	6.35	0.222	0.417x0.417	0.620x0.620	0.567	0.248
C3908	PA	Natural	6.00	11.65x11.65	16.1x16.1	10.85	3.65	0.234	0.454x0.454	0.628x0.628	0.423	0.142
C0972	PA	White	7.50	10.7x10.7	15.00	9.95	1.40	0.293	0.417x0.417	0.585	0.388	0.055
C0108	POM	Black	12.05	13.0x15.65	25.85x21.6	10.20	2.75	0.470	0.507x0.610	1.008x0.842	0.398	0.107



## — SCREW GROMMET & NUT

**Product No.:** C1777

**Material:** PA  
**Color:** Black  
**Position:** Rear bumper



Product Details

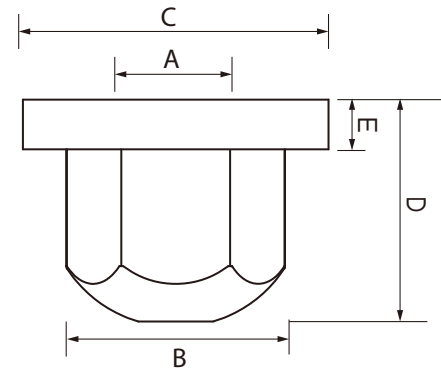

Part No.	Material	Color	mm					in				
			A	B	C	D	E	A	B	C	D	E
C0362	POM	Black	3.20	10.00	12.15	11.35	1.10	0.125	0.390	0.474	0.443	0.043
C3631	PA	Black	3.45	9.1x12.2	12.20	11.95	2.20	0.135	0.355x0.476	0.476	0.466	0.086
C0963	PA	Black	3.60	8.8x9.9	14.10	10.25	2.50	0.140	0.343x0.386	0.550	0.400	0.098
C1872	PA	Natural	3.90	9.8x11.1	21.95	11.15	2.35	0.152	0.382x0.433	0.856	0.435	0.092
C1590	POM	Black	4.10	9.80	24.15	10.30	2.20	0.160	0.382	0.942	0.402	0.086
C1759	PA	Black	4.15	9.7x11.0	15.80	9.85	2.20	0.162	0.378x0.429	0.616	0.384	0.086
C3243	PA	Black	4.30	9.90	18.30	11.10	2.90	0.168	0.386	0.714	0.433	0.113
C3256	PA	Black	4.40	10.00	18.10	10.60	2.40	0.172	0.390	0.706	0.413	0.094
C3240	PA	Black	4.45	10.10	22.00	10.30	2.50	0.174	0.394	0.858	0.402	0.098
C0933	PA	Black	4.60	9.9x11.3	18.45	10.45	2.10	0.179	0.386x0.441	0.720	0.408	0.082
C3433	POM	Black	5.00	9.7x12.95	29.80	11.90	1.85	0.195	0.378x0.505	1.162	0.464	0.072
C3599	PA	Black	5.00	11.5x10.05	19.85	15.40	3.10	0.195	0.449x0.392	0.774	0.601	0.121
C3193	POM	Black	5.10	9.80	30.00	16.20	1.70	0.199	0.382	1.170	0.632	0.066
C3349	PA	Natural	5.10	10.0x11.35	20.25	13.60	2.70	0.199	0.390x0.443	0.790	0.530	0.105
C1777	PA	Black	5.25	9.8x10.6	16.20	11.25	2.90	0.205	0.382x0.413	0.632	0.439	0.113
C3720	PA	Black	5.60	9.90	30.00	15.00	3.00	0.218	0.386	1.170	0.585	0.117
C3749	POM	Black	5.80	9.8x9.8	16.15	9.90	2.10	0.226	0.382x0.382	0.630	0.386	0.082
C3894	PA	Black	6.20	7.90	19.80	9.70	1.50	0.242	0.308	0.772	0.378	0.059
C3519	PA	Black	6.30	14.0x15.9	24.85	15.00	2.05	0.246	0.546x0.620	0.969	0.585	0.080
C1587	POM	Black	8.20	11.50	17.85	9.90	4.25	0.320	0.449	0.696	0.386	0.166
C0930	PA	Black	8.70	9.8x11.1	16.10	11.10	3.20	0.339	0.382x0.433	0.628	0.433	0.125
C1122	PA	Black	9.10	9.7x11.0	16.00	12.90	5.20	0.355	0.378x0.429	0.624	0.503	0.203
C3611	PA	Natural	9.20	9.90	14.90	17.30	8.80	0.359	0.386	0.581	0.675	0.343
C1001	PA	Black	11.10	13.80	28.30	9.00	1.50	0.433	0.538	1.104	0.351	0.059
C1825	PA	Black	11.70	14.25	30.05	10.20	2.05	0.456	0.556	1.172	0.398	0.080
C3529	POM	Black	11.95	13.95	24.75	10.00	2.00	0.466	0.544	0.965	0.390	0.078

## — SCREW GROMMET & NUT

**Product No.:** C3254

**Material:** POM  
**Color:** Black  
**Position:** Emblem



Product Details

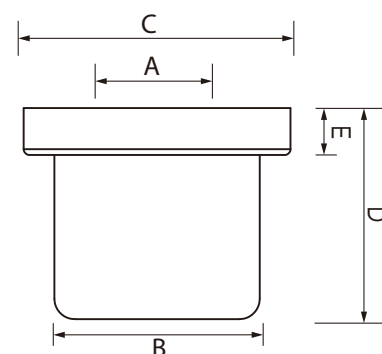

Part No.	Material	Color	mm					in				
			A	B	C	D	E	A	B	C	D	E
C0463	PA	Light yellow	2.70	5.30	6.60	7.25	1.25	0.105	0.207	0.257	0.283	0.049
C3431	PA	Beige	3.50	5.70	6.85	7.15	1.00	0.137	0.222	0.267	0.279	0.039
C3435	PA	Beige	3.90	5.65	6.95	5.10	0.85	0.152	0.220	0.271	0.199	0.033
C0464	PA	Black	4.55	6.50	8.30	7.80	0.95	0.177	0.254	0.324	0.304	0.037
C1392	PA	Black	4.60	10.25x11.2	24.30	10.45	2.25	0.179	0.400x0.437	0.948	0.408	0.088
C3187	PA	Black	4.90	7.40	14.20	7.00	2.05	0.191	0.289	0.554	0.273	0.080
C1387	PA	Black	5.30	10.00	24.20	9.10	2.85	0.207	0.390	0.944	0.355	0.111
C3336	PA	Black	5.30	14.00	20.00	15.00	4.00	0.207	0.546	0.780	0.585	0.156
C3254	PA	Black	5.40	6.95	9.00	7.20	1.50	0.211	0.271	0.351	0.281	0.059
C0967	PA	Black	5.50	10.00	12.80	6.70	1.00	0.215	0.390	0.499	0.261	0.039
C1870	PA	Black	5.50	9.20	40.20	9.10	1.60	0.215	0.359	1.568	0.355	0.062
C3212	PA	Natural	6.00	8.00	12.00	10.20	1.25	0.234	0.312	0.468	0.398	0.049
C3678	PE+PP	Beige	6.00	8.80	14.10	12.25	1.80	0.234	0.343	0.550	0.478	0.070
C3921	PA	Natural	6.10	7.70	14.00	5.00	1.40	0.238	0.300	0.546	0.195	0.055
C3371	PA	Black	6.45	8.80	14.20	9.85	1.40	0.252	0.343	0.554	0.384	0.055
C3419	PA	Natural	7.55	11.40	13.00	10.90	1.50	0.294	0.445	0.507	0.425	0.059
C1628	PA	Black	7.80	9.95	17.20	9.60	1.35	0.304	0.388	0.671	0.374	0.053
C1168	PA	Black	7.95	14.20	22.75	7.90	2.00	0.310	0.554	0.887	0.308	0.078
C3211	PA	Natural	8.00	9.95	14.00	6.50	1.40	0.312	0.388	0.546	0.254	0.055
C1404	PVC	Beige	8.30	13.60	19.80	10.45	2.60	0.324	0.530	0.772	0.408	0.101
C3380	POM	Grey	8.90	22.00	30.55	15.30	2.75	0.347	0.858	1.191	0.597	0.107
C0986	PA	Grey	9.30	7.50	13.15	12.00	1.35	0.363	0.293	0.513	0.468	0.053
C1869	PA	Black	9.30	12.60	30.00	14.55	3.60	0.363	0.491	1.170	0.567	0.140
C3444	POM	Black	10.25	13.10	28.20	7.00	2.00	0.400	0.511	1.100	0.273	0.078
C1096	PA	Black	12.10	15.80	21.80	10.20	1.60	0.472	0.616	0.850	0.398	0.062
C3025	POM	Black	13.00	8.35x15.3	30.10	14.10	2.95	0.507	0.326x0.597	1.174	0.550	0.115
C3356	PA	Black	14.00	16.00	22.00	12.10	1.50	0.546	0.624	0.858	0.472	0.059

## — SCREW GROMMET & NUT

**Product No.: C3404**

**Material:** POM  
**Color:** Black  
**Position:** Fuel tube, front floor



Product Details

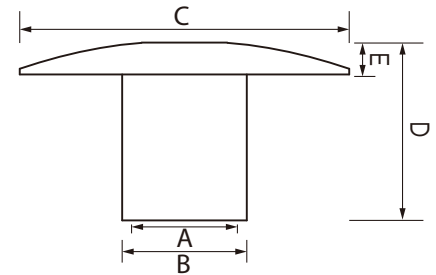

Part No.	Material	Color	mm					in				
			A	B	C	D	E	A	B	C	D	E
C3442	PA	Black	5.25	10.00	29.80	10.10	4.55	0.205	0.390	1.162	0.394	0.177
C1386	PA	Black	5.30	7.80	24.80	12.29	1.89	0.207	0.304	0.967	0.479	0.074
C3466	PA	Black	5.35	7.85	20.30	14.30	2.20	0.209	0.306	0.792	0.558	0.086
C3505	PA	Black	5.50	8.60	15.75	6.85	2.30	0.215	0.335	0.614	0.267	0.090
C3454	PA	Black	5.55	9.35	29.90	20.00	5.00	0.216	0.365	1.166	0.780	0.195
C1842	PA	Black	6.20	8.90	30.00	16.75	5.00	0.242	0.347	1.170	0.653	0.195
C1913	PA	Black	6.20	9.80	29.90	16.70	4.80	0.242	0.382	1.166	0.651	0.187
C3276	PA	Black	6.30	9.50	30.00	19.90	4.75	0.246	0.371	1.170	0.776	0.185
C3929	POM	Black	6.60	10.00	26.90	21.45	2.65	0.257	0.390	1.049	0.837	0.103
C3785	PA	Black	7.10	10.00	25.00	17.70	4.25	0.277	0.390	0.975	0.690	0.166
C0593	PA	Black	7.20	9.40	21.20	13.70	2.40	0.281	0.367	0.827	0.534	0.094
C3404	PA	Black	7.25	9.55	25.30	13.65	2.50	0.283	0.372	0.987	0.532	0.098
C3007	PA	Grey	8.15	9.60	30.05	8.90	5.00	0.318	0.374	1.172	0.347	0.195
C1959	PA	Black	8.85	11.00	30.00	13.40	7.85	0.345	0.429	1.170	0.523	0.306
C1898	PA	Black	9.10	14.6x16.75	25.10	13.65	2.40	0.355	0.569x0.653	0.979	0.532	0.094
C3765	PP	Black	10.7x8.0	21.6x13.65	38.10	16.20	4.75	0.417x0.312	0.842x0.532	1.486	0.632	0.185
C1000	PA	Black	5.6x11.6	14.50	25.25	12.75	2.30	0.218x0.452	0.566	0.985	0.497	0.090
C3219	POM	Milk white	13.95x11.9	15.7x13.7	23.20	10.30	2.30	0.544x0.464	0.612x0.534	0.905	0.402	0.090
C3816	POM	Black	14.5x14.6	21.6x17.1	39.2x30.5	13.15	3.40	0.566x0.569	0.842x0.667	1.529x1.190	0.513	0.133
C3934	PP	Black	21.5x13.6	25.0x24.7	38.10	16.00	4.80	0.839x0.530	0.975x0.963	1.486	0.624	0.187
C4035	PA	Black	16.7x17.0	24.4x19.5	37.1x28.05	12.55	3.30	0.651x0.663	0.952x0.761	1.447x1.094	0.489	0.129
C3689	PP	Black	18.60	22.00	32.10	15.40	2.85	0.725	0.858	1.252	0.601	0.111
C1502	PP	Black	18.63	21.3x15.4	31.90	12.60	2.30	0.727	0.831x0.601	1.244	0.491	0.090

## — SCREW GROMMET & NUT

**Product No.:** C1648

**Material:** PA  
**Color:** Black  
**Position:** Pillar moulding



Product Details

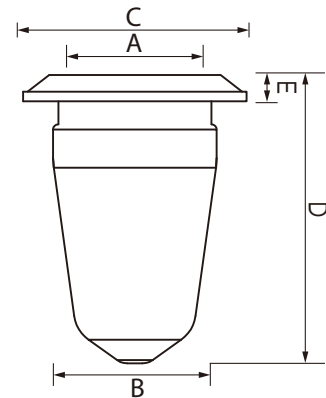

Part No.	Material	Color	mm					in				
			A	B	C	D	E	A	B	C	D	E
C3260	PA	Natural	3.60	5.50	7.05	12.70	0.90	0.140	0.215	0.275	0.495	0.035
C1304	PA	Natural	5.80	8.45	18.00	20.55	2.15	0.226	0.330	0.702	0.801	0.084
C3437	PA	Blue	6.30	7.70	18.10	15.10	1.50	0.246	0.300	0.706	0.589	0.059
C3776	PA	Pink	6.35x4.8	11.8x9.0	16.1x16.0	15.05	1.50	0.248x0.188	0.460x0.351	0.628x0.624	0.587	0.059
C1648	PA	Black	6.60	9.25	12.70	16.35	1.55	0.257	0.361	0.495	0.638	0.060
C1973	TPE	Black	6.60	8.80	16.00	17.00	1.00	0.257	0.343	0.624	0.663	0.039
C0980	PE	Natural	6.90	8.70	16.15	17.65	1.20	0.269	0.339	0.630	0.688	0.047
C3414	TPV	Black	7.15	11.00	13.20	12.00	2.30	0.279	0.429	0.515	0.468	0.090
C0856	PA	Blue	7.20	8.85	12.70	12.30	1.05	0.281	0.345	0.495	0.480	0.041
C0023	PA	Natural	7.25	8.70	15.50	17.80	0.80	0.283	0.339	0.605	0.694	0.031
C3415	PA	Black	8.00	11.00	21.00	13.65	2.00	0.312	0.429	0.819	0.532	0.078
C3952	PA	Black	8.00	6.41	18.05	15.20	1.70	0.312	0.250	0.704	0.593	0.066
C1346-B	TPE	Black	8.50	9.70	18.30	17.60	1.20	0.332	0.378	0.714	0.686	0.047
C3470	PA	Natural	9.05	6.30	17.80	15.65	1.50	0.353	0.246	0.694	0.610	0.059
C1172	PA	Grey	13.50	16.70	18.20	10.95	1.00	0.527	0.651	0.710	0.427	0.039
C1937	POM	Natural	11.0x7.0	11.6x9.2	16.00	14.90	0.80	0.429x0.273	0.452x0.359	0.624	0.581	0.031

**Product No.:** C3280

**Material:** PA  
**Color:** Light green  
**Position:** Rear bumper

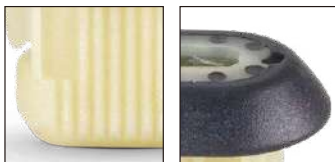

Product Details

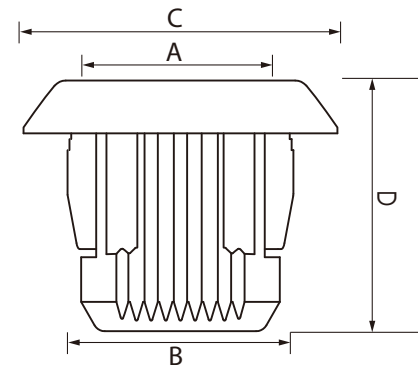

## — SCREW GROMMET & NUT

Part No.	Material	Color	mm				in			
			A	B	C	D	A	B	C	D
C0379	PA	White	13.7x4.0	14.65x8.1	18.9x12.2	18.10	0.534x0.156	0.571x0.316	0.737x0.476	0.706
C0394	PA	White	12.0x4.7	12.65x7.55	16.6x10.0	10.30	0.468x0.183	0.493x0.294	0.647x0.390	0.402
C0470	PA	Beige	12.9x2.8	15.4x6.9	17.2x12.9	9.60	0.503x0.109	0.601x0.269	0.671x0.503	0.374
C0480	PA	Black	9.2x2.8	7.3x11.6	13.5x10.7	9.80	0.359x0.109	0.285x0.452	0.527x0.417	0.382
C0823	PA	Light green	14.3x3.2	16.6x6.5	22.3x13.25	18.80	0.577x0.148	0.644x0.254	0.441x0.515	0.733
C1125	POM	White	29.4x10.65	31.35x14.1	39.0x20.2	25.60	1.147x0.415	1.222x0.550	1.52x0.788	0.998
C1190	PA	White	5.6x7.6	13.9x8.85	18.10	17.30	0.218x0.296	0.542x0.345	0.706	0.675
C1388	PA	Dark grey	8.05x5.7	11.9x9.0	18.0x14.0	15.00	0.314x0.223	0.464x0.355	0.702x0.546	0.585
C1575	PA	Black	5.40	6.85x4.35	9.8x7.7	9.90	0.211	0.267x0.170	0.382x0.300	0.386
C1578	PA	Black	5.1x12.4	13.6x6.6	13.2x20.0	17.10	0.199x0.484	0.530x0.257	0.515x0.780	0.667
C1623	PA	Brown	11.3x5.7	11.7x9.1	19.1x15.35	17.60	0.441x0.222	0.456x0.355	0.745x0.599	0.686
C1646	PA	Black	10.6x5.5	11.7x7.6	22.1x18.1	17.65	0.413x0.215	0.456x0.296	0.862x0.706	0.688
C1755	PA	Grey	11.5x7.5	11.85x9.3	16.0x12.15	11.60	0.449x0.293	0.462x0.363	0.624x0.474	0.452
C3228	PA	Grey	10.55x5.25	12.1x8.0	15.1x10.2	12.85	0.411x0.205	0.472x0.312	0.624x0.476	0.501
C3279	PE	Black	10.0x6.25	13.35x18.7	22.8x19.0	16.85	0.390x0.244	0.521x0.729	0.890x0.729	0.657
C3280	PA	Light green	13.5x3.15	15.4x6.65	21.05x13.75	17.30	0.527x0.123	0.601x0.259	0.821x0.536	0.675
C3300	PA	Light green	11.2x1.9	15.2x6.75	18.0x9.65	10.10	0.437x0.074	0.593x0.263	0.702x0.376	0.394
C3301	PA	Light green	12.45x2.7	19.35x10.3	21.9x13.0	10.75	0.486x0.105	0.755x0.402	0.854x0.507	0.419
C3333	POM	Grey	16.8x4.9	22.0x16.35	33.45x23.95	37.15	0.655x0.191	0.858x0.638	1.305x0.934	1.449
C3420	PA	Natural	11.1x2.6	15.2x6.3	19.0x10.1	13.30	0.433x0.101	0.593x0.246	0.741x0.394	0.519
C3780	PA	Light grey	11.4x6.45	11.7x8.55	18.0x15.0	15.30	0.445x0.252	0.456x0.333	0.702x0.585	0.597
C3874	PA	Black	10.4x6.2	11.8x7.8	15.6x9.0	9.70	0.406x0.242	0.460x0.304	0.608x0.351	0.378
C3911	PA	White	17.35x7.5	18.5x8.1	19.95x13.25	9.45	0.676x0.293	0.722x0.316	0.778x0.517	0.369
C3918	PP	Natural	15.0x6.2	15.0x6.2	19.2x10.1	16.05	0.585x0.242	0.585x0.242	0.749x0.394	0.626
C3954	PA	Black	7.3x5.95	14.3x9.2	18.00	17.10	0.285x0.232	0.558x0.359	0.702	0.667

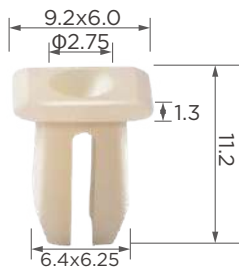

C0024

**Material:** PA  
**Color:** White  
**Moulding, front end**



C0025

**Material:** PA  
**Color:** Beige  
**Tail lamp, door panel**



C0026

**Material:** PA  
**Color:** Beige  
**Headlight, door panel**

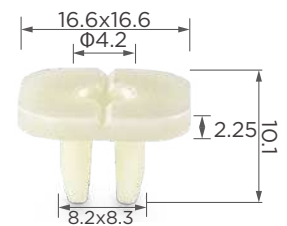

C0032

**Material:** PA  
**Color:** White  
**Door panel, liftgate**



# SCREW GROMMET & NUT

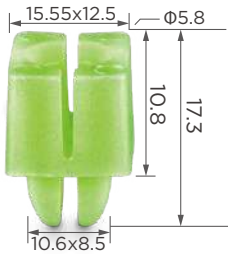

C0057

**Material:** PA  
**Color:** Green  
**Door panel**

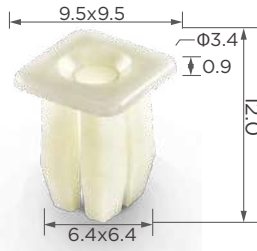

C0106

**Material:** PA  
**Color:** White  
**Screw grommet**



C0126

**Material:** PA  
**Color:** Black  
**Door panel**

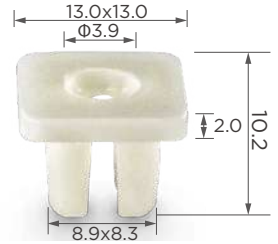

C0129

**Material:** PA  
**Color:** White  
**Door panel**

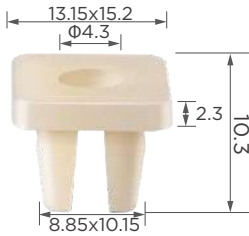

C0130

**Material:** PA  
**Color:** White  
**Screw grommet**



C0134

**Material:** PA  
**Color:** White  
**Headlight, grille**

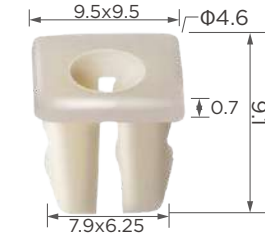

C0177

**Material:** PA  
**Color:** White  
**Headlight**



C0179

**Material:** PA  
**Color:** White  
**Screw grommet**

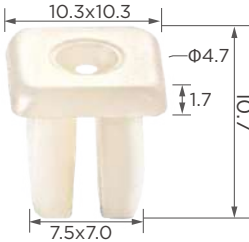

C0180

**Material:** PA  
**Color:** White  
**Radiator, grille**

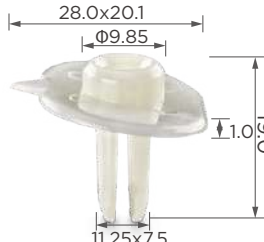

C0222

**Material:** PA  
**Color:** White  
**Rear bumper**



C0265

**Material:** PA  
**Color:** Beige  
**Headlight**



C0269

**Material:** PA  
**Color:** White  
**Rear panel**



C0292

**Material:** PA  
**Color:** Beige  
**Front and rear bumper**



C0313

**Material:** PA  
**Color:** White  
**License plate**



C0317

**Material:** PA  
**Color:** White  
**Rear panel locking**



C0387

**Material:** PA  
**Color:** Beige  
**Screw grommet**



C0398

**Material:** PA  
**Color:** Black  
**Air vent**

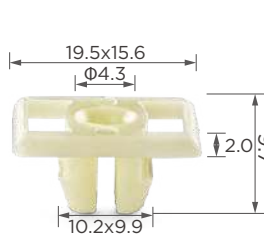

C0421

**Material:** PA  
**Color:** Beige  
**Rear panel**

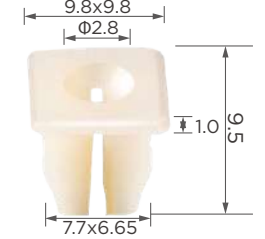

C0430

**Material:** PA  
**Color:** White  
**License plate**

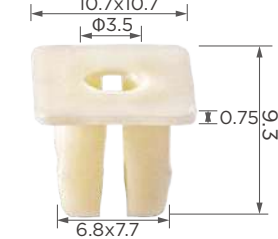

C0433

**Material:** PA  
**Color:** Beige  
**Grille, splash shield, door panel, seat belt, antenna**

## — SCREW GROMMET & NUT

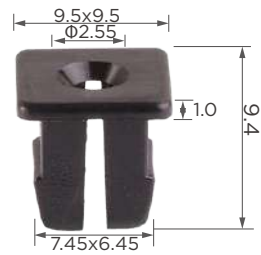

C0466

**Material:** PA  
**Color:** Black  
**Screw grommet**



C0571

**Material:** PA  
**Color:** Black/ White  
**Rocker panel, door panel**



C0900

**Material:** PA  
**Color:** White  
**Screw grommet**

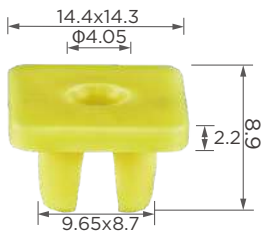

C1228

**Material:** PA  
**Color:** Yellow  
**Screw grommet**

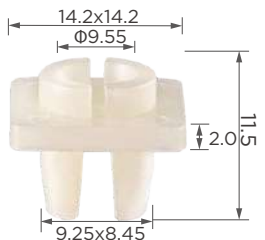

C1390

**Material:** PA  
**Color:** White  
**Front bumper, door panel**

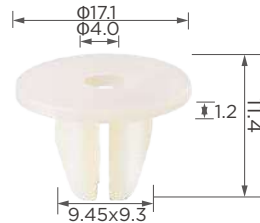

C0481

**Material:** PA  
**Color:** White  
**Front bumper, front end, splash guard**



C0832

**Material:** PA  
**Color:** White  
**Screw grommet**



C0971

**Material:** PA  
**Color:** Black  
**Rear bumper, wheelarch, splash guard**



C1229

**Material:** POM  
**Color:** White  
**Screw grommet**

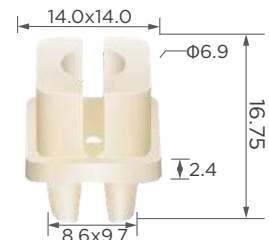

C1391

**Material:** PA  
**Color:** White  
**Door panel, door handle**



C0504

**Material:** PA  
**Color:** Blue  
**Wheelarch, rear bumper**



C0839

**Material:** PA  
**Color:** Black  
**Rocker panel, body**

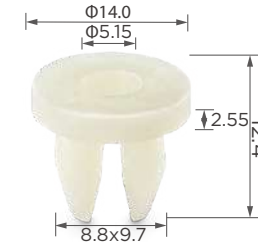

C1005

**Material:** PA  
**Color:** White  
**Dashboard**



C1340

**Material:** PA  
**Color:** White  
**Splash guard, front bumper, front end**

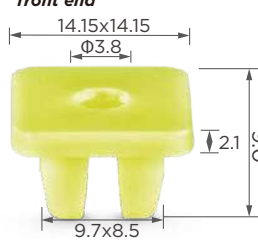

C1451

**Material:** PA  
**Color:** White  
**Pillar garnish, rear tray**

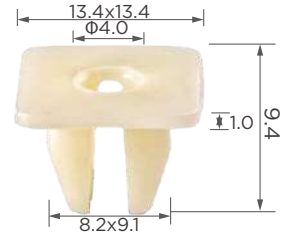

C0553

**Material:** PA  
**Color:** Beige  
**Fender, rocker panel, frog lamp, floor attachment**



C0860

**Material:** PA  
**Color:** White  
**Front bumper**

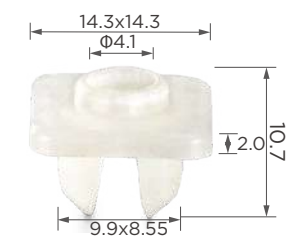

C1006

**Material:** PA  
**Color:** White  
**Rear panel**



C1350

**Material:** PA  
**Color:** White  
**Splash guard**



C1454

**Material:** PA  
**Color:** Natural  
**Screw grommet**

# — SCREW GROMMET & NUT



C1455

**Material:** PA  
**Color:** Natural  
**Door panel**

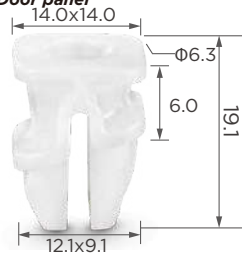

C1529

**Material:** PA  
**Color:** White  
**Door panel**

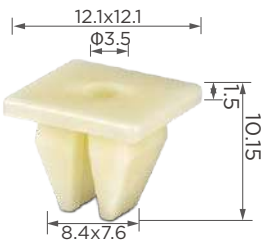

C1783

**Material:** PA  
**Color:** Beige  
**Front bumper, tank filler cap**

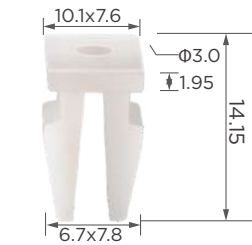

C1920

**Material:** PA  
**Color:** Natural  
**Front bumper, fender**

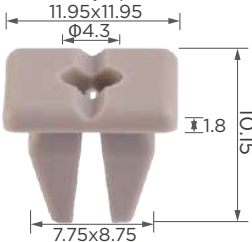

C3048

**Material:** PA  
**Color:** Grey  
**Front bumper, wheelarch**

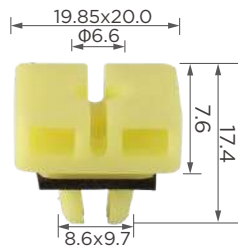

C1462

**Material:** PA  
**Color:** Yellow  
**Rocker panel**

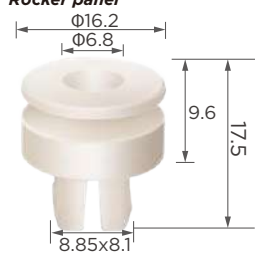

C1530

**Material:** PA  
**Color:** Natural  
**Quarter panel**



C1826

**Material:** PA  
**Color:** Black  
**Front bumper, rocker panel**

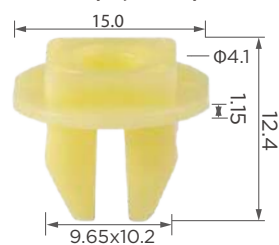

C1943

**Material:** POM  
**Color:** Yellow  
**Rear bumper**



C3051

**Material:** PA  
**Color:** Natural  
**Door panel, rear panel**



C1465

**Material:** PA  
**Color:** White  
**Pillar garnish**



C1562

**Material:** PA  
**Color:** Natural  
**License plate**



C1829

**Material:** PA  
**Color:** Black  
**Wiper system**



C1968

**Material:** PA  
**Color:** Natural  
**Rear bumper, wheelarch**



C3054

**Material:** PA  
**Color:** Black  
**Wheelarch**



C1471

**Material:** PA  
**Color:** Natural  
**Door panel**

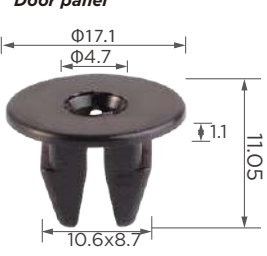

C1609

**Material:** PA  
**Color:** Black  
**Rocker panel**



C1866

**Material:** PA  
**Color:** Natural  
**Door panel, rear bumper**

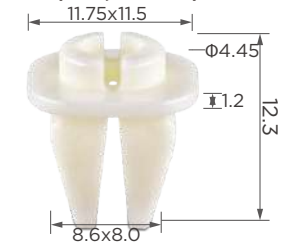

C3035

**Material:** PA  
**Color:** White  
**Front bumper**

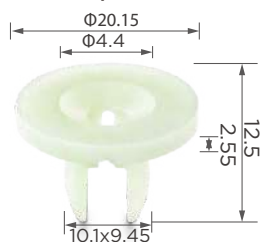

C3067

**Material:** PA  
**Color:** Light green  
**Wheelarch**

# — SCREW GROMMET & NUT



**C3319**

**Material:** PA  
**Color:** Natural  
**Front bumper**



**C3402**

**Material:** PA  
**Color:** Natural  
**Screw grommet**



**C3406**

**Material:** PA  
**Color:** Natural  
**Screw grommet**



**C3492**

**Material:** PA  
**Color:** Pink red  
**Door panel, rear tray**



**C3517**

**Material:** PA  
**Color:** Black  
**Screw grommet**



**C3530**

**Material:** PA  
**Color:** Dark grey  
**Door panel**



**C3574**

**Material:** PA  
**Color:** Natural  
**Splash guard**

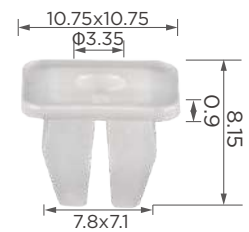

**C3642**

**Material:** PA  
**Color:** Natural  
**Side moulding**



**C3679**

**Material:** PA  
**Color:** Beige  
**Door panel, rear tray, pillar**

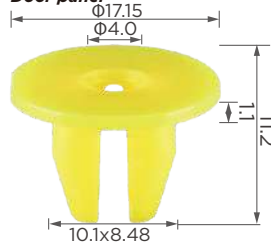

**C3743**

**Material:** PA  
**Color:** Yellow  
**Rocker panel, wheelarch fender liner, front heat shield**

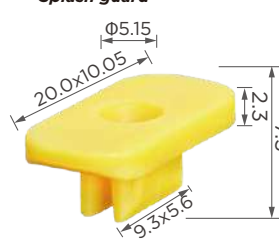

**C3819**

**Material:** PA  
**Color:** Yellow  
**Upper trim**



**C3842**

**Material:** PA  
**Color:** Light green  
**Tailgate, dashboard, glove box, cowl, engine belly pan**

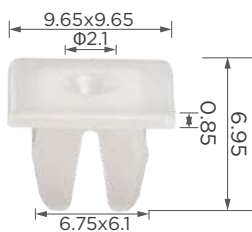

**C3869**

**Material:** PA  
**Color:** White  
**Rocker panel**

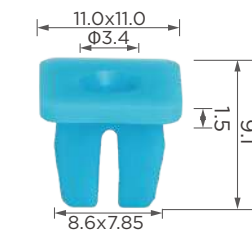

**C3888**

**Material:** PA  
**Color:** Blue  
**Trunk lid**



**C3907**

**Material:** PA  
**Color:** White  
**License plate**



# SCREW GROMMET & NUT



**C0031**

**Material:** PA  
**Color:** Black  
**Splash guard, wheelarch**



**C0230**

**Material:** PA  
**Color:** Black  
**Front bumper, front end, rocker panel, splash guard**



**C0344**

**Material:** PA  
**Color:** Black  
**Rear bumper, fender**



**C0630**

**Material:** PA  
**Color:** Black  
**Rocker panel, fender, splash guard**



**C0664**

**Material:** PA  
**Color:** Black  
**Rocker panel, splash guard**



**C1266**

**Material:** PA  
**Color:** Yellow  
**Rocker panel**



**C1389**

**Material:** PA  
**Color:** Dark Grey  
**Rear bumper**



**C1602**

**Material:** PA  
**Color:** Black  
**Front bumper, splash guard, rocker panel**



**C1917**

**Material:** PA  
**Color:** Black  
**Front end, wheelarch**



**C1931**

**Material:** PA  
**Color:** Black  
**Rocker panel, rear bumper**



**C3008**

**Material:** PA  
**Color:** Black  
**Wheelarch**



**C3769**

**Material:** PA  
**Color:** Black  
**Rocker panel, wheelarch fender liner, front heat shield**



**C3796**

**Material:** PA  
**Color:** Black  
**Front bumper, side molding, rocker panel**



**C3899**

**Material:** PA  
**Color:** Black  
**Fender liner, fuel tank**



**C3903**

**Material:** PA  
**Color:** Black  
**Fender liner**





# — SCREW GROMMET & NUT

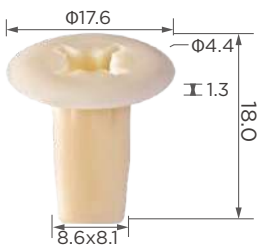

C0033

**Material:** PA  
**Color:** Beige  
**Fender**



C0075

**Material:** PA  
**Color:** Beige  
**Carpet, rear bumper, rear shield, door panel, wiper**



C0287

**Material:** PA  
**Color:** Bluish White  
**Wheelarch**



C0383

**Material:** PA  
**Color:** White  
**Cowl**



C0486

**Material:** PA  
**Color:** White  
**Door panel**



C0034

**Material:** PA  
**Color:** Beige  
**Floor attachment, door panel**



C0157

**Material:** PA  
**Color:** Beige  
**Dashboard, armrest**



C0293

**Material:** PA  
**Color:** White  
**Rear body, pillar garnish**



C0389

**Material:** PA  
**Color:** White  
**Screw grommet**



C0809

**Material:** PA  
**Color:** White  
**Cowl**



C0073

**Material:** PA  
**Color:** Beige  
**Rear window, pillar garnish**



C0267

**Material:** PA  
**Color:** White  
**Screw grommet**



C0370

**Material:** PA  
**Color:** White  
**Rear bumper, rear panel**



C0482

**Material:** PA  
**Color:** Beige  
**Wheelarch, fender**



C0817

**Material:** PA  
**Color:** Yellow  
**Roof, rear panel, rear bumper, floor attachment**



C0074

**Material:** PA  
**Color:** Beige  
**Pillar garnish**



C0286

**Material:** PA  
**Color:** White  
**Screw grommet**



C0381

**Material:** PA  
**Color:** White  
**Door panel**



C0483

**Material:** PA  
**Color:** White  
**Rear panel, door panel, speaker**



C0954

**Material:** PA  
**Color:** White  
**Door panel**

# SCREW GROMMET & NUT



**C0976**

**Material:** PA  
**Color:** White  
**Screw grommet**



**C0996**

**Material:** PA  
**Color:** White  
**Rear bumper**



**C1289**

**Material:** PA  
**Color:** Beige  
**Screw grommet**

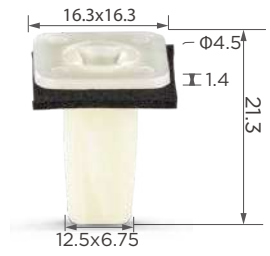

**C1341**

**Material:** PA  
**Color:** White  
**Screw grommet**



**C1384**

**Material:** PA  
**Color:** White  
**Rear bumper**



**C1385**

**Material:** PA  
**Color:** White  
**Floor attachment, wheelarch**



**C1467**

**Material:** PA  
**Color:** White  
**Front and rear bumper**



**C1521**

**Material:** PA  
**Color:** White  
**Rear bumper, rear window**



**C1522**

**Material:** PA  
**Color:** White  
**Wheelarch, floor attachment, grille, front bumper**



**C1665**

**Material:** PA  
**Color:** White  
**Door panel**



**C1690**

**Material:** PA  
**Color:** Natural  
**Screw grommet**



**C1738**

**Material:** PA  
**Color:** Natural  
**Rear bumper, taillamp, cowl, rear tray**



**C1784**

**Material:** PA  
**Color:** White  
**Tube, Rocker panel**



**C1915**

**Material:** PA  
**Color:** Natural  
**Door panel, rear tray**



**C1986**

**Material:** PA  
**Color:** Natural  
**Front bumper, rocker panel**



**C3012**

**Material:** PA  
**Color:** Natural  
**Front and rear bumper**



**C3024**

**Material:** PA  
**Color:** Natural  
**Front and rear bumper**



**C3036**

**Material:** PA  
**Color:** Natural  
**Front bumper, fender**



**C3038**

**Material:** PA  
**Color:** Natural  
**Rear bumper**



**C3216**

**Material:** PA  
**Color:** Yellow  
**Front and rear bumper**

# — SCREW GROMMET & NUT



C3218

**Material:** PA  
**Color:** Natural  
**Rear panel**



C3231

**Material:** PA  
**Color:** Natural  
**Rear bumper**



C3250

**Material:** PA  
**Color:** Natural  
**Rear bumper**



C3262

**Material:** PA  
**Color:** Grey  
**Floor attachment, roof, tube**

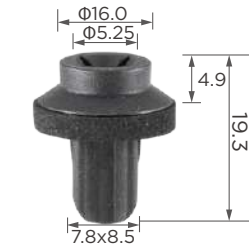

C3374

**Material:** PA  
**Color:** Black  
**Rear panel door attachment**

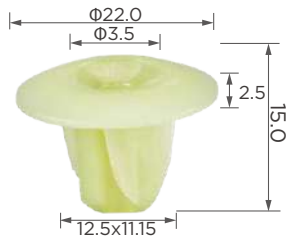

C3423

**Material:** PA  
**Color:** Light green  
**Splash guard**



C3443

**Material:** PA  
**Color:** Light green  
**Window seal**



C3476

**Material:** PA  
**Color:** Natural  
**Rear panel, dashboard**



C3508

**Material:** PA  
**Color:** Natural  
**Headlight**



C3556

**Material:** PA  
**Color:** Natural  
**Screw grommet**



C3560

**Material:** PA  
**Color:** Light green  
**Door panel**



C3621

**Material:** PA  
**Color:** Beige  
**Rear license plate**



C3701

**Material:** PA  
**Color:** Natural  
**Wheelarch, fender liner**



C3721

**Material:** PA  
**Color:** Dark grey  
**Tailgate, rear quarter panel**



C3753

**Material:** PA  
**Color:** Natural  
**Door panel, wheelarch fender linder, rear door panel**



C3793

**Material:** PA  
**Color:** Beige  
**Fender liner, cowl, under shield**



C3930

**Material:** PA  
**Color:** Black  
**Rear bumper, pad monitor, speaker**



C3951

**Material:** PA  
**Color:** Beige  
**License plate, liftgate applique**



C4032

**Material:** PA  
**Color:** Natural  
**Rear interior panel, side molding, door panel**

# — SCREW GROMMET & NUT

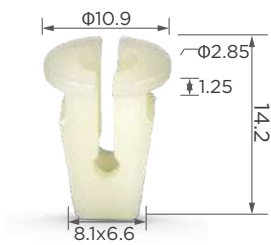

**C0945**

**Material:** PA  
**Color:** White  
**Headlight, rear panel, license plate**



**C1577**

**Material:** PA  
**Color:** Natural  
**Screw grommet**



**C3026**

**Material:** PA  
**Color:** Light green  
**Door panel, seat belt, speaker system**



**C3496**

**Material:** PA  
**Color:** Black  
**Screw grommet**



**C0950**

**Material:** PA  
**Color:** Black  
**Fender flare, floor attachment, front and rear bumper, wheelarch, splash guard, pillar guard**



**C1786**

**Material:** PA  
**Color:** Beige  
**Screw grommet**



**C3184**

**Material:** PA  
**Color:** Natural  
**Windshield, hood, rocker panel**



**C3744**

**Material:** PA  
**Color:** Black  
**Rocker panel, pillar, fender flare**

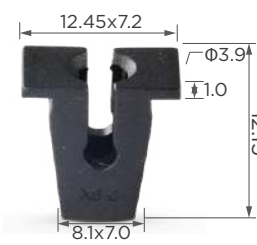

**C0952**

**Material:** PA  
**Color:** Black  
**Seat, armrest, fender, headlight, rear bumper**



**C1810**

**Material:** PA  
**Color:** Black  
**Fender, seat**



**C3253**

**Material:** PA  
**Color:** Black  
**Rear panel**

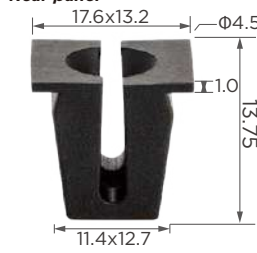

**C3893**

**Material:** PA  
**Color:** Black  
**Headlight, grille**



**C1185**

**Material:** POM  
**Color:** Black  
**Screw grommet**



**C3002**

**Material:** PA  
**Color:** Natural  
**Screw grommet**



**C3334**

**Material:** PA  
**Color:** White  
**Bracket**

# — SCREW GROMMET & NUT



C0359

**Material:** POM  
**Color:** Black  
**Front bumper**



C0699

**Material:** POM  
**Color:** Black  
**Front bumper**



C1323

**Material:** PA  
**Color:** Green  
**Screw grommet**



C1466

**Material:** PA  
**Color:** White  
**Side moulding**



C1640

**Material:** PA  
**Color:** White  
**Rear panel**



C1642

**Material:** PA  
**Color:** White  
**Rear bumper, wheelarch, rear tray**

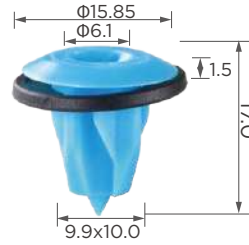

C3006

**Material:** PA  
**Color:** Blue  
**Exterior mirror, brake**



C3011

**Material:** PA  
**Color:** Natural  
**Screw grommet**

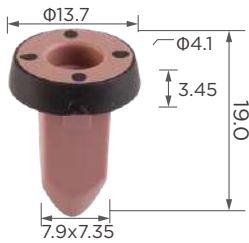

C3180

**Material:** PA  
**Color:** Brown  
**Rear bumper, door panel, wheelarch**



C3183

**Material:** PA  
**Color:** Natural  
**Rocker panel, fender, floor attachment**



C3257

**Material:** PA  
**Color:** White  
**Rear bumper, pillar garnish, rear tray**

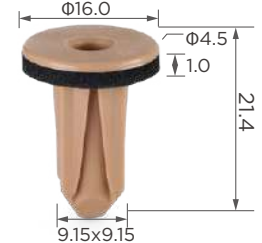

C3264

**Material:** PA  
**Color:** Brown  
**Rear bumper, rocker panel**



C3295

**Material:** POM  
**Color:** White  
**Sound insulating**



C3375

**Material:** POM  
**Color:** Natural  
**Front door window**



C3485

**Material:** PA  
**Color:** Yellow  
**Rear bumper**



C3705

**Material:** PA  
**Color:** White  
**Rear fender, grille**



## — SCREW GROMMET & NUT

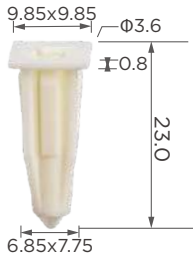

C3950

**Material:** PA  
**Color:** White  
*Rear bumper, fender liner*

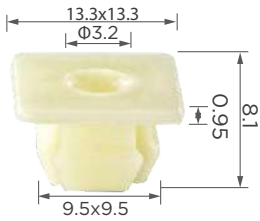

C0027

**Material:** PA  
**Color:** Beige  
*Screw grommet*

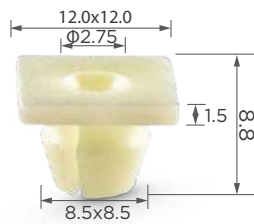

C0028

**Material:** PA  
**Color:** White  
*Headlight, grille*

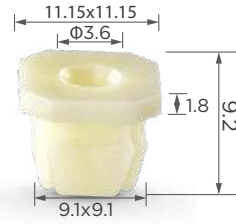

C0029

**Material:** PA  
**Color:** White  
*Screw grommet*

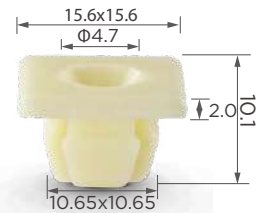

C0030

**Material:** PA  
**Color:** Beige  
*Rear bumper, engine*



C0108

**Material:** POM  
**Color:** Black  
*Grille*



C0137

**Material:** PA  
**Color:** Black  
*Wheelarchm, tank cap*

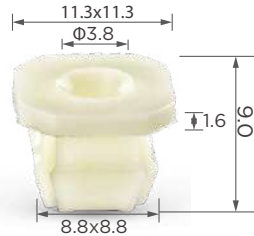

C0455

**Material:** PA  
**Color:** Beige  
*Screw grommet*



C0457

**Material:** PA  
**Color:** Black  
*Front bumper*

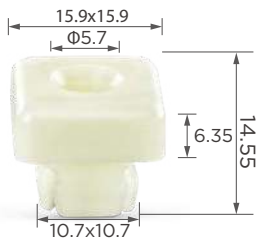

C0652

**Material:** PA  
**Color:** Green  
*Door panel, rear shield*

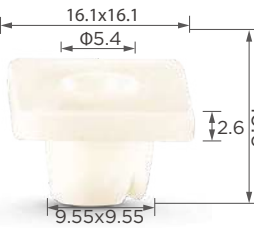

C0862

**Material:** PA  
**Color:** White  
*Front bumper, license*



C0972

**Material:** PA  
**Color:** White  
*Headlight*



C3531

**Material:** PA  
**Color:** Natural  
*Headlight, grille*

# — SCREW GROMMET & NUT



C3908

**Material:** PA  
**Color:** Natural  
**Front lamp**



C0362

**Material:** POM  
**Color:** Black  
**Hood, door panel, side protector**



C0930

**Material:** PA  
**Color:** Black  
**Hydro steering, rocker panel, splash guard**



C0933

**Material:** PA  
**Color:** Black  
**Fuel pump**



C0963

**Material:** PA  
**Color:** Black  
**Nut**



C1001

**Material:** PA  
**Color:** Black  
**Front floor, engine cover**



C1122

**Material:** PA  
**Color:** Black  
**Nut**



C1587

**Material:** POM  
**Color:** Black  
**Front bumper, splash guard**



C1590

**Material:** POM  
**Color:** Black  
**Fuel pump, wheelarch, fender, rear bumper, radiator**



C1759

**Material:** PA  
**Color:** Black  
**Wheelarch, fuel tube, front bumper, splash guard**



C1777

**Material:** PA  
**Color:** Black  
**Rear bumper**



C1825

**Material:** PA  
**Color:** Black  
**Rear bumper, splash guard**



C1872

**Material:** PA  
**Color:** Black  
**Wiper washer, headlight cleaning, sound insulation**

# SCREW GROMMET & NUT

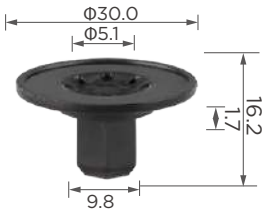

**C3193**  
**Material:** POM  
**Color:** Black  
*Floor, rear bumper, sound insulation*



**C3240**  
**Material:** PA  
**Color:** Black  
*Wheelarch, side panel*

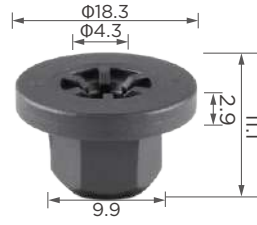

**C3243**  
**Material:** PA  
**Color:** Black  
*Seat, glovebox*



**C3256**  
**Material:** PA  
**Color:** Black  
*Wheelarch, floor, heat radiator*



**C3349**  
**Material:** PA  
**Color:** Natural  
*Floor, fuel tube*



**C3433**  
**Material:** POM  
**Color:** Black  
*Fuel tube, front floor*



**C3519**  
**Material:** PA  
**Color:** Black  
*Nut*



**C3529**  
**Material:** POM  
**Color:** Black  
*Heat insulation*



**C3599**  
**Material:** PA  
**Color:** Black  
*Cowl, wheelarch*



**C3611**  
**Material:** PA  
**Color:** Natural  
*Nut*



**C3631**  
**Material:** PA  
**Color:** Black  
*Side moulding*



**C3720**  
**Material:** PA  
**Color:** Black  
*Wheelarch, fender liner*



**C3749**  
**Material:** POM  
**Color:** Black  
*Wheelarch fender liner, front quarter panel*



**C3866**  
**Material:** POM  
**Color:** Grey  
*Fender liner*

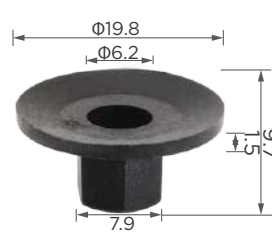

**C3894**  
**Material:** PA  
**Color:** Black  
*Fender liner, door panel, air duct*



# SCREW GROMMET & NUT



**C0463**

**Material:** PA  
**Color:** Light yellow  
**Tubular nut**



**C0464**

**Material:** PA  
**Color:** Black  
**Tubular nut**



**C0967**

**Material:** PA  
**Color:** Black  
**Side moulding**



**C0986**

**Material:** PA  
**Color:** Grey  
**Rear pillar moulding**



**C1096**

**Material:** PA  
**Color:** Black  
**Side panel, wheelarch, heat radiator**



**C1168**

**Material:** PA  
**Color:** Black  
**Engine cover**



**C1387**

**Material:** PA  
**Color:** Black  
**Floor**



**C1392**

**Material:** PA  
**Color:** Black  
**Front floor, fender, inside**



**C1404**

**Material:** PVC  
**Color:** Beige  
**Nut**



**C1628**

**Material:** PA  
**Color:** Black  
**Nut**



**C1869**

**Material:** PA  
**Color:** Black  
**Floor, carpet, mat**



**C1870**

**Material:** PA  
**Color:** Black  
**Floor, mat, cap lower**



**C3025**

**Material:** POM  
**Color:** Black  
**Wheelarch, heat radiator, carpet**



**C3187**

**Material:** PA  
**Color:** Black  
**Grille, side moulding**



**C3211**

**Material:** PA  
**Color:** Natural  
**Nut**



**C3212**

**Material:** PA  
**Color:** Natural  
**Nut**



**C3254**

**Material:** PA  
**Color:** Black  
**Emblem**



**C3336**

**Material:** PA  
**Color:** Black  
**Nut**



**C3356**

**Material:** PA  
**Color:** Black  
**Nut**



**C3371**

**Material:** PA  
**Color:** Black  
**Front bumper**

## SCREW GROMMET & NUT



C3380

**Material:** POM  
**Color:** Grey  
*Side moulding, rocker panel*



C3419

**Material:** PA  
**Color:** Natural  
*Headlight*



C3431

**Material:** PA  
**Color:** Beige  
*Liftgate, emblem*



C3435

**Material:** PA  
**Color:** Beige  
*Emblem*



C3444

**Material:** POM  
**Color:** Black  
*Rear bumper, rear panel*

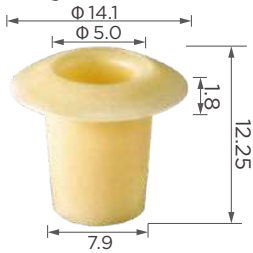

C3678

**Material:** PE+PP  
**Color:** Beige  
*Rocker panel, pillar, foot mat, speaker, rear tray*



C3921

**Material:** PA  
**Color:** Natural  
*Clip*

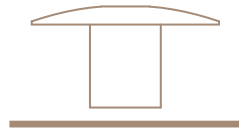

C0593

**Material:** PA  
**Color:** Black  
*Side moulding, cowl*



C1000

**Material:** PA  
**Color:** Black  
*Splash guard*



C1386

**Material:** PA  
**Color:** Black  
*Floor*



C1502

**Material:** PP  
**Color:** Black  
*Rocker panel*



C1842

**Material:** PA  
**Color:** Black  
*Floor, carpet, mat, wheelarch*



C1898

**Material:** PA  
**Color:** Black  
*Rocker panel, splash panel*



C1913

**Material:** PP  
**Color:** Black  
*Carpet, mat, wheelarch*



C1959

**Material:** PA  
**Color:** Black  
*Wheelarch, front bumper*



# — SCREW GROMMET & NUT

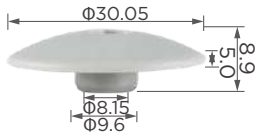

**C3007**  
**Material:** PA  
**Color:** Grey  
*Sound insulation, rear tray*



**C3219**  
**Material:** POM  
**Color:** Milk white  
*Side moulding*



**C3276**  
**Material:** PA  
**Color:** Black  
*Door panel, water radiator, mat, carpet*



**C3404**  
**Material:** PA  
**Color:** Black  
*Cowl, rear mirror*



**C3442**  
**Material:** PA  
**Color:** Black  
*Carpet, floor, insulator, wheelarch, inside body*



**C3454**  
**Material:** PA  
**Color:** Black  
*Carpet, rear tray*



**C3466**  
**Material:** PA  
**Color:** Black  
*Pillar, rear tray*



**C3505**  
**Material:** PA  
**Color:** Black  
*Rear panel*



**C3689**  
**Material:** PP  
**Color:** Black  
*Rocker panel, side molding*



**C3765**  
**Material:** PP  
**Color:** Black  
*Rocker panel*

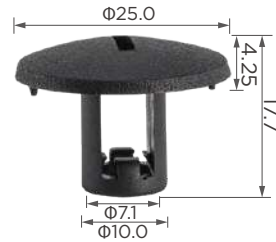

**C3785**  
**Material:** PA  
**Color:** Black  
*Carpet*



**C3816**  
**Material:** PA  
**Color:** Black  
*Front bumper, side molding, rocker panel*



**C3929**  
**Material:** POM  
**Color:** Black  
*Rear trunk trim*



**C3934**  
**Material:** PP  
**Color:** Black  
*Rocker panel*



**C4035**  
**Material:** PA  
**Color:** Black  
*Rocker panel cover cap*



# SCREW GROMMET & NUT



**C0023**

**Material:** PA  
**Color:** Natural  
**Door panel**



**C0856**

**Material:** PA  
**Color:** Blue  
**Roof, side moulding**



**C0980**

**Material:** PA  
**Color:** Natural  
**Roof**



**C1172**

**Material:** PA  
**Color:** Grey  
**Nut**



**C1304**

**Material:** PA  
**Color:** Natural  
**Nut**



**C1346B**

**Material:** TPE  
**Color:** Black  
**Nut**



**C1648**

**Material:** PA  
**Color:** Black  
**Pillar moulding**



**C1937**

**Material:** POM  
**Color:** Natural  
**Tail light**



**C1973**

**Material:** TPE  
**Color:** Black  
**Rocker panel, sill**



**C3260**

**Material:** PA  
**Color:** Natural  
**Liftgate**



**C3414**

**Material:** TPV  
**Color:** Black  
**Nut**



**C3415**

**Material:** POM  
**Color:** Black  
**Nut**



**C3437**

**Material:** PA  
**Color:** Blue  
**Tail light**



**C3470**

**Material:** PA  
**Color:** Natural  
**Tail light**



**C3776**

**Material:** PA  
**Color:** Pink  
**Headlight frame front end**



**C3952**

**Material:** PA  
**Color:** Black  
**Taillight**

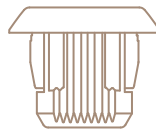

# — SCREW GROMMET & NUT



C0379

**Material:** PA  
**Color:** White  
**Door panel**



C0394

**Material:** PA  
**Color:** White  
**Grille**



C0470

**Material:** PA  
**Color:** Beige  
**Door panel**



C0480

**Material:** PA  
**Color:** Black  
**Cowl**



C0823

**Material:** PA  
**Color:** Light green  
**Rear tray, door panel**



C1125

**Material:** POM  
**Color:** White  
**Nut**



C1190

**Material:** PA  
**Color:** White  
**Nut**



C1388

**Material:** PA  
**Color:** Dark grey  
**Nut**



C1575

**Material:** PA  
**Color:** Black  
**Emblem, side moulding**



C1578

**Material:** PA  
**Color:** Black  
**Fender, door panel, spoiler**



C1623

**Material:** PA  
**Color:** Brown  
**Tail light, rear lower**



C1646

**Material:** PA  
**Color:** Black  
**Tail light**



C1755

**Material:** PA  
**Color:** Grey  
**Fender flare**



C3228

**Material:** PA  
**Color:** Grey  
**Liftgate**



C3279

**Material:** PE  
**Color:** Black  
**Rear bumper**



C3280

**Material:** PA  
**Color:** Light green  
**Floor, door panel**



C3300

**Material:** PA  
**Color:** Light green  
**Side moulding, rocker panel**



C3301

**Material:** PA  
**Color:** Light green  
**Cowl**



C3420

**Material:** PA  
**Color:** Natural  
**Door panel**



C3780

**Material:** PA  
**Color:** Light grey  
**Tail light**

## — SCREW GROMMET & NUT



C3874

**Material:** PA  
**Color:** Black  
**Rear tray, repair part**



C3911

**Material:** PA  
**Color:** White  
**Front bumper, side molding**



C3918

**Material:** PP  
**Color:** Natural  
**Door trim**



C3954

**Material:** PA  
**Color:** Black  
**Taillight**

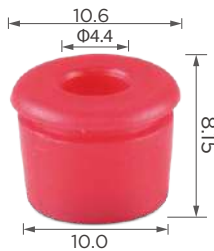

C0022

**Material:** PA  
**Color:** Red  
**Windows, body moulding, lining**



C0183

**Material:** POM  
**Color:** Black  
**Grille, headlight**



C0197

**Material:** POM  
**Color:** Black  
**Headlight, foglight**



C0238

**Material:** PA  
**Color:** White  
**Rear bumper**



C0259

**Material:** POM  
**Color:** White  
**Roof**



C0268

**Material:** POM  
**Color:** Black  
**Grille**

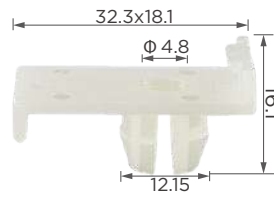

C0294

**Material:** PA  
**Color:** White  
**Door panel**

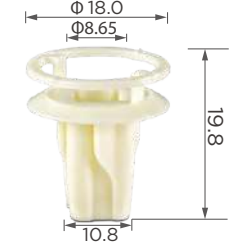

C0298

**Material:** PA  
**Color:** White  
**Splash guard**



C0299

**Material:** PA  
**Color:** Black  
**Hood**

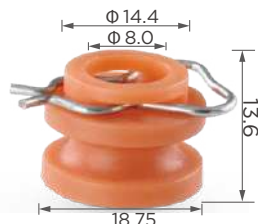

C0310

**Material:** PA  
**Color:** Orange  
**Window roller assembly**



C0365

**Material:** POM  
**Color:** White  
**Rocker panel, sill**



C0384

**Material:** PA  
**Color:** White  
**Headlight**

# SCREW GROMMET & NUT

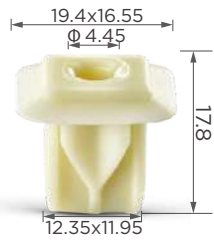

C0397

**Material:** PA  
**Color:** Beige  
**Door panel**



C0418

**Material:** PA  
**Color:** White  
**Headlight**



C0656

**Material:** PA  
**Color:** Blue  
**Front bumper**



C0802

**Material:** PA  
**Color:** White  
**Fuel line**



C0808

**Material:** PA  
**Color:** Red  
**Nut**



C0840

**Material:** PA  
**Color:** White  
**Speaker, audio**



C0895

**Material:** PA  
**Color:** Black  
**Hood, wheelarch, bumper, bottom**



C0897

**Material:** PA  
**Color:** Natural  
**Moulding insert**



C0917

**Material:** PA  
**Color:** White  
**Windows, lining**



C0949

**Material:** PA  
**Color:** White  
**Side moulding**



C0951

**Material:** PA  
**Color:** White  
**Headlight**



C0982

**Material:** PA  
**Color:** White  
**Rocker panel, sill**



C1097

**Material:** POM  
**Color:** White  
**Interior**

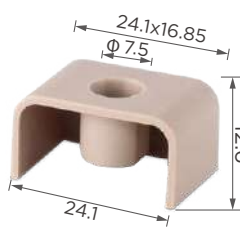

C1124

**Material:** PA  
**Color:** Grey yellow  
**Grommet**



C1174

**Material:** PA  
**Color:** Black  
**Front and rear bumper, fender**



C1179

**Material:** POM  
**Color:** White  
**Rocker panel, sill**



C1184

**Material:** PA  
**Color:** Black  
**Rear lamp**



C1189

**Material:** PA  
**Color:** White  
**Grommet**



C1217

**Material:** PA  
**Color:** Light yellow  
**Emblem**



C1269

**Material:** POM  
**Color:** Black  
**Wheelarch, splash guard**



# SCREW GROMMET & NUT



**C1330**

**Material:** PA  
**Color:** White  
**Grommet**



**C1346**

**Material:** POM  
**Color:** Black  
**Nut**



**C1347**

**Material:** POM  
**Color:** Black  
**Nut**



**C1357**

**Material:** PA  
**Color:** Light yellow  
**Grommet**



**C1362**

**Material:** PA  
**Color:** Natural  
**Grommet**



**C1464**

**Material:** POM  
**Color:** Black  
**Pillar garnish, roof, tailgate lining**



**C1476**

**Material:** PA  
**Color:** Black  
**Rear bumper**



**C1477**

**Material:** PA  
**Color:** Black  
**Rear bumper**



**C1506**

**Material:** PA  
**Color:** Beige  
**Foglight**



**C1586**

**Material:** PA  
**Color:** White  
**Wheelarch, under floor**



**C1588**

**Material:** PA  
**Color:** White  
**Door panel**



**C1610**

**Material:** PA  
**Color:** Black  
**Rear bumper**

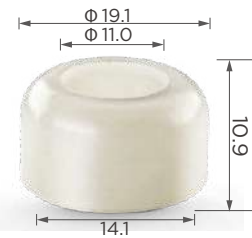

**C1629**

**Material:** PA  
**Color:** White  
**Nut**



**C1649**

**Material:** PA  
**Color:** Black  
**Front bumper**



**C1706**

**Material:** POM  
**Color:** Black  
**Fender flare**



**C1746**

**Material:** PA  
**Color:** White  
**Front bumper**



**C1785**

**Material:** PA  
**Color:** Green  
**Rocker panel, sill**



**C1823**

**Material:** PA  
**Color:** Grey  
**Liftgate**



**C1964**

**Material:** PA  
**Color:** Red  
**Side moulding, rocker panel, sill**



**C3045**

**Material:** POM  
**Color:** White  
**Nut**

# SCREW GROMMET & NUT



**C3047**

**Material:** POM  
**Color:** Grey  
**Rocker panel, sill**



**C3056**

**Material:** PA  
**Color:** White  
**Wheelarch, underfloor, engine, heat radiator**

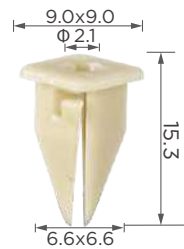

**C3078**

**Material:** PA  
**Color:** Beige  
**Wheelarch**



**C3079**

**Material:** POM  
**Color:** Black  
**Rear tray, door panel**



**C3080**

**Material:** POM  
**Color:** Black  
**Front bumper**



**C3179**

**Material:** POM  
**Color:** Black  
**Door panel**



**C3239**

**Material:** PA  
**Color:** Beige  
**Splash shield**



**C3258**

**Material:** PA  
**Color:** Yellow  
**Front bumper, grille**



**C3274**

**Material:** POM  
**Color:** White  
**Wheelarch, splash guard**

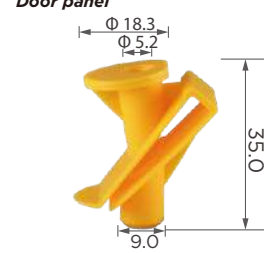

**C3388**

**Material:** POM  
**Color:** Yellow  
**Undertray**



**C3390**

**Material:** PA  
**Color:** Black  
**Rear bumper**



**C3453**

**Material:** PA  
**Color:** White  
**Cowl**



**C3461**

**Material:** PA  
**Color:** Natural  
**Emblem**



**C3499**

**Material:** POM  
**Color:** Natural  
**Side moulding, rocker panel, underbody**



**C3511**

**Material:** PP  
**Color:** Black  
**Side moulding, rocker panel**



**C3547**

**Material:** POM  
**Color:** Grey  
**Cowl, lower**

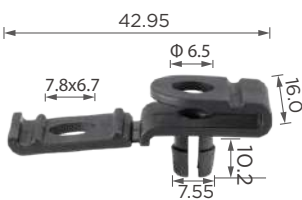

**C3551**

**Material:** PA  
**Color:** Black  
**Wheelarch, splash guard**



**C3557**

**Material:** POM  
**Color:** Black  
**Nut**



**C3667**

**Material:** POM  
**Color:** Black  
**Wheelarch fender liner**

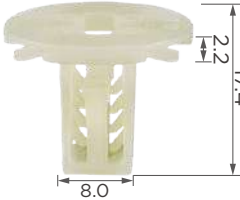

**C3682**

**Material:** PA  
**Color:** Light green  
**Rocker panel, under body shield**

# SCREW GROMMET & NUT



**C3737**

**Material:** TPU  
**Color:** Black  
**Grommet**



**C3738**

**Material:** TPU  
**Color:** Green  
**Grommet**



**C3754**

**Material:** POM  
**Color:** Yellow  
**Front and rear bumper, front frog lamp**

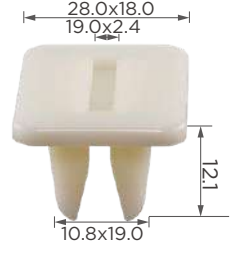

**C3789**

**Material:** PA  
**Color:** Beige  
**Rocker panel**



**C3792**

**Material:** PA  
**Color:** Green  
**Front and rear bumper**

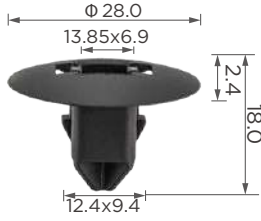

**C3795**

**Material:** PA  
**Color:** Black  
**Front bumper**



**C3797**

**Material:** PA  
**Color:** Natural  
**Tail light**



**C3848**

**Material:** POM  
**Color:** Green  
**Headlight**



**C3868**

**Material:** POM  
**Color:** Black  
**Mudguard, fender liner, under shield**



**C3875**

**Material:** PA  
**Color:** Light green  
**Side fender, undershield, car component**



**C3880**

**Material:** POM  
**Color:** Natural  
**Rear liftgate trim, door handle**



**C3901**

**Material:** PA  
**Color:** Black  
**Rear bumper, cowl**



**C3953**

**Material:** POM  
**Color:** Natural  
**Headlight**

# — PLASTIC U-TYPE NUT

**Product No.: C0048**

**Material:** PA  
**Color:** Black  
**Position:** Wheelarch, splash guard, fender

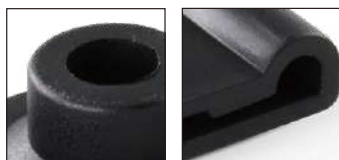

Product Details

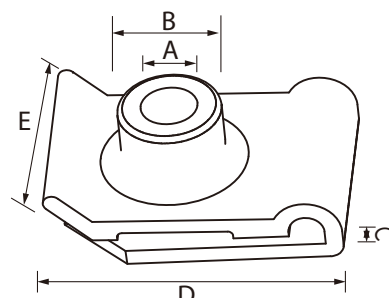

Part No.	Material	Color	mm					in				
			A	B	C	D	E	A	B	C	D	E
C0048	PA	Black	5.50	10.00	1.40	28.50	18.90	0.215	0.390	0.055	1.112	0.737
C0049	PA	Black	4.36	8.60	2.60	29.77	19.35	0.170	0.335	0.101	1.161	0.755
C0182	PA	Black	4.85	9.00	1.70	22.20	31.50	0.189	0.351	0.066	0.866	1.229
C0366	PA	Black	4.15	8.70	1.40	25.00	17.90	0.162	0.339	0.055	0.975	0.698
C0567	PA	Black	5.05	8.85	3.20	20.75	20.00	0.197	0.345	0.125	0.809	0.780
C0814	PA	Black	3.50	9.00	2.00	32.10	31.40	0.137	0.351	0.078	1.252	1.225
C0896	PA	Black	5.20	9.90	3.90	34.40	19.70	0.203	0.386	0.152	1.342	0.768
C0898	PA	Black	7.00	9.00	1.20	24.90	34.85	0.273	0.351	0.047	0.971	1.359
C1099	PA	Black	5.00	9.90	2.85	26.85	16.00	0.195	0.386	0.111	1.047	0.624
C1100	PA	Black	5.10	10.00	2.00	21.50	15.80	0.199	0.390	0.078	0.839	0.616
C1639	PA	Black	4.10	10.00	1.75	25.60	22.10	0.160	0.390	0.068	0.998	0.862
C1650	PA	Grey	4.00	9.00	2.90	22.10	20.10	0.156	0.351	0.113	0.862	0.784
C1678	PA	Natural	3.90	8.85	2.95	19.75	20.20	0.152	0.345	0.115	0.770	0.788
C1775	PA	Black	5.15	9.80	2.40	20.00	15.70	0.201	0.382	0.094	0.780	0.612
C1938	POM	Black	4.95	9.00	2.40	29.50	42.00	0.193	0.351	0.094	1.151	1.638
C1969	POM	Black	6.65	9.9x11.2	4.14	28.20	15.80	0.259	0.386x0.437	0.161	1.100	0.616
C1977	PA	Grey	4.10	8.75	3.07	20.85	19.85	0.160	0.341	0.120	0.813	0.774
C1991	PA	Black	7.90	29.8x18.65	1.80	30.10	29.80	0.308	1.162x0.727	0.070	1.174	1.162
C3030	POM	Dark grey	5.60	11.80	1.80	19.15	17.60	0.218	0.460	0.070	0.747	0.686
C3162	POM	Dark grey	5.00	9.00	2.55	29.00	39.20	0.195	0.351	0.099	1.131	1.529
C3387	PA	Dark grey	9.70	/	2.55	32.45	22.10	0.378	/	0.099	1.266	0.862



# — PLASTIC U-TYPE NUT



C0048

**Material:** PA  
**Color:** Black  
*Wheelarch, splash guard, fender*



C0049

**Material:** PA  
**Color:** Black  
*Wheelarch, splash guard, fender*



C0182

**Material:** PA  
**Color:** Black  
*Wheelarch, splash guard, fender, side moulding*



C0366

**Material:** PA  
**Color:** Black  
*Floor attachment, wheelarch*

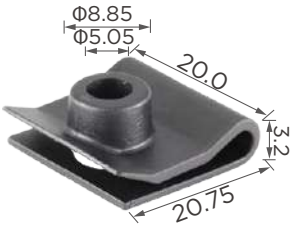

C0567

**Material:** PA  
**Color:** Black  
*Side moulding, rear bumper, fender, splash guard*



C0814

**Material:** PA  
**Color:** Black  
*Wheelarch, fender*



C0896

**Material:** PA  
**Color:** Black  
*Front bumper, wheelarch, splash guard*



C0898

**Material:** PA  
**Color:** Black  
*Front bumper, wheelarch, splash guard*



C1099

**Material:** PA  
**Color:** Black  
*U-type nut*



C1100

**Material:** PA  
**Color:** Black  
*Splash guard, front and rear bumper*



C1639

**Material:** PA  
**Color:** Black  
*Mud guard, spoiler*



C1650

**Material:** PA  
**Color:** Grey  
*Front and rear bumper*



C1678

**Material:** PA  
**Color:** Natural  
*Wheelarch, splash guard*



C1775

**Material:** PA  
**Color:** Black  
*Wheelarch, side panel support*



C1938

**Material:** POM  
**Color:** Black  
*Front bumper, wheelarch, splash guard*



C1969

**Material:** POM  
**Color:** Black  
*Front bumper*



C1977

**Material:** PA  
**Color:** Grey  
*Front bumper*



C1991

**Material:** PA  
**Color:** Black  
*Wheelarch, splash guard*



C3030

**Material:** POM  
**Color:** Dark grey  
*U-type nut*



C3162

**Material:** POM  
**Color:** Dark grey  
*Front bumper*



## — PLASTIC U-TYPE NUT



C3387

**Material:** PA

**Color:** Dark grey

**Front end, splash guard**

# — PLASTIC BLIND RIVET

**Product No.:** C0162

**Material:** PA  
**Color:** Black  
**Position:** Wheelarch



Product Details

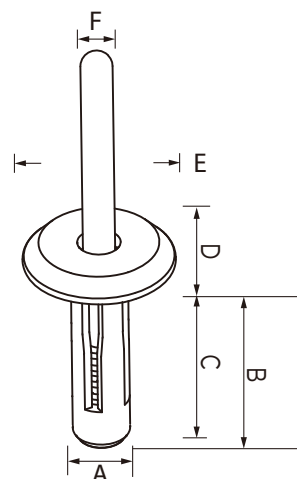

Part No.	Material	Color	mm						in					
			A	B	C	D	E	F	A	B	C	D	E	F
C1240	PA	White	3.75	18.60	12.30	1.30	8.95	2.30	0.146	0.725	0.480	0.051	0.349	0.090
C0239	PA	Black	3.80	19.00	16.00	2.65	15.0 x7.6	2.30	0.148	0.741	0.624	0.103	0.585x0.296	0.090
C1239	PA	White	3.80	14.80	8.40	1.30	8.95	2.35	0.148	0.577	0.328	0.051	0.349	0.092
C3354	PA	Black	3.80	19.25	16.25	2.55	8.00	2.45	0.148	0.751	0.634	0.099	0.312	0.096
C0161	PA	Black	3.90	26.50	23.90	2.30	15.4x8.0	2.25	0.152	1.034	0.932	0.090	0.601x0.312	0.088
C0459	PA	Black	4.70	18.90	15.80	2.50	9.00	3.10	0.183	0.737	0.616	0.098	0.351	0.121
C0468	PA	Black	4.75	16.75	15.15	1.75	8.80	2.80	0.185	0.653	0.591	0.068	0.343	0.109
C3399	PA	Black	4.80	18.20	15.15	1.75	9.00	2.90	0.187	0.710	0.591	0.068	0.351	0.113
C3452	PA	Black	4.80	16.70	15.05	1.80	8.85	2.90	0.187	0.651	0.587	0.070	0.345	0.113
C0200	PA	Black	4.85	20.80	17.60	2.00	12.30	2.85	0.189	0.811	0.686	0.078	0.480	0.111
C1241	PA	White	4.85	15.25	8.30	1.50	10.90	2.90	0.189	0.595	0.324	0.059	0.425	0.113
C1242	PA	White	4.85	19.45	12.50	1.40	10.90	2.90	0.189	0.759	0.488	0.055	0.425	0.113
C0204	PA	Black	4.90	25.60	22.50	2.00	12.35	2.90	0.191	0.998	0.878	0.078	0.482	0.113
C0460	PA	Black	5.00	18.90	15.70	3.20	11.60	3.00	0.195	0.737	0.612	0.125	0.452	0.117
C0462	PA	Black	5.10	20.75	17.45	2.50	12.90	4.00	0.199	0.809	0.681	0.098	0.503	0.156
C3298	PA	White	5.70	20.95	18.95	2.60	12.40	3.40	0.222	0.817	0.739	0.101	0.484	0.133
C1243	PA	White	5.75	16.50	8.60	1.40	12.90	3.60	0.224	0.644	0.335	0.055	0.503	0.140
C1244	PA	White	5.75	19.75	12.05	1.45	12.85	3.45	0.224	0.770	0.470	0.057	0.501	0.135
C1988	PA	Black	5.75	21.65	19.60	3.45	20.00	2.10	0.224	0.844	0.764	0.135	0.780	0.082
C0282	PA	Black/ White	5.80	20.32	18.17	2.48	19.70	3.45	0.226	0.792	0.709	0.097	0.768	0.135
C0467	PA	Black	5.90	28.70	25.40	2.60	12.70	3.65	0.230	1.119	0.991	0.101	0.495	0.142
C0202	PA	Black	6.00	29.10	26.20	2.40	13.00	3.60	0.234	1.135	1.022	0.094	0.507	0.140
C0557	PA	Black	6.00	31.80	28.80	2.40	16.80	3.90	0.234	1.240	1.123	0.094	0.655	0.152
C0604	PA	Black	6.00	18.20	15.20	2.60	16.95	3.75	0.234	0.710	0.593	0.101	0.661	0.146
C0375	PA	White	6.05	28.90	26.00	2.55	16.70	3.55	0.236	1.127	1.014	0.099	0.651	0.138
C0201	PA	Black	6.10	28.95	25.95	2.60	16.70	3.70	0.238	1.129	1.012	0.101	0.651	0.144
C0346	PA	Beige+White	6.10	18.35	15.20	2.60	16.85	3.90	0.238	0.716	0.593	0.101	0.657	0.152
C0477	PA	Black	6.10	28.50	25.20	2.70	16.70	3.90	0.238	1.112	0.983	0.105	0.651	0.152
C0585	PA	Black	6.10	20.25	17.20	2.50	16.35	3.80	0.238	0.790	0.671	0.098	0.638	0.148
C0586	PA	Black	6.10	28.75	25.50	2.40	16.80	3.90	0.238	1.121	0.995	0.094	0.655	0.152

# PLASTIC BLIND RIVET

Part No.	Material	Color	mm						in					
			A	B	C	D	E	F	A	B	C	D	E	F
C0194	PA	Black+White	6.15	19.25	17.55	2.55	16.65	3.90	0.240	0.751	0.684	0.099	0.649	0.152
C0461	PA	Beige+White	6.15	18.20	15.10	2.60	16.80	3.90	0.240	0.710	0.589	0.101	0.655	0.152
C0592	PA	Black/ White	6.15	28.85	25.75	2.50	16.80	3.80	0.240	1.125	1.004	0.098	0.655	0.148
C0524	PA	Black	6.20	21.20	19.50	2.50	16.80	3.95	0.242	0.827	0.761	0.098	0.655	0.154
C0162	PA	Black	6.60	24.55	22.95	2.60	17.60	3.70	0.257	0.957	0.895	0.101	0.686	0.144
C0203	PA	Black	6.70	20.90	17.80	2.50	17.60	3.70	0.261	0.815	0.694	0.098	0.686	0.144
C0523	PA	Black	6.70	24.65	23.05	2.55	17.60	3.70	0.261	0.961	0.899	0.099	0.686	0.144



C0161

**Material:** PA  
**Color:** Black  
*Cowl, grille, wheelarch*



C0162

**Material:** PA  
**Color:** Black  
*Wheelarch*



C0194

**Material:** PA  
**Color:** Black+White  
*Side moulding*



C0200

**Material:** PA  
**Color:** Black  
*Wheelarch*



C0201

**Material:** PA  
**Color:** Black  
*Front bumper, grille, wheelarch, rear quarter panel*



C0202

**Material:** PA  
**Color:** Black  
*Rocker panel, front bumper*



C0203

**Material:** PA  
**Color:** Black  
*Blind rivet*



C0204

**Material:** PA  
**Color:** Black  
*Front bumper*

# — PLASTIC BLIND RIVET



C0239

**Material:** PA  
**Color:** Black  
**Blind rivet**



C0282

**Material:** PA  
**Color:** Black/ White  
**Front and rear bumper, wheelarch, rocker panel, rear tray**

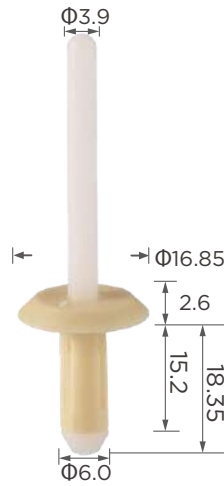

C0346

**Material:** PA  
**Color:** Beige+White  
**Blind rivet**



C0375

**Material:** PA  
**Color:** White  
**Blind rivet**

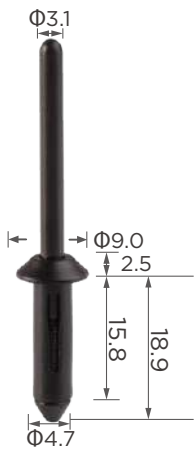

C0459

**Material:** PA  
**Color:** Black  
**Blind rivet**



C0460

**Material:** PA  
**Color:** Black  
**Front and rear bumper**

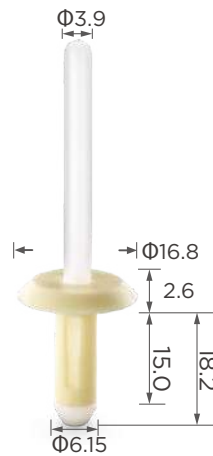

C0461

**Material:** PA  
**Color:** Beige+White  
**Blind rivet**



C0462

**Material:** PA  
**Color:** Black  
**Blind rivet**



C0467

**Material:** PA  
**Color:** Black  
**Front bumper, refrigeration system**



C0468

**Material:** PA  
**Color:** Black  
**Front bumper, jack stowage, side moulding**



C0477

**Material:** PA  
**Color:** Black  
**Blind rivet**



C0523

**Material:** PA  
**Color:** Black  
**Wheelarch**

# — PLASTIC BLIND RIVET



**C0524**

**Material:** PA  
**Color:** Black  
**Splash guard**



**C0557**

**Material:** PA  
**Color:** Black  
**Front bumper, wheelarch**



**C0585**

**Material:** PA  
**Color:** Black  
**Rocker panel, side moulding**

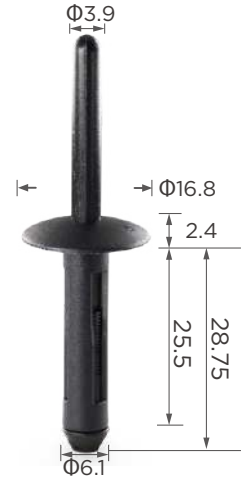

**C0586**

**Material:** PA  
**Color:** Black  
**Rear bumper**



**C0592**

**Material:** PA  
**Color:** Black/ White  
**Door panel**



**C0604**

**Material:** PA  
**Color:** Black  
**Blind rivet**

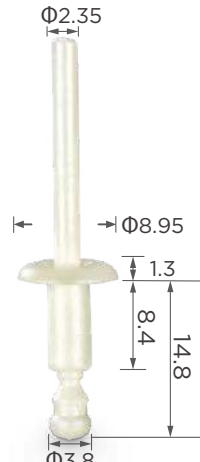

**C1239**

**Material:** PA  
**Color:** White  
**Blind rivet**

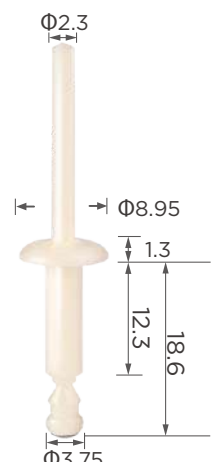

**C1240**

**Material:** PA  
**Color:** White  
**Blind rivet**

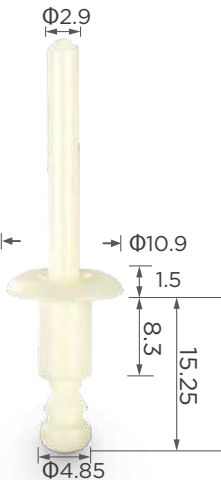

**C1241**

**Material:** PA  
**Color:** White  
**Blind rivet**

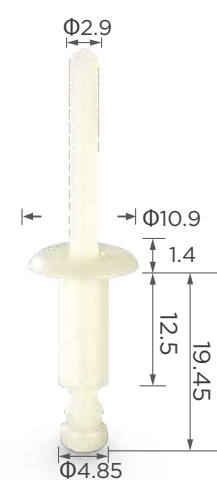

**C1242**

**Material:** PA  
**Color:** White  
**Blind rivet**

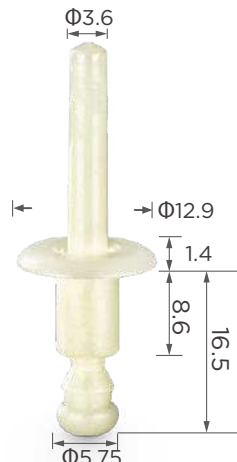

**C1243**

**Material:** PA  
**Color:** White/ Black/ Beige  
**Blind rivet**

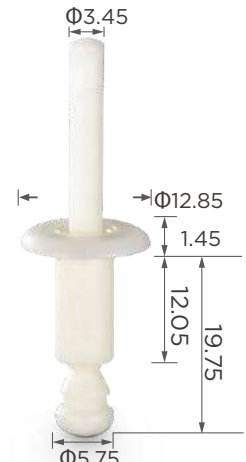

**C1244**

**Material:** PA  
**Color:** White  
**Blind rivet**



## — PLASTIC BLIND RIVET



C1988

**Material:** PA  
**Color:** Black  
*Wheelarch, rocker panel*

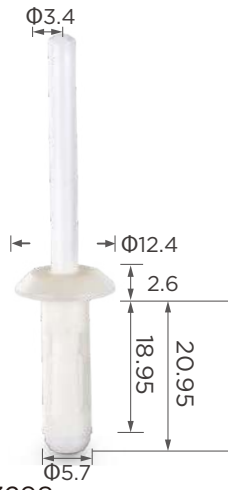

C3298

**Material:** PA  
**Color:** White  
*Air duct, grille, door panel*



C3354

**Material:** PA  
**Color:** Black  
*Blind rivet*

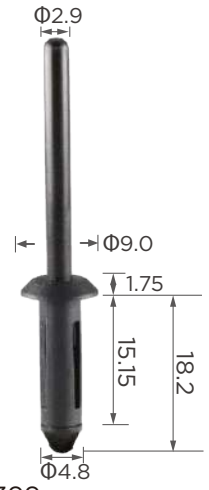

C3399

**Material:** PA  
**Color:** Black  
*Rear bumper*



C3452

**Material:** PA  
**Color:** Black  
*Side moulding, front bumper*

# CONNECTOR

**Product No.:** C0403

**Material:** PA  
**Color:** Black  
**Position:** Straight connector



Product Details

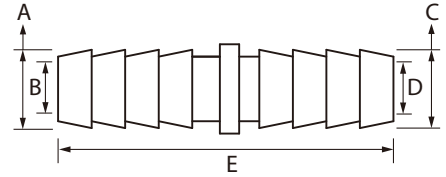

Part No.	Material	Color	mm					in				
			A	B	C	D	E	A	B	C	D	E
C0400	PA	Black	4.55	2.45	4.55	2.45	16.80	1.542	0.831	1.542	0.831	5.695
C0401	PA	Black	6.35	3.00	6.35	3.00	40.15	2.153	1.017	2.153	1.017	13.611
C0402	PA	Black	7.70	3.90	7.70	3.90	40.00	2.610	1.322	2.610	1.322	13.560
C0403	PA	Black	9.40	5.60	9.40	5.60	40.60	3.187	1.898	3.187	1.898	13.763
C0404	PA	Black	6.15	3.30	6.15	4.05	40.45	2.085	1.119	2.085	1.373	13.713
C0419	ABS	Black	4.65	1.40	4.65	1.40	89.20	1.576	0.475	1.576	0.475	30.239
C0446	PA	White	4.10	2.00	4.10	2.00	28.60	1.390	0.678	1.390	0.678	9.695
C0447	PA	Black	5.10	2.40	5.65	3.20	34.00	1.729	0.814	1.915	1.085	11.526
C0448	PA	White	8.00	4.70	8.00	4.70	38.20	2.712	1.593	2.712	1.593	12.950
C0449	PA	White	10.50	6.60	10.50	6.60	44.70	3.560	2.237	3.560	2.237	15.153
C0450	PA	Black	4.55	2.80	6.95	3.85	29.65	1.542	0.949	2.356	1.305	10.051
C0451	PA	Black	2.80	2.00	6.10	4.70	30.10	0.949	0.678	2.068	1.593	10.204
C0452	PA	White	5.90	2.95	5.90	2.95	35.50	2.000	1.000	2.000	1.000	12.035
C0871	PA	Black	6.20	4.20	9.30	7.80	37.50	2.102	1.424	3.153	2.644	12.713
C0874	PA	Black	7.65	5.90	7.65	5.90	40.30	2.593	2.000	2.593	2.000	13.662
C1363	PA	Black	6.00	2.80	5.00	2.80	25.00	2.034	0.949	1.695	0.949	8.475
C1474	POM	Black+White	6.10	3.40	6.10	3.40	26.00	2.068	1.153	2.068	1.153	8.814
C1495	PA	Black	6.25	3.00	10.80	9.10	26.10	2.119	1.017	3.661	3.085	8.848
C1751	PA	Black	5.80	3.50	5.80	3.50	30.00	1.966	1.187	1.966	1.187	10.170
C1932	PA	Black	5.80	3.00	5.80	3.00	38.00	1.966	1.017	1.966	1.017	12.882
C3202	POM	Black	6.00	3.50	6.00	3.50	26.00	2.034	1.187	2.034	1.187	8.814
C3408	PA	Black	4.50	3.30	4.50	3.30	30.45	1.526	1.119	1.526	1.119	10.323
C3694	PA	Black	10.80	3.20	10.80	6.20	39.80	3.661	1.085	3.661	2.102	13.492
C3770	POM	Black	7.05	3.50	6.20	3.50	26.00	2.390	1.187	2.102	1.187	8.814

# CONNECTOR

**Product No.:** C0417

**Material:** PA  
**Color:** Black  
**Position:** 3-way tee connector



Product Details

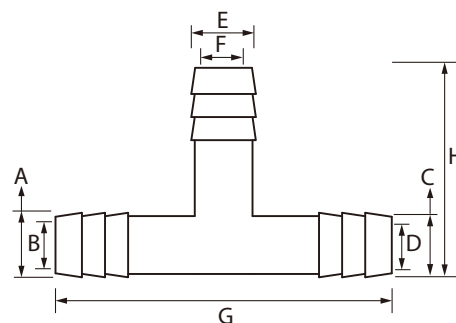

Part No.	Material	Color	mm								in							
			A	B	C	D	E	F	G	H	A	B	C	D	E	F	G	H
C0241	PA	Light green	7.85	4.80	7.85	4.80	5.80	3.20	45.10	25.70	2.661	1.627	2.661	1.627	1.966	1.085	15.289	8.712
C0405	PA	Black	4.80	2.50	4.80	2.50	4.80	2.50	39.00	22.00	1.627	0.848	1.627	0.848	1.627	0.848	13.221	7.458
C0406	PA	Black	5.90	2.70	5.90	2.70	5.90	2.70	38.80	21.10	2.000	0.915	2.000	0.915	2.000	0.915	13.153	7.153
C0407	PA	Black	7.60	3.90	7.60	3.90	7.50	4.00	47.50	22.70	2.576	1.322	2.576	1.322	2.543	1.356	16.103	7.695
C0411	ABS	Black	4.60	1.25	4.60	1.40	4.60	1.40	89.60	53.35	1.559	0.424	1.559	0.475	1.559	0.475	30.374	18.086
C0412	PA	Black	3.90	2.00	3.90	2.00	3.90	2.00	31.20	18.30	1.322	0.678	1.322	0.678	1.322	0.678	10.577	6.204
C0417	PA	Black	10.60	6.20	10.60	6.20	10.60	6.20	55.30	33.90	3.593	2.102	3.593	2.102	3.593	2.102	18.747	11.492
C0438	PA	Light green	4.80	3.00	3.50	1.85	4.00	1.80	35.00	21.85	1.627	1.017	1.187	0.627	1.356	0.610	11.865	7.407
C0439	PA	White	5.50	2.90	5.50	2.90	5.50	2.90	37.00	24.10	1.865	0.983	1.865	0.983	1.865	0.983	12.543	8.170
C0440	PA	Light green	8.00	4.50	6.00	2.70	6.00	2.70	42.30	17.70	2.712	1.526	2.034	0.915	2.034	0.915	14.340	6.000
C0441	PA	Black	8.00	5.70	8.00	5.70	8.00	5.70	47.50	27.60	2.712	1.932	2.712	1.932	2.712	1.932	16.103	9.356
C0442	PA	Black	11.60	7.90	11.60	7.90	8.10	3.90	45.90	31.50	3.932	2.678	3.932	2.678	2.746	1.322	15.560	10.679
C0443	PA	White	4.20	1.90	4.20	1.90	4.20	1.90	32.60	15.00	1.424	0.644	1.424	0.644	1.424	0.644	11.051	5.085
C0444	PA	Black	4.40	3.10	4.40	3.10	4.10	1.90	35.20	22.50	1.492	1.051	1.492	1.051	1.390	0.644	11.933	7.628
C0505	PA	Black	9.10	5.40	9.10	5.40	9.10	5.40	56.10	25.90	3.085	1.831	3.085	1.831	3.085	1.831	19.018	8.780
C0577	PA	Light green	6.20	4.80	6.20	4.80	6.20	4.80	52.10	35.00	2.102	1.627	2.102	1.627	2.102	1.627	17.662	11.865
C0838	PA	Black	9.30	8.00	9.30	8.00	9.30	8.00	47.30	30.80	3.153	2.712	3.153	2.712	3.153	2.712	16.035	10.441
C0863	TPR	Black	6.90	3.40	6.90	3.40	6.70	3.50	38.50	23.65	2.339	1.153	2.339	1.153	2.271	1.187	13.052	8.017
C0878	PA	Black	9.10	8.00	6.20	4.20	9.10	8.00	46.30	30.90	3.085	2.712	2.102	1.424	3.085	2.712	15.696	10.475
C0879	PA	Light green	3.30	1.90	3.30	1.90	6.80	3.90	32.60	21.80	1.119	0.644	1.119	0.644	2.305	1.322	11.051	7.390
C0881	PA	Light green	4.50	3.10	4.20	2.00	6.00	3.10	34.70	23.50	1.526	1.051	1.424	0.678	2.034	1.051	11.763	7.967
C1161	PA	Black	10.30	7.00	10.30	7.00	10.30	7.00	57.90	35.80	3.492	2.373	3.492	2.373	3.492	2.373	19.628	12.136
C1198	PA	White	5.10	3.00	5.10	3.00	6.40	4.00	31.30	18.45	1.729	1.017	1.729	1.017	2.170	1.356	10.611	6.255
C3369	PA	Black	25.00	20.00	25.00	20.00	15.00	10.00	90.00	60.70	8.475	6.780	8.475	6.780	5.085	3.390	30.510	20.577
C3407	PA	Black	5.90	2.60	5.90	2.60	5.90	2.60	36.50	21.40	2.000	0.881	2.000	0.881	2.000	0.881	12.374	7.255



## CONNECTOR



C0400

**Material:** PA  
**Color:** Black  
**Straight connector**



C0401

**Material:** PA  
**Color:** Black  
**Straight connector**



C0402

**Material:** PA  
**Color:** Black  
**Straight connector**



C0403

**Material:** PA  
**Color:** Black  
**Straight connector**



C0404

**Material:** PA  
**Color:** Black  
**Straight connector**



C0419

**Material:** ABS  
**Color:** Black  
**Straight connector**

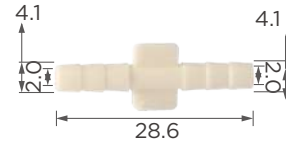

C0446

**Material:** PA  
**Color:** White  
**Cruise control**

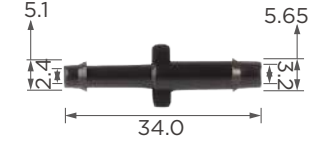

C0447

**Material:** PA  
**Color:** Black  
**Cruise control**



C0448

**Material:** PA  
**Color:** White  
**Emission control**



C0449

**Material:** PA  
**Color:** White  
**Crankcase ventilation, speed control**



C0450

**Material:** PA  
**Color:** Black  
**Straight connector**



C0451

**Material:** PA  
**Color:** Black  
**Straight connector**



C0452

**Material:** PA  
**Color:** White  
**Straight connector**



C0871

**Material:** PA  
**Color:** Black  
**Fuel pump tube**



C0874

**Material:** PA  
**Color:** Black  
**Vapor canister vent**



C1363

**Material:** PA  
**Color:** Black  
**Straight connector**



C1474

**Material:** POM  
**Color:** Black+White  
**Straight connector**



C1495

**Material:** PA  
**Color:** Black  
**Straight connector**



C1751

**Material:** PA  
**Color:** Black  
**Straight connector**



C1932

**Material:** PA  
**Color:** Black  
**Straight connector**

## CONNECTOR



C3202

**Material:** POM  
**Color:** Black  
**Straight connector**



C3408

**Material:** PA  
**Color:** Black  
**Straight connector**



C3694

**Material:** PA  
**Color:** Black  
**Straight connector**



C3770

**Material:** POM  
**Color:** Black  
**Straight connector**

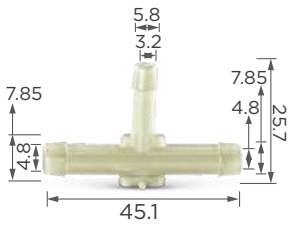
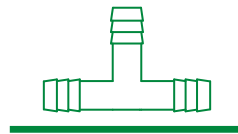

C0241

**Material:** PA  
**Color:** Light green  
**3-way tee connector**

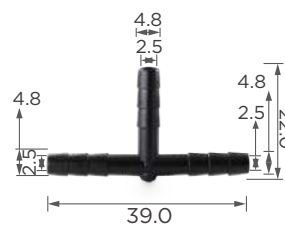

C0405

**Material:** PA  
**Color:** Black  
**3-way tee connector**

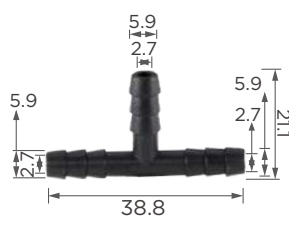

C0406

**Material:** PA  
**Color:** Black  
**3-way tee connector**



C0407

**Material:** PA  
**Color:** Black  
**3-way tee connector**

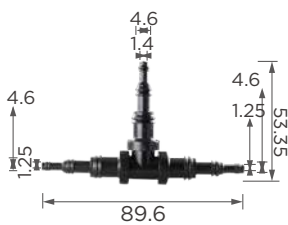

C0411

**Material:** ABS  
**Color:** Black  
**3-way tee connector**

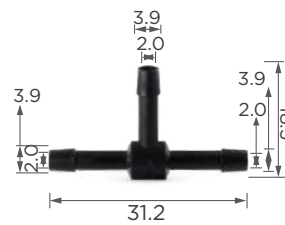

C0412

**Material:** PA  
**Color:** Black  
**3-way tee connector**



C0417

**Material:** PA  
**Color:** Black  
**3-way tee connector**

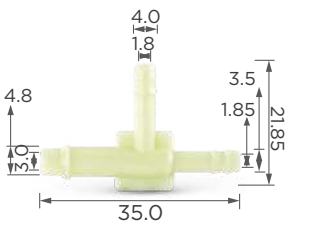

C0438

**Material:** PA  
**Color:** Light green  
**3-way tee connector**

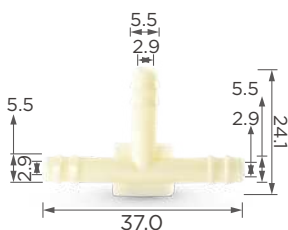

C0439

**Material:** PA  
**Color:** White  
**Windshield wiper and washer**

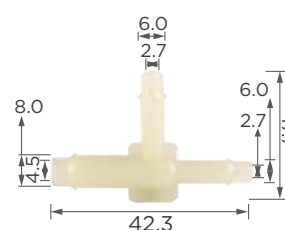

C0440

**Material:** PA  
**Color:** Light green  
**Gear box tube**

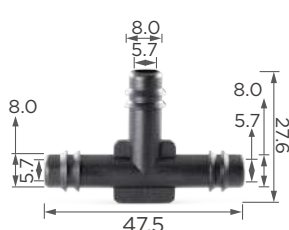

C0441

**Material:** PA  
**Color:** Black  
**3-way tee connector**

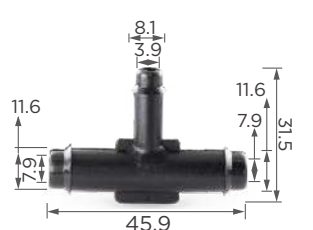

C0442

**Material:** PA  
**Color:** Black  
**3-way tee connector**

## CONNECTOR

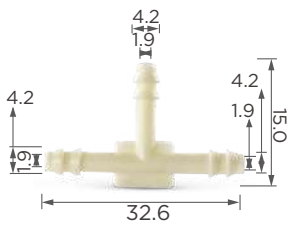

C0443

**Material:** PA  
**Color:** White  
*Windshield wiper and washer, emission control system*

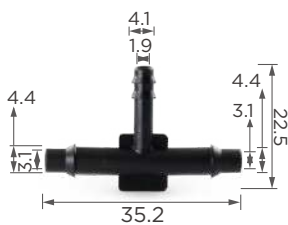

C0444

**Material:** PA  
**Color:** Black  
*3-way tee connector*



C0505

**Material:** PA  
**Color:** Black  
*3-way tee connector*

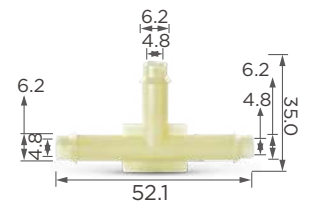

C0577

**Material:** PA  
**Color:** Black  
*3-way tee connector*

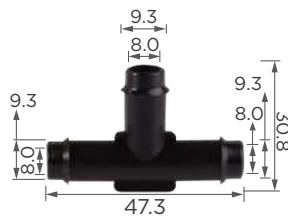

C0838

**Material:** PA  
**Color:** Black  
*Vapor canister and related part, emission control system*



C0863

**Material:** PA  
**Color:** Black  
*3-way tee connector*

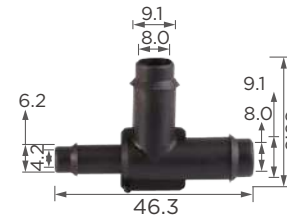

C0878

**Material:** TPR  
**Color:** Black  
*3-way tee connector*

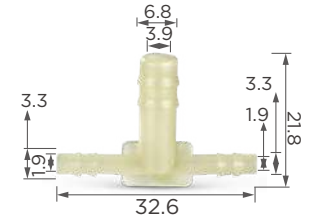

C0879

**Material:** PA  
**Color:** Light green  
*3-way tee connector*

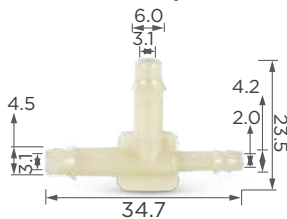

C0881

**Material:** PA  
**Color:** Light green  
*Cruise control, emission control*

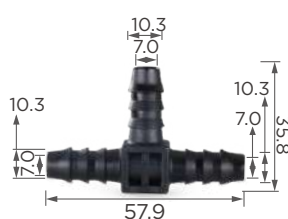

C1161

**Material:** PA  
**Color:** Black  
*3-way tee connector*

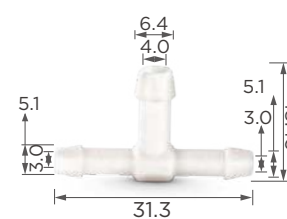

C1198

**Material:** PA  
**Color:** White  
*3-way tee connector*

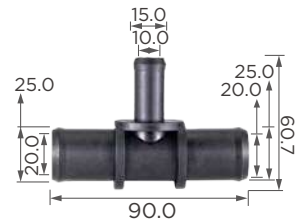

C3369

**Material:** PA  
**Color:** Black  
*3-way tee connector*

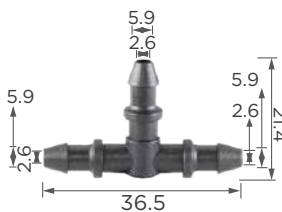

C3407

**Material:** PA  
**Color:** Black  
*3-way tee connector*

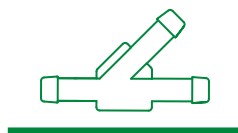



## CONNECTOR



C0386

**Material:** PA  
**Color:** Black  
**Drainage system**

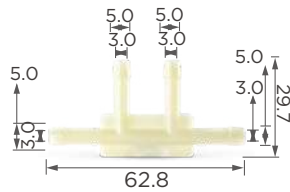

C0422

**Material:** PA  
**Color:** White  
**Emission control system**

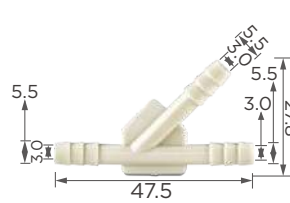

C0445

**Material:** PA  
**Color:** White  
**Windshield wiper and washer**

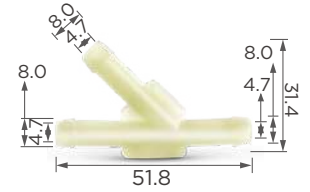

C0453

**Material:** PA  
**Color:** Light green  
**Front Axle and Axle Center**



C0454

**Material:** PA  
**Color:** Black  
**3-way connector**

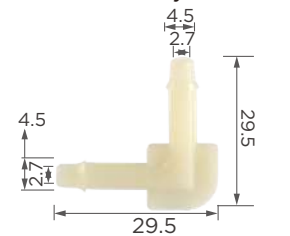

C0859

**Material:** PA  
**Color:** Light green  
**Elbow connector**

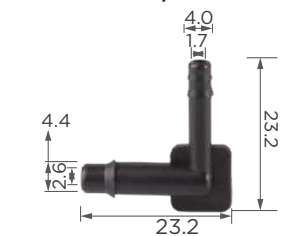

C0865

**Material:** PA  
**Color:** Black  
**Elbow connector**



C0868

**Material:** POM  
**Color:** Black  
**4-way connector**



C0870

**Material:** PA  
**Color:** Light green  
**Elbow connector**

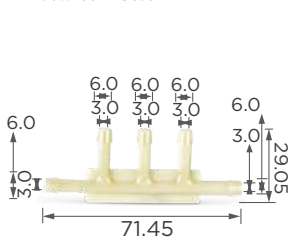

C0877

**Material:** PA  
**Color:** Light yellow  
**5-way connector**



C1086

**Material:** PA  
**Color:** Light green  
**Elbow connector**



C1154

**Material:** PA  
**Color:** Black  
**Elbow connector**



C1160

**Material:** PA  
**Color:** Black  
**5-way connector**

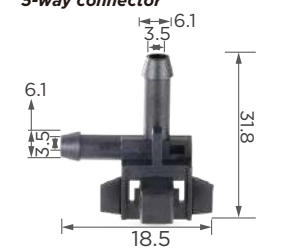

C1193

**Material:** POM  
**Color:** Black  
**Connector**



C1194

**Material:** PA  
**Color:** Black  
**Connector**



C1197

**Material:** PA  
**Color:** Black  
**Straight connector**

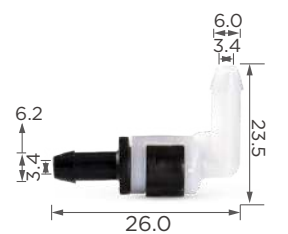

C1475

**Material:** POM  
**Color:** Black  
**Elbow connector**



C1494

**Material:** POM  
**Color:** Black  
**Connector**

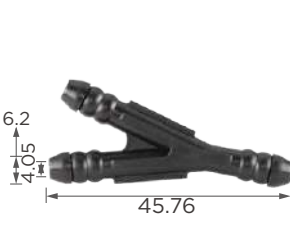

C3200

**Material:** POM  
**Color:** Black  
**3-way connector**



C3201

**Material:** POM  
**Color:** Black  
**Elbow connector**

## CONNECTOR



C3411

**Material:** POM  
**Color:** Black  
**Elbow connector**



C3412

**Material:** POM  
**Color:** Black  
**Elbow connector**



C3627

**Material:** POM  
**Color:** Black  
**Elbow connector**

## CABLE TIE

**Product No.: C0154**

**Material:** PA  
**Color:** Black  
**Style:** Winged arrow head

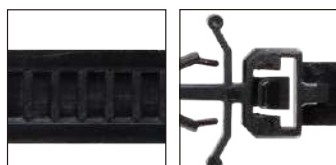

Product Details

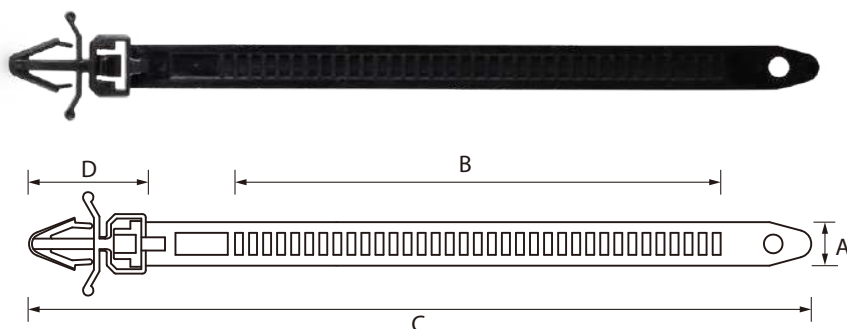

Part No.	Material	Color	Style	mm				in			
				A	B	C	D	A	B	C	D
C0154	PA	Black	Winged arrow head push mount	7.90	88.20	142.00	21.10	0.308	3.440	5.538	0.823
C0232	PA	Black	Offset arrow slot e	9.00	48.80	119.40	8.70	0.351	1.903	4.657	0.339
C0233	PA	Black	Offset arrow slot e	8.50	89.40	160.20	8.70	0.332	3.487	6.248	0.339
C0279	PA	Black	Winged arrow head push mount	8.00	60.00	112.00	22.80	0.312	2.340	4.368	0.889
C0320	PA	Black	Winged arrow head push mount	4.80	145.00	203.50	20.20	0.187	5.655	7.937	0.788
C0703	PA	Black	Winged arrow head push mount	6.60	102.80	159.10	20.60	0.257	4.009	6.205	0.803
C0822	PA	Blue	Strap push mount	6.00	100.40	125.50	13.50	0.234	3.916	4.895	0.527
C1046	PA	Black	Threaded stud e	5.90	145.30	182.00	16.90	0.230	5.667	7.098	0.659
C1048	PA	Black	Threaded stud e	5.00	130.00	170.00	16.20	0.195	5.070	6.630	0.632
C1049	PA	Black	Arrow slot e	7.00	106.50	156.30	18.30	0.273	4.154	6.096	0.714
C1050	PA	Black	Arrow slot e	6.90	140.50	170.40	15.00	0.269	5.480	6.646	0.585
C1051	PA	Black	Arrow slot e	9.30	133.90	182.00	16.60	0.363	5.222	7.098	0.647
C1170	PA	Black	Arrow slot e	4.50	101.60	150.00	16.25	0.176	3.962	5.850	0.634
C1171	PA	Black/ Grey	Arrow slot e	3.10	101.30	130.00	12.30	0.121	3.951	5.070	0.480
C1333	PA	Black	Arrow slot e	7.10	115.80	160.00	12.60	0.277	4.516	6.240	0.491
C3352	PA	Grey	Fir tree on strap	4.70	170.00	199.90	14.60	0.183	6.630	7.796	0.569
C3358	PA	Natural	Threaded stud e	5.40	66.60	176.00	9.60	0.211	2.597	6.864	0.374
C3440	PA	Black	Arrow slot e	5.30	132.70	175.00	16.00	0.207	5.175	6.825	0.624
C3501	PA	Black	Cable e with pipe clip	3.00	72.50	115.00	37.40	0.117	2.828	4.485	1.459
C3578	PA	Light Grey	Cable e with pipe clip	4.90	120.70	155.00	12.00	0.191	4.707	6.045	0.468
C3580	PA	Black	Cable e with pipe clip	4.70	118.90	158.70	24.10	0.183	4.637	6.189	0.940
C3587	PA	Black	Winged arrow head push mount	5.20	124.40	176.90	19.60	0.203	4.852	6.899	0.764
C3747	PA	Black	Arrow slot e	5.35	118.10	161.00	15.70	0.209	4.606	6.279	0.612
C3821	Nylon	Black	Tie wrap with sicket ratchet	4.70	170.00	199.90	6.00	0.183	6.630	7.796	0.234
C3913	PE	Natural	Wire Harnless Strap	11.30	34.30	90.00	6.20	0.441	1.338	3.510	0.242
C3914	Nylon	Dark grey	Strap	7.80	70.72	81.00	7.20	0.304	2.758	3.159	0.281
C3916	PE	Black	Strap	10.70	55.70	66.50	7.80	0.417	2.172	2.594	0.304
C3917	Nylon	Black	Wire Harnless Strap	7.45	93.40	103.50	10.90	0.291	3.643	4.037	0.425

## CABLE TIE

C0154

Material: PA  
Color: Black  
Winged arrow head push mount



C0232

Material: PA  
Color: Black  
Offset arrow slot tie



C0233

Material: PA  
Color: Black  
Offset arrow slot tie



C0279

Material: PA  
Color: Black  
Winged arrow head push mount



C0320

Material: PA  
Color: Black  
Winged arrow head push mount



C0703

Material: PA  
Color: Black  
Winged arrow head push mount



C0822

Material: PA  
Color: Blue  
Strap push mount

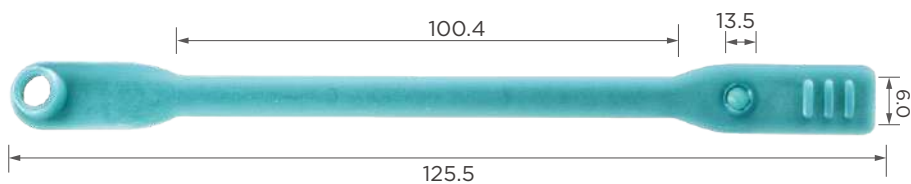

## CABLE TIE

C1046

**Material:** PA  
**Color:** Black  
**Threaded stud tie**



C1048

**Material:** PA  
**Color:** Black  
**Threaded stud tie**

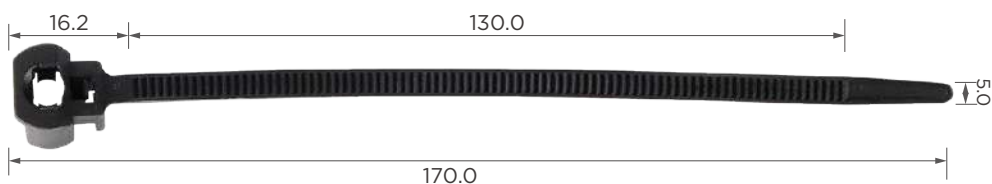

C1049

**Material:** PA  
**Color:** Black  
**Arrow slot tie**



C1050

**Material:** PA  
**Color:** Black  
**Arrow slot tie**



C1051

**Material:** PA  
**Color:** Black  
**Arrow slot tie**



C1170

**Material:** PA  
**Color:** Black  
**Arrow slot tie**

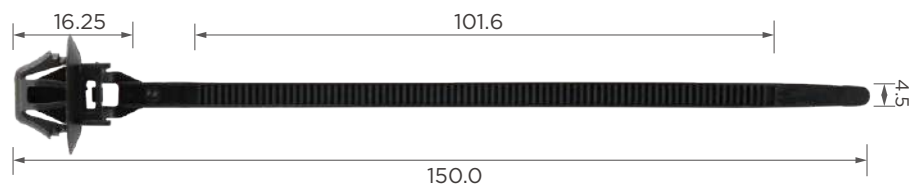

C1171

**Material:** PA  
**Color:** Black/ Grey  
**Arrow slot tie**

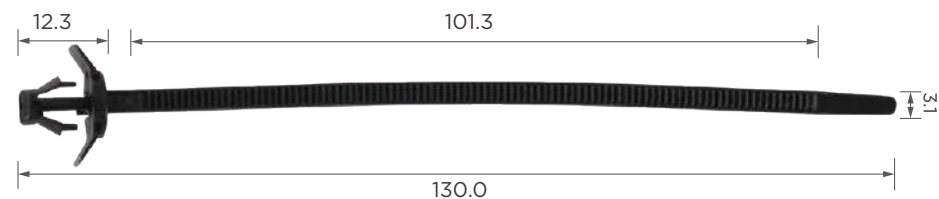

## CABLE TIE

C1333

**Material:** PA  
**Color:** Black  
**Arrow slot tie**



C3352

**Material:** PA  
**Color:** Grey  
**Fir tree on strap**

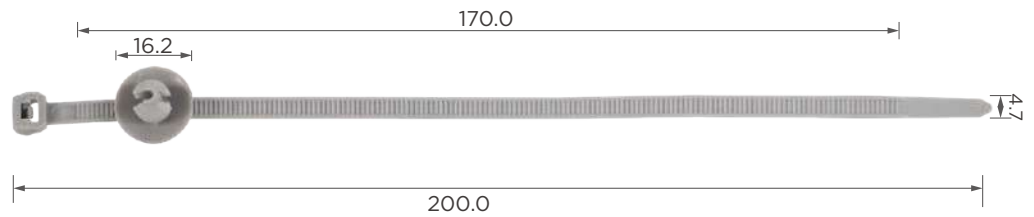

C3358

**Material:** PA  
**Color:** Natural  
**Threaded stud tie**

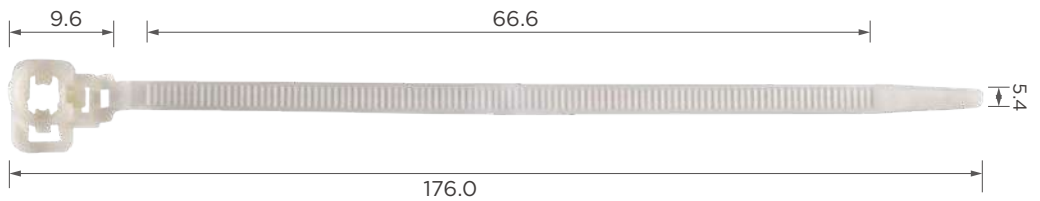

C3440

**Material:** PA  
**Color:** Black  
**Arrow slot tie**



C3501

**Material:** PA+Metal  
**Color:** Black  
**Cable tie with pipe clip**

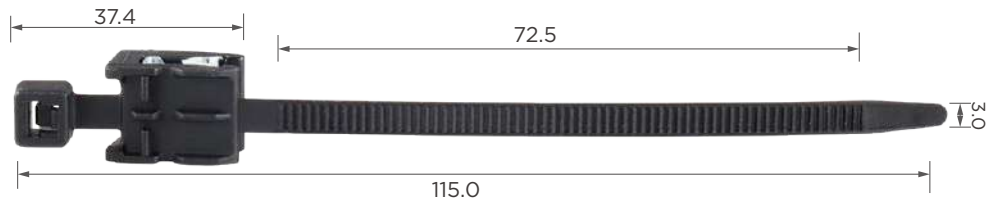

C3578

**Material:** PA  
**Color:** Light Grey  
**Cable tie with pipe clip**



C3580

**Material:** PA  
**Color:** Black  
**Cable tie with pipe clip**

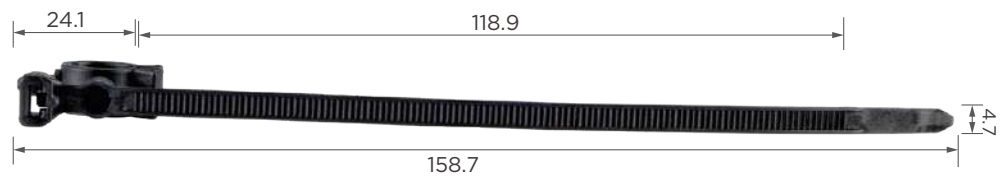



## CABLE TIE

C3587

**Material:** PA  
**Color:** Black  
**Winged arrow head push mount**

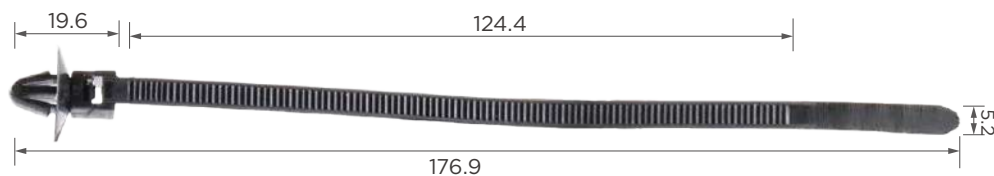

C3747

**Material:** PA  
**Color:** Black  
**Arrow slot tie**

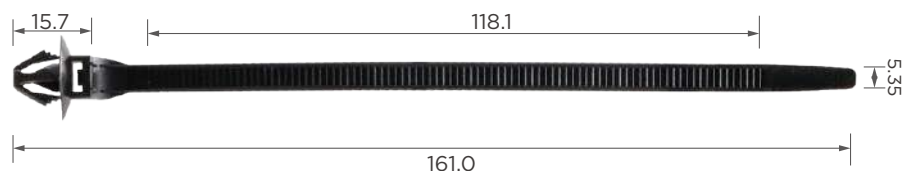

C3818

**Material:** PA  
**Color:** Black  
**Weld stud fixing**

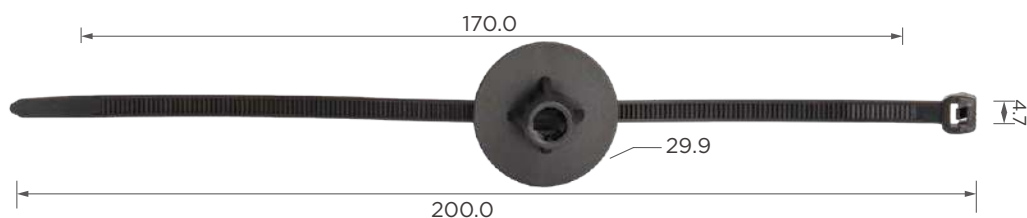

C3821

**Material:** PA  
**Color:** Black  
**Tie wrap with sickle ratchet**



C3913

**Material:** PE  
**Color:** Natural  
**Wire Harness Strap**

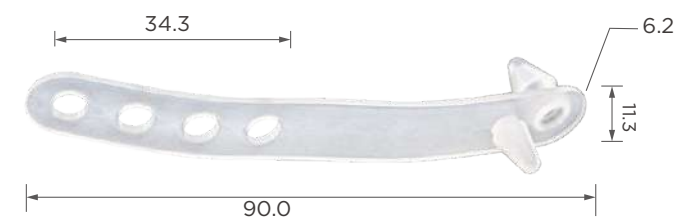

C3914

**Material:** PA  
**Color:** Dark grey  
**Wire Harness Strap**



C3916

**Material:** PE  
**Color:** Black  
**Wire Harness Strap**

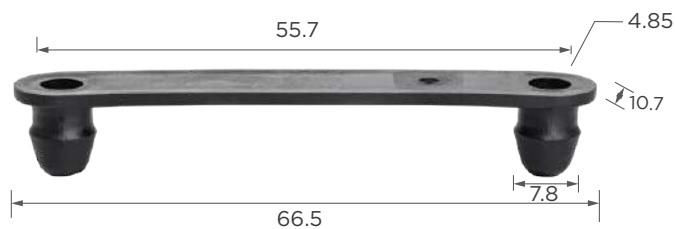

C3917

Material: PA

Color: Black

Wire Harness Strap

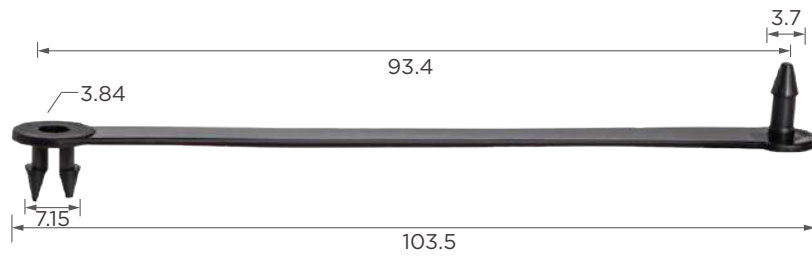

# CABLE & TUBE CLIP

**Product No.:** C0487

**Material:** PA  
**Color:** Black  
**Position:** Tube & cable clip



Product Details

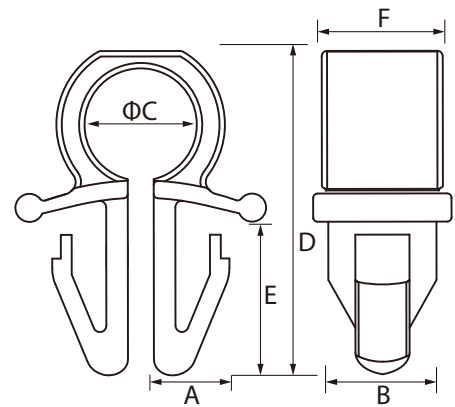

Part No.	Material	Color	mm						in					
			A	B	C	D	E	F	A	B	C	D	E	F
C0051	PA	White	4.10	4.00	9.00	19.00	7.10	5.90	0.160	0.156	0.351	0.741	0.277	0.230
C0487	PA	Black	3.50	5.00	5.10	15.30	7.30	5.65	0.137	0.195	0.199	0.597	0.285	0.220
C0496	PA	Black	4.00	5.70	6.50	21.60	11.30	4.20	0.156	0.222	0.254	0.842	0.441	0.164
C0497	PA	Black	4.15	5.70	9.40	24.10	13.20	4.10	0.162	0.222	0.367	0.940	0.515	0.160
C0498	PA	Black	4.20	5.60	12.80	27.80	10.80	4.00	0.164	0.218	0.499	1.084	0.421	0.156
C0549	PA	Beige	6.90	10.00	7.30	26.15	10.50	10.00	0.269	0.390	0.285	1.020	0.410	0.390
C0667	PA	White	4.00	6.75	5.80	17.40	9.00	7.20	0.156	0.263	0.226	0.679	0.351	0.281
C0884	PA	Black	4.40	5.30	16.00	30.80	11.00	4.00	0.172	0.207	0.624	1.201	0.429	0.156
C1159	PA	Black	4.20	5.10	19.00	33.85	10.90	3.75	0.164	0.199	0.741	1.320	0.425	0.146
C1162	PA	Black	7.00	9.00	6.00	18.45	8.85	10.10	0.273	0.351	0.234	0.720	0.345	0.394
C1252	PA	Green	2.85	5.30	13.55	19.20	8.30	7.80	0.111	0.207	0.528	0.749	0.324	0.304
C1286	PA	Black	2.85	5.80	9.35	14.30	6.70	7.90	0.111	0.226	0.365	0.558	0.261	0.308
C1368	PA	Black	7.70	4.50	11.38	18.10	9.50	10.00	0.300	0.176	0.444	0.706	0.371	0.390
C1400	PA	Black	6.50	4.50	7.00	17.80	9.00	9.40	0.254	0.176	0.273	0.694	0.351	0.367
C1437	PA	White	3.70	5.25	6.70	16.45	6.90	5.90	0.144	0.205	0.261	0.642	0.269	0.230
C1677	PA	Black	4.45	6.59	13.00	24.81	8.50	4.00	0.174	0.257	0.507	0.968	0.332	0.156
C1983	PA	Black	5.30	7.70	5.90	16.40	9.80	6.05	0.207	0.300	0.230	0.640	0.382	0.236
C1989	PA	Black	6.80	9.90	7.90	18.55	9.20	9.90	0.265	0.386	0.308	0.723	0.359	0.386
C1990	PA	Black	6.65	10.15	7.50	18.80	9.85	10.00	0.259	0.396	0.293	0.733	0.384	0.390
C3416	PA	Black	4.60	5.70	8.10	22.20	10.70	5.10	0.179	0.222	0.316	0.866	0.417	0.199

**Product No.:** C0052

**Material:** PA  
**Color:** Black  
**Position:** Tube & cable clip



Product Details

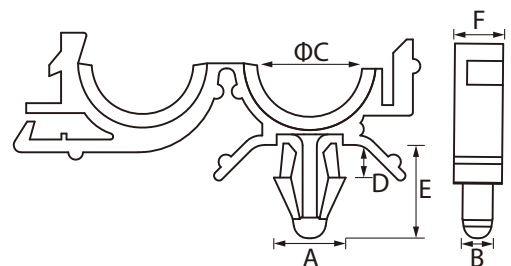

# CABLE & TUBE CLIP

Part No.	Material	Color	mm						in					
			A	B	C	D	E	F	A	B	C	D	E	F
C0052	PA	Black	9.60	5.20	14.00	6.10	14.10	7.70	0.374	0.203	0.546	0.238	0.550	0.300
C0053	PA	Black	9.75	5.10	20.90	5.50	13.55	10.20	0.380	0.199	0.815	0.215	0.528	0.398
C0054	PA	Black	9.60	5.25	12.00	6.05	13.30	7.70	0.374	0.205	0.468	0.236	0.519	0.300
C0059	PA	Black	9.75	5.20	10.35	6.10	13.85	7.70	0.380	0.203	0.404	0.238	0.540	0.300
C0648	PA	Black	7.65	7.40	8.20	2.75	20.40	7.70	0.298	0.289	0.320	0.107	0.796	0.300
C1753	PA	Black	6.00	6.70	6.30	2.20	9.30	10.00	0.234	0.261	0.246	0.086	0.363	0.390
C1903	PA	Black	7.50	7.50	30.20	2.50	9.70	12.00	0.293	0.293	1.178	0.098	0.378	0.468
C3357	PA	Black	10.75	7.80	8.20	3.45	13.50	10.00	0.419	0.304	0.320	0.135	0.527	0.390
C3522	PA	Black	8.35	6.20	35.00	3.15	13.65	13.00	0.326	0.242	1.365	0.123	0.532	0.507

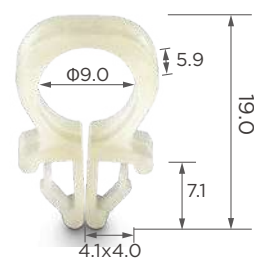

C0051

**Material:** PA  
**Color:** White  
**Rear combination, fuel pump tube**

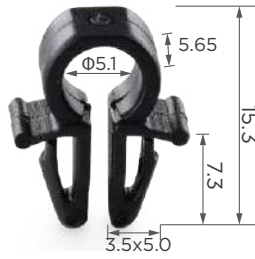

C0487

**Material:** PA  
**Color:** Black  
**Tube & cable clip**

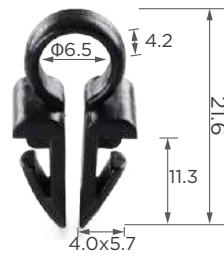

C0496

**Material:** PA  
**Color:** Black  
**Tube & cable clip**



C0497

**Material:** PA  
**Color:** Black  
**Tube & cable clip**



C0498

**Material:** PA  
**Color:** Black  
**Tube & cable clip**

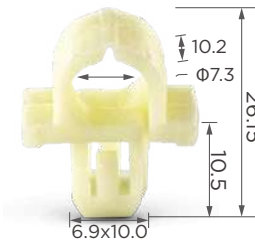

C0549

**Material:** PA  
**Color:** Beige  
**Tube & cable clip**

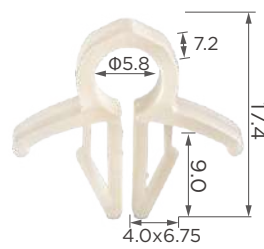

C0667

**Material:** PA  
**Color:** White  
**Hood, handle**

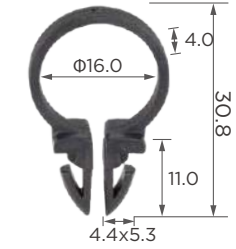

C0884

**Material:** PA  
**Color:** Black  
**Tube & cable clip**

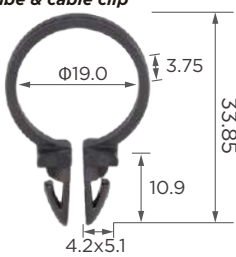

C1159

**Material:** PA  
**Color:** Black  
**Tube & cable clip**



C1162

**Material:** PA  
**Color:** Black  
**Tube & cable clip**

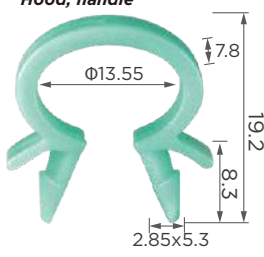

C1252

**Material:** PA  
**Color:** Green  
**Tube & cable clip**



C1286

**Material:** PA  
**Color:** Black  
**Tube & cable clip**

## CABLE & TUBE CLIP

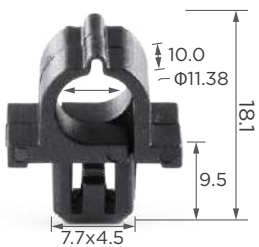

C1368

**Material:** PA  
**Color:** Black  
**Tube & cable clip**



C1400

**Material:** PA  
**Color:** Black  
**Tube & cable clip**

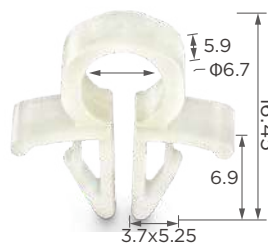

C1437

**Material:** PA  
**Color:** White  
**Tube & cable clip**

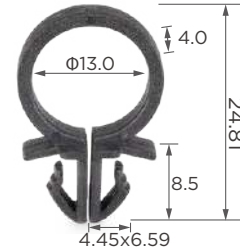

C1677

**Material:** PA  
**Color:** Black  
**Tube & cable clip**



C1983

**Material:** PA  
**Color:** Black  
**Fuel tube**



C1989

**Material:** PA  
**Color:** Black  
**Fuel filler, windshield washer**



C1990

**Material:** PA  
**Color:** Black  
**Hood, fuel filler guard**

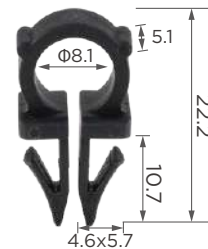

C3416

**Material:** PA  
**Color:** Black  
**Tube & cable routing clip**



C0052

**Material:** PA  
**Color:** Black  
**Tube & cable clip**



C0053

**Material:** PA  
**Color:** Black  
**Tube & cable clip**

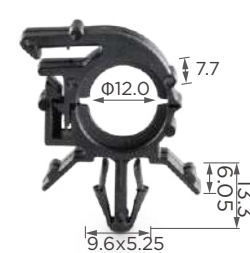

C0054

**Material:** PA  
**Color:** Black  
**Harness, battery cable**



C0059

**Material:** PA  
**Color:** Black  
**Battery cable, brake system, fuel supply system**



C0648

**Material:** PA  
**Color:** Black  
**Brake system**

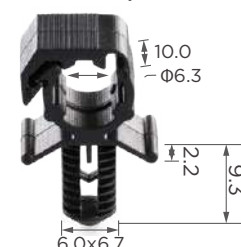

C1753

**Material:** PA  
**Color:** Black  
**Tube & cable clip**



C1903

**Material:** PA  
**Color:** Black  
**Tube & cable clip**



C3357

**Material:** PA  
**Color:** Black  
**Tube & cable clip**

# CABLE & TUBE CLIP



C3522

**Material:** PA  
**Color:** Black  
**Tube & cable clip**



## 01. Brake Line Pipe Mounting Holder Clip

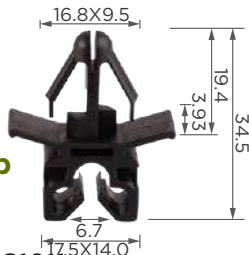

C1011

**Material:** POM  
**Color:** Black  
**Tube & cable routing clip**

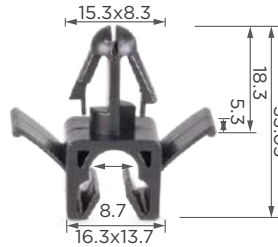

C1016

**Material:** POM  
**Color:** Black  
**Tube & cable routing clip**



C1377

**Material:** Nylon  
**Color:** Black  
**Tube & cable clip**

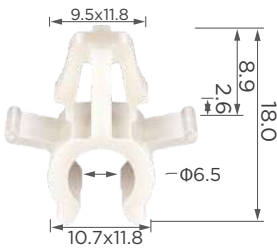

C3032

**Material:** PA  
**Color:** Natural  
**Tube & cable clip**



C3289

**Material:** PA  
**Color:** Black  
**Tube & cable clip**

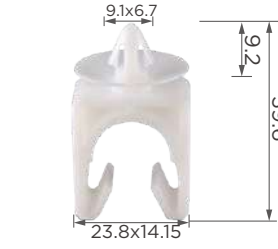

C3514

**Material:** POM  
**Color:** White  
**Tube & cable clip**



C3515

**Material:** POM  
**Color:** White  
**Tube & cable clip**



C3699

**Material:** PA  
**Color:** Black  
**Tube & cable clip**

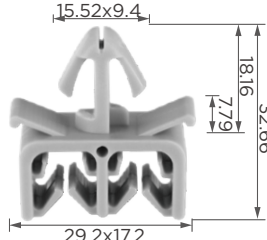

C1012

**Material:** PA  
**Color:** Grey  
**Tube & cable routing clip**



C1015

**Material:** POM  
**Color:** Black  
**Tube & cable routing clip**

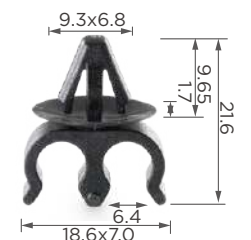

C1380

**Material:** PA  
**Color:** Black  
**Tube & cable clip**



## CABLE & TUBE CLIP

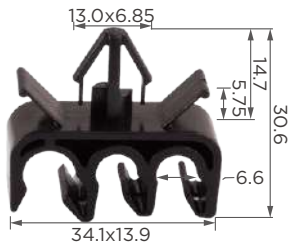

C1008

**Material:** POM  
**Color:** Black  
**Tube & cable routing clip**

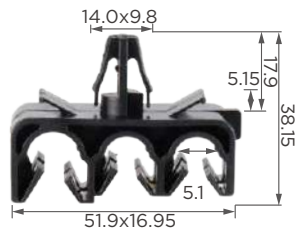

C1014

**Material:** POM  
**Color:** Black  
**Tube & cable routing clip**

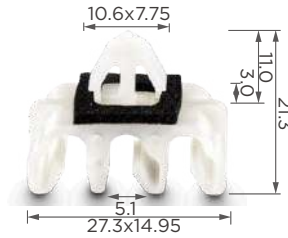

C1371

**Material:** POM  
**Color:** White  
**Tube & cable clip**

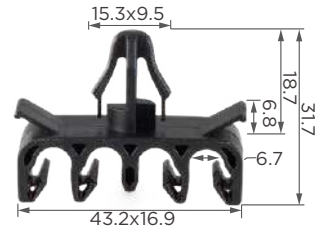

C1018

**Material:** POM  
**Color:** Black  
**Tube & cable routing clip**



C3692

**Material:** POM  
**Color:** Black  
**Side load luggage retention**



C3817

**Material:** POM  
**Color:** Black  
**Cable holding**

## 02. In-air Cable Clip



C1231

**Material:** POM  
**Color:** Black  
**Tube & cable clip**

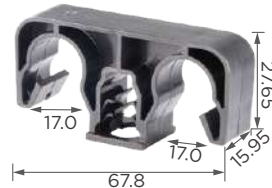

C1024

**Material:** POM  
**Color:** Black  
**Tube & cable routing clip**



C1042

**Material:** POM  
**Color:** Black  
**Tube & cable routing clip**

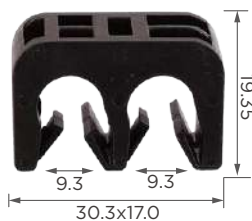

C1210

**Material:** POM  
**Color:** Black  
**Tube & cable routing clip**



C1025

**Material:** PA  
**Color:** Brown  
**Tube & cable routing clip**



C1026

**Material:** PA  
**Color:** Black  
**Tube & cable routing clip**

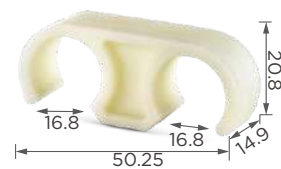

C1027

**Material:** PA  
**Color:** White  
**Tube & cable routing clip**



C1030

**Material:** PA  
**Color:** Black  
**Tube & cable routing clip**

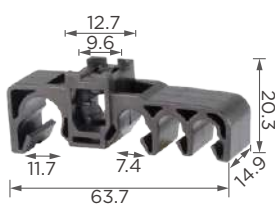

C1013

**Material:** POM  
**Color:** Black  
**Tube & cable routing clip**



C1019

**Material:** POM  
**Color:** Black  
**Tube & cable routing clip**



C1020

**Material:** POM  
**Color:** Black  
**Tube & cable routing clip**

# CABLE & TUBE CLIP



**C1043**  
**Material:** POM  
**Color:** Black  
*Tube & cable routing clip*

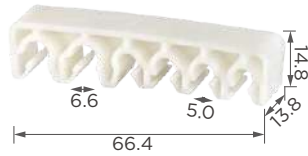

**C1205**  
**Material:** POM  
**Color:** White  
*Tube & cable routing clip*



**C1206**  
**Material:** POM  
**Color:** White  
*Tube & cable routing clip*

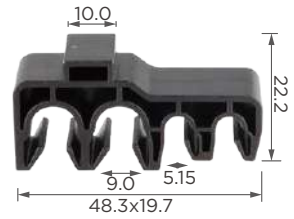

**C1211**  
**Material:** POM  
**Color:** Black  
*Tube & cable routing clip*



**C1230**  
**Material:** POM  
**Color:** Black  
*Tube & cable clip*



**C1376**  
**Material:** POM  
**Color:** White  
*Tube & cable clip*

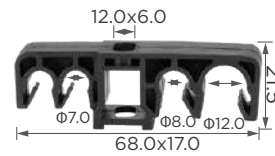

**C3538**  
**Material:** POM  
**Color:** Black  
*Tube & cable clip*

## 03. Brake Hydraulic Line Clip

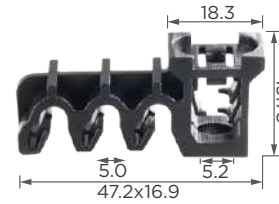

**C1203**  
**Material:** POM  
**Color:** Black  
*Tube & cable routing clip*

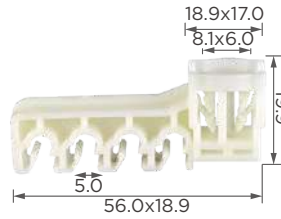

**C1204**  
**Material:** POM  
**Color:** White  
*Tube & cable routing clip*



**C1208**  
**Material:** POM  
**Color:** Black  
*Tube & cable routing clip*

## 04. In-air Cable Clip

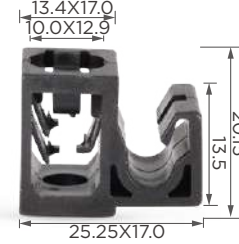

**C1010**  
**Material:** POM  
**Color:** Black  
*Tube & cable routing clip*

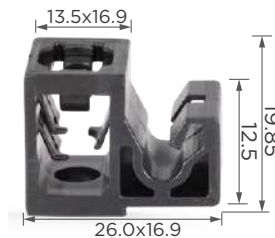

**C1207**  
**Material:** POM  
**Color:** Black  
*Tube & cable routing clip*

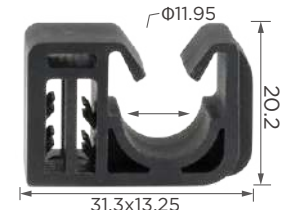

**C3518**  
**Material:** POM  
**Color:** Black  
*Tube & cable clip*

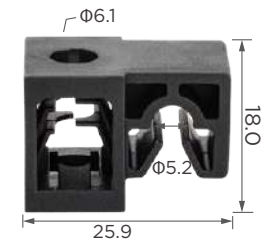

**C3794**  
**Material:** PA  
**Color:** Black  
*Tube & cable clip*

# CABLE & TUBE CLIP

## 05. Self-adhesive Cable Clip

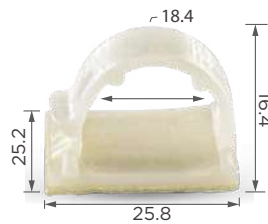

C0220

**Material:** PA  
**Color:** White  
**Cable clip**



C0250

**Material:** PA  
**Color:** White  
**Cable support**

## 06. Drive Rivet Cable Clip



C0923

**Material:** PA  
**Color:** Beige  
**Hood prop rod support**



C0940

**Material:** PA  
**Color:** Dark Grey  
**Hood prop rod support, rear tray**

## 07. Hood Prop Rod Support Clip

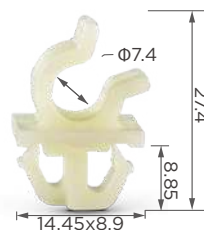

C0050

**Material:** PA  
**Color:** White  
**Hood prop rod support**

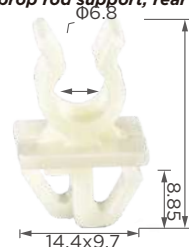

C0811

**Material:** PA  
**Color:** Beige  
**Hood prop rod support**

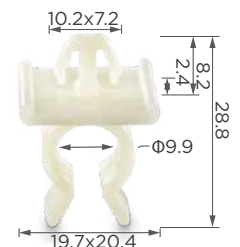

C0488

**Material:** PA  
**Color:** Beige  
**Hood prop rod support**

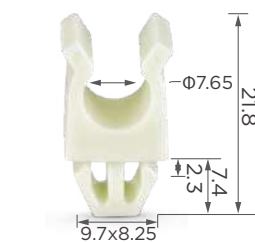

C1875

**Material:** PA  
**Color:** Light green  
**Hood prop rod support**

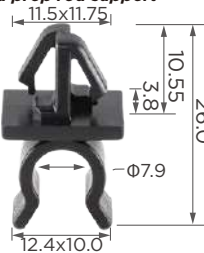

C3467

**Material:** POM  
**Color:** Black  
**Hood prop rod support**



C3956

**Material:** POM  
**Color:** Black  
**Hood rod holder**

## 08. 2-Hold Hinged Locking Cable Clamp



C1905

**Material:** PA  
**Color:** Black  
**Tube & cable clip**



C3500

**Material:** PA  
**Color:** Black  
**Hood prop rod support**

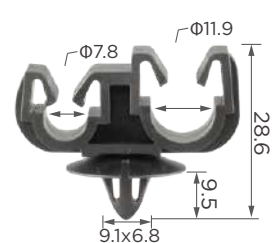

C3516

**Material:** POM  
**Color:** Black  
**Tube & cable clip**

# CABLE & TUBE CLIP

## 09. Hood Rod Clip

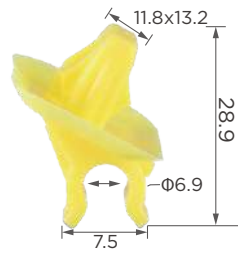

C3564

**Material:** POM  
**Color:** Yellow  
**Tube & cable clip**

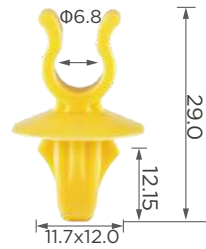

C3572

**Material:** POM  
**Color:** Yellow  
**Tube & cable clip**



C3939

**Material:** PA  
**Color:** Yellow  
**Hood rod holder**

## 10. Push-in Round Hole Mounting Clip



C0502

**Material:** PA  
**Color:** Black  
**Side moulding, rear panel**



C1169

**Material:** PA  
**Color:** Black  
**Tube & cable routing clip**



C1192

**Material:** PA  
**Color:** Black  
**Tube & cable routing clip**



C1331

**Material:** PA  
**Color:** Black  
**Hood prop rod support, fuel supply system**



C3021

**Material:** POM  
**Color:** Black  
**Hood prop rod support**



C3031

**Material:** PA  
**Color:** Black  
**Hood prop rod support**



C3069

**Material:** PA  
**Color:** Black  
**Hood prop rod support**



C3293

**Material:** PA  
**Color:** Black  
**Door panel**

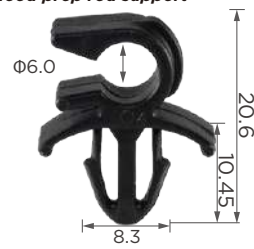

C3567

**Material:** POM  
**Color:** Black  
**Tube & cable clip**

## 11. R-Type Metal Clamp with Pipe Clip

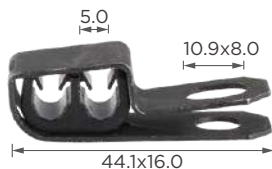

C1209

**Material:** POM  
**Color:** Black  
**Tube & cable routing clip**



C1213

**Material:** POM  
**Color:** Black  
**Tube & cable routing clip**



C1223

**Material:** POM  
**Color:** Black  
**Tube & cable clip**

## CABLE & TUBE CLIP

### 12. Brake Pipe Clip



C1017

**Material:** POM  
**Color:** Black  
**Tube & cable routing clip**



C1009

**Material:** POM  
**Color:** Black  
**Tube & cable routing clip**



C3384

**Material:** POM  
**Color:** Black  
**Tube & cable clip**

### 13. Rod Wire Cable Loom Clip



C1163

**Material:** PA  
**Color:** Black  
**Tube & cable routing clip**



C1165

**Material:** PA  
**Color:** Black  
**Tube & cable routing clip**

### 14. Wire Cable Clip



C1800

**Material:** PA  
**Color:** Black  
**Tube & cable clip**

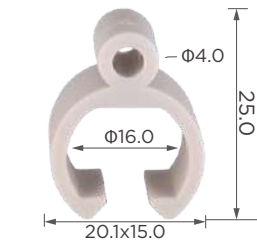

C1904

**Material:** PA  
**Color:** Grey  
**Tube & cable clip**

### 15. Bonnet Support Rod Clip

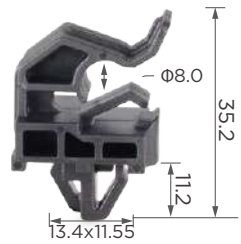

C1960

**Material:** PA  
**Color:** Black  
**Hood prop rod support**



C1962

**Material:** PA  
**Color:** Black  
**Hood prop rod support**

### 16. Bonnet Clips



C1155

**Material:** POM  
**Color:** Black  
**Tube & cable routing clip**



C1802

**Material:** PA  
**Color:** Black  
**Tube & cable clip**

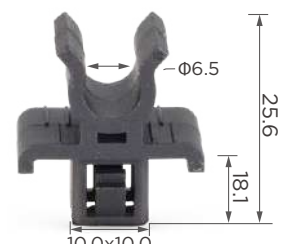

C3199

**Material:** PA  
**Color:** Black  
**Tube & cable clip**



## CABLE & TUBE CLIP

### 17. Push-in Pipe Clip

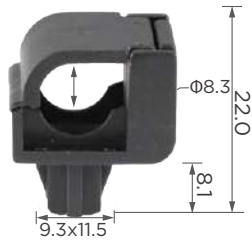

C1312

**Material:** PA  
**Tube & cable clip**



C1358

**Material:** PA  
**Color:** Black  
**Tube & cable clip**



C1900

**Material:** PA  
**Color:** Black  
**Tube & cable clip**

### 18. Fir Tree Cable Clip



C1813

**Material:** PA  
**Color:** Black  
**Tube & cable clip**

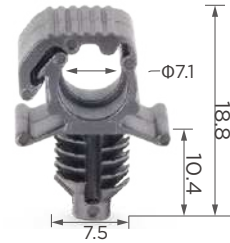

C1906

**Material:** PA  
**Color:** Black  
**Tube & cable clip**

### 19. Other Cable Clips

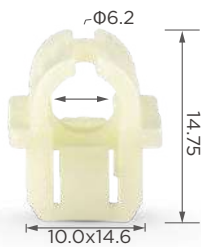

C0113

**Material:** PA  
**Color:** Beige  
**Headlight**



C0171

**Material:** POM  
**Color:** Black  
**Hood prop rod support**

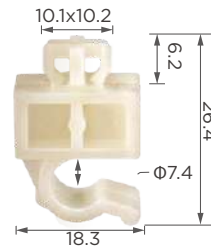

C0231

**Material:** PA  
**Color:** White  
**Hood prop rod support**

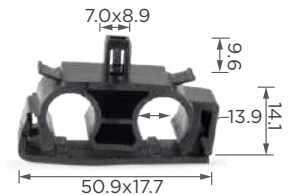

C1028

**Material:** PA  
**Color:** Black  
**Tube & cable routing clip**



C1029

**Material:** PA  
**Color:** Black  
**Tube & cable routing clip**



C1044

**Material:** POM  
**Color:** Black  
**Tube & cable routing clip**



C1057

**Material:** POM  
**Color:** Black  
**Tube & cable routing clip**



C1108

**Material:** PA  
**Color:** Black  
**Tube & cable routing clip**



# CABLE & TUBE CLIP



**C1212**  
**Material:** POM  
**Color:** Black  
**Tube & cable routing clip**



**C1671**  
**Material:** POM  
**Color:** Black  
**Tube & cable clip**

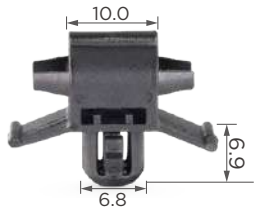

**C1924**  
**Material:** PA  
**Color:** Black  
**Hood prop rod support, Rear panel**

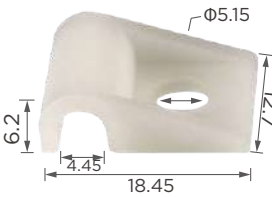

**C3604**  
**Material:** PA  
**Color:** White  
**Tube & cable clip**

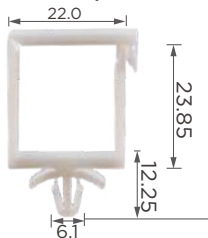

**C3936**  
**Material:** PA  
**Color:** Natural  
**Wire Saddle**

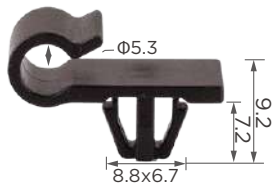

**C1332**  
**Material:** POM  
**Color:** Black  
**Tube & cable clip**



**C1672**  
**Material:** PA  
**Color:** Black  
**Tube & cable clip**



**C3378**  
**Material:** POM  
**Color:** Black  
**Front bumper**

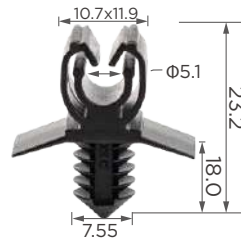

**C3750**  
**Material:** POM  
**Color:** Black  
**Tube & cable clip**

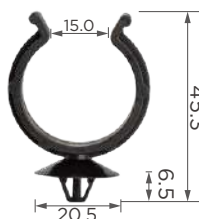

**C3988**  
**Material:** PA  
**Color:** Black  
**Cable holding**

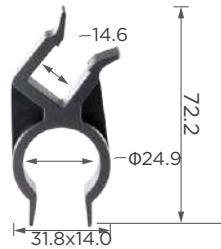

**C1367**  
**Material:** PA  
**Color:** Black  
**Tube & cable routing clip**



**C1752**  
**Material:** PA  
**Color:** Black  
**Tube & cable clip**

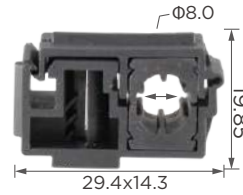

**C3520**  
**Material:** PA  
**Color:** Black  
**Tube & cable clip**



**C3798**  
**Material:** PA  
**Color:** Natural  
**Tube & cable clip**

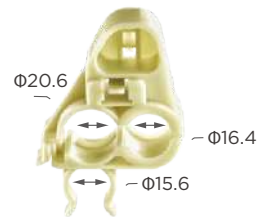

**C1493**  
**Material:** POM  
**Color:** Light green  
**Tube & cable clip**



**C1847**  
**Material:** POM  
**Color:** Black  
**Hood prop rod support**

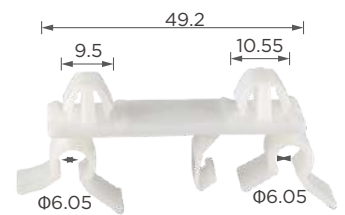

**C3566**  
**Material:** POM  
**Color:** White  
**Pillar, tube & cable clip**

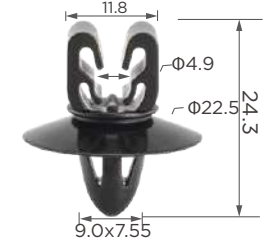

**C3814**  
**Material:** POM  
**Color:** Black  
**Tube & cable clip**

# HOLE PLUG BUTTON

**Product No.:** C1807

**Material:** PE  
**Color:** Black  
**Position:** Door panel



Product Details

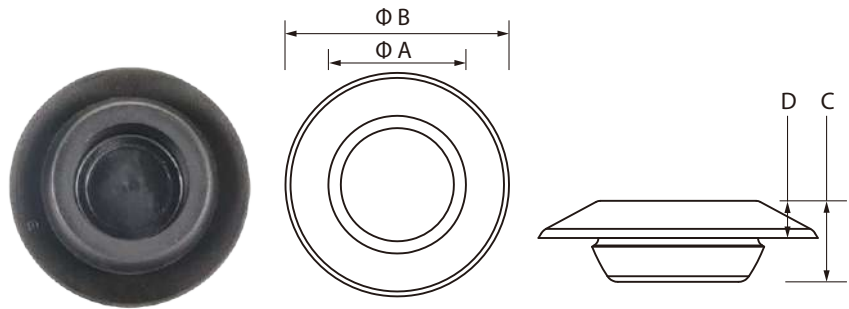

Part No.	Material	Color	Position	mm				in			
				A	B	C	D	A	B	C	D
C0304	PE	Black	Hole plug	19.70	29.35	8.85	4.30	0.768	1.145	0.345	0.168
C0305	PE	Black	Hole plug	13.80	22.40	6.40	2.70	0.538	0.874	0.250	0.105
C0306	PE	Black	Hole plug	13.50	22.20	5.90	1.00	0.527	0.866	0.230	0.039
C0307	PE	Black	Hole plug	10.20	18.90	6.10	2.60	0.398	0.737	0.238	0.101
C0308	PE	Black	Hole plug	19.65	25.30	6.50	3.00	0.766	0.987	0.254	0.117
C0343	PE	Black	Hole plug	23.30	29.00	6.35	3.10	0.909	1.131	0.248	0.121
C1041	PE	Black	Body plug	24.10	30.00	5.60	2.20	0.940	1.170	0.218	0.086
C1807	PE	Black	Door panel	18.80	25.75	7.30	2.80	0.733	1.004	0.285	0.109
C3068	TPU	Black	Door oanel, rear windshield, body plug	23.50	29.45	9.00	5.33	0.917	1.149	0.351	0.208
C3226	TPE	Black	Floor plug, body plug	13.50	16.80	5.95	2.05	0.527	0.655	0.232	0.080
C3232	TPU	Black	Pillar garnish, body plug	20.40	30.10	8.05	2.90	0.796	1.174	0.314	0.113
C3235	TPU	Black	Pillar garnish, body plug	31.75	39.75	7.55	3.00	1.238	1.550	0.294	0.117
C3249	TPE	Black	Body plug	13.00	20.10	7.60	3.10	0.507	0.784	0.296	0.121
C3251	TPE	Black	Body plug	16.90	21.80	7.90	2.60	0.659	0.850	0.308	0.101
C3266	TPE	Black	Rocker panel, side moulding, body plug	13.30	22.00	7.50	3.40	0.519	0.858	0.293	0.133
C3330	TPE	Black	Body plug	16.70	23.10	7.90	3.80	0.651	0.901	0.308	0.148
C3460	TPE	Black	Body plug	21.40	29.30	9.40	3.10	0.835	1.143	0.367	0.121
C3468	PE	Black	Body plug	21.10	29.00	8.45	2.80	0.823	1.131	0.330	0.109
C3562	TPV	Black	Body plug	34.10	45.00	10.05	3.90	1.330	1.755	0.392	0.152
C3586	PP	Black	Body plug	21.10	29.00	7.89	2.65	0.823	1.131	0.308	0.103
C3593	PE	Black	Body plug	12.00	19.00	7.65	3.10	0.468	0.741	0.298	0.121
C3595	TPV	Black	Body plug	26.20	34.00	7.50	4.00	1.022	1.326	0.293	0.156
C3597	PP	Black	Body plug	15.80	22.90	7.50	3.10	0.616	0.893	0.293	0.121
C3600	TPE	Black	Body plug	27.70	33.00	9.90	4.90	1.080	1.287	0.386	0.191
C3601	PE	Dark grey	Body plug	7.60	15.00	7.60	3.00	0.296	0.585	0.296	0.117
C3602	TPV	Black	Body plug	49.8x34.6	39.8x24.75	16.15	4.30	1.94x1.35	1.55x0.965	0.630	0.168
C3823	TPE	Black	Door panel plug	32.60	50.80	10.30	4.80	1.271	1.981	0.402	0.187

# — HOLE PLUG BUTTON



**C0304**

**Material:** PE  
**Color:** Black  
**Hole plug**



**C0305**

**Material:** PE  
**Color:** Black  
**Hole plug**



**C0306**

**Material:** PE  
**Color:** Black  
**Hole plug**



**C0307**

**Material:** PE  
**Color:** Black  
**Hole plug**



**C0308**

**Material:** PE  
**Color:** Black  
**Hole plug**



**C0343**

**Material:** PE  
**Color:** Black  
**Hole plug**



**C1041**

**Material:** PE  
**Color:** Black  
**Body plug**



**C1807**

**Material:** PE  
**Color:** Black  
**Door panel**



**C3068**

**Material:** TPU  
**Color:** Black  
**Door panel, rear windshield, body plug**



**C3226**

**Material:** TPE  
**Color:** Black  
**Floor plug, body plug**



**C3232**

**Material:** TPU  
**Color:** Black  
**Pillar garnish, body plug**



**C3235**

**Material:** TPU  
**Color:** Black  
**Pillar garnish, body plug**



**C3249**

**Material:** TPE  
**Color:** Black  
**Body plug**



**C3251**

**Material:** TPE  
**Color:** Black  
**Body plug**



**C3266**

**Material:** TPE  
**Color:** Black  
**Rocker panel, side moulding, body plug**



**C3330**

**Material:** TPE  
**Color:** Black  
**Body plug**

# HOLE PLUG BUTTON



**C3460**

**Material:** TPE  
**Color:** Black  
**Body plug**



**C3468**

**Material:** PE  
**Color:** Black  
**Body plug**



**C3562**

**Material:** TPV  
**Color:** Black  
**Body plug**



**C3586**

**Material:** PP  
**Color:** Black  
**Body plug**



**C3593**

**Material:** PE  
**Color:** Black  
**Body plug**



**C3595**

**Material:** TPV  
**Color:** Black  
**Body plug**



**C3597**

**Material:** PP  
**Color:** Black  
**Body plug**



**C3600**

**Material:** TPE  
**Color:** Black  
**Body plug**



**C3601**

**Material:** PE  
**Color:** Dark grey  
**Body plug**



**C3602**

**Material:** TPV  
**Color:** Black  
**Body plug**



**C3823**

**Material:** TPE  
**Color:** Black  
**Door panel plug**

## DOOR TRIM PANEL CLIP

**Product No.:** C1226

**Material:** POM  
**Color:** Black  
**Position:** Door panel, rocker panel



Product Details

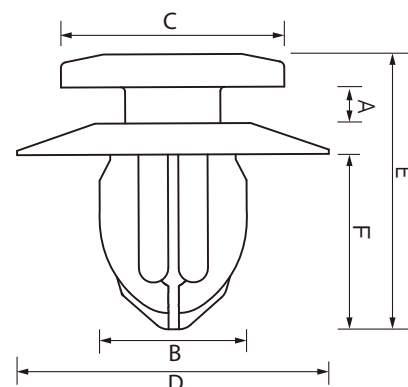

Part No.	Material	Color	mm						in					
			A	B	C	D	E	F	A	B	C	D	E	F
C1643	POM	Black	0.90	8.00	10.00	12.25	12.90	8.70	0.035	0.312	0.390	0.478	0.503	0.339
C0691	PA	White	1.10	12.1x8.2	12.85	19.80	16.30	10.70	0.043	0.472x0.320	0.501	0.772	0.636	0.417
C1281	PA	Black	1.20	10.55x6.0	13.0x6.5	17.90	17.95	11.25	0.047	0.411x0.234	0.507x0.254	0.698	0.700	0.439
C0961	POM	Blue	1.25	9.10	13.20	18.10	20.45	12.10	0.049	0.355	0.515	0.706	0.798	0.472
C1470	PA	Natural	1.30	6.9x4.4	12.5x13.9	14.00	12.70	8.00	0.051	0.269x0.172	0.488x0.542	0.546	0.495	0.312
C0943	PA	White	1.30	9.45x8.85	10.80	18.15	16.55	11.85	0.051	0.369x0.345	0.421	0.708	0.645	0.462
C1279	POM	White	1.30	9.45	14.80	18.10	18.10	12.25	0.051	0.369	0.577	0.706	0.706	0.478
C0258	POM	White	1.35	7.75x7.75	12.00	16.10	25.50	13.30	0.053	0.302x0.302	0.468	0.628	0.995	0.519
C3033	POM	Yellow	1.50	7.80	13.5x13.5	17.20	18.70	13.40	0.059	0.304	0.527x0.527	0.671	0.729	0.523
C3318	POM	Red	1.50	9.90	13.4x13.4	17.30	19.20	13.90	0.059	0.386	0.527x0.527	0.675	0.749	0.542
C1379	POM	Blue	1.55	6.8x7.8	10.70	14.40	16.80	12.20	0.060	0.265x0.304	0.417	0.562	0.655	0.476
C1950	POM	Grey	1.60	9.3x7.8	13.15	16.10	16.30	12.60	0.062	0.363x0.304	0.513	0.628	0.636	0.491
C1894	POM	Yellow	1.60	9.65x8.85	10.15x10.1	16.00	18.55	14.05	0.062	0.376x0.345	0.396x0.394	0.624	0.723	0.548
C1598	POM	White	1.65	8.0x7.7	9.8x10.35	15.10	13.25	7.45	0.064	0.312x0.300	0.382x0.404	0.589	0.517	0.291
C3324	POM	Natural	1.70	9.2x7.4	13.00	16.00	16.25	12.55	0.066	0.359x0.289	0.507	0.624	0.634	0.489
C1691	POM	White	1.70	9.50	13.20	15.70	15.10	10.90	0.066	0.371	0.515	0.612	0.589	0.425
C1321	POM	Black	1.70	9.9x8.1	13.10	13.10	14.05	8.70	0.066	0.386x0.316	0.511	0.511	0.548	0.339
C1975	POM	White	1.70	11.3x9.75	17.9x14.5	18.50	18.30	10.95	0.066	0.441x0.380	0.698x0.566	0.722	0.714	0.427
C3070	POM	Grey	1.75	7.85x5.25	13.00	10.65	14.70	9.25	0.068	0.306x0.205	0.507	0.415	0.573	0.361
C1695	POM	Black	1.75	10.2x6.0	13.00	18.05	22.35	14.10	0.068	0.398x0.234	0.507	0.704	0.872	0.550
C1762	POM	Natural	1.75	10.4x8.0	11.9x10.65	15.25x9.8	17.05	12.55	0.068	0.406x0.312	0.464x0.415	0.595x0.382	0.665	0.489
C1702	POM	White	1.80	11.65x10.8	12.0x6.6	16.00	14.80	10.45	0.070	0.454x0.421	0.468x0.257	0.624	0.577	0.408
C1726	POM	White	1.85	9.50	13.00	18.00	17.93	11.45	0.072	0.371	0.507	0.702	0.699	0.447
C3220	POM	Natural	1.85	9.9x8.8	14.0x10.45	15.85	16.10	11.50	0.072	0.386x0.343	0.546x0.408	0.618	0.628	0.449
C0935	PA	White	1.90	8.3x5.45	12.1x14.0	16.30	16.50	11.20	0.074	0.324x0.213	0.472x0.546	0.636	0.644	0.437
C0819	POM	White	1.90	8.70	12.20	16.20	30.00	24.40	0.074	0.339	0.476	0.632	1.170	0.952
C0369	POM	White	1.90	8.74	12.25	16.00	17.10	11.10	0.074	0.341	0.478	0.624	0.667	0.433
C1436	POM	Grey	1.90	9.6x5.6	11.3x19.7	21.00	15.85	10.50	0.074	0.374x0.218	0.441x0.768	0.819	0.618	0.410
C1995	POM	Yellow	1.90	9.6x7.8	13.00	16.60	16.80	10.10	0.074	0.374x0.304	0.507	0.647	0.655	0.394

## DOOR TRIM PANEL CLIP

Part No.	Material	Color	mm						in					
			A	B	C	D	E	F	A	B	C	D	E	F
C1416A	POM	Black	1.90	10.15	16.00	16.00	15.20	9.30	0.074	0.396	0.624	0.624	0.593	0.363
C1478	POM	White	1.90	10.65x8.1	10.1x12.35	17.80	16.90	11.70	0.074	0.415x0.316	0.394x0.482	0.694	0.659	0.456
C3313	POM	Natural	1.90	11.60	13.20	19.00	22.55	17.15	0.074	0.452	0.515	0.741	0.879	0.669
C1345	POM	Yellow	1.95	9.90	13.25	18.15	22.40	13.90	0.076	0.386	0.517	0.708	0.874	0.542
C3015	POM	Natural	1.95	10.65x7.65	8.00	12.15	16.05	9.20	0.076	0.415x0.298	0.312	0.474	0.626	0.359
C0166	PA	White	2.00	9.65x5.8	7.8x7.8	15.45	14.65	6.55	0.078	0.376x0.226	0.304x0.304	0.603	0.571	0.255
C0356	POM	Yellow	2.00	9.6x5.85	7.8x7.8	16.00	14.60	9.60	0.078	0.374x0.228	0.304x0.304	0.624	0.569	0.374
C0382	POM	White	2.00	9.60	12.90	18.10	17.15	11.00	0.078	0.374	0.503	0.706	0.669	0.429
C0813	POM	Red	2.00	10.6x8.35	12.90	18.00	16.70	10.70	0.078	0.413x0.326	0.503	0.702	0.651	0.417
C0992	POM	Black	2.00	9.6x6.75	17.10	17.05	17.50	12.15	0.078	0.374x0.263	0.667	0.665	0.683	0.474
C1114	POM	White	2.00	11.3x5.45	10.8x15.5	16.00	16.70	12.50	0.078	0.441x0.213	0.421x0.605	0.624	0.651	0.488
C1226	POM	Black	2.00	9.25x8.4	12.85	18.00	16.00	10.20	0.078	0.361x0.328	0.501	0.702	0.624	0.398
C1402	POM	Light grey	2.00	9.30	13.00	16.40	18.00	11.40	0.078	0.363	0.507	0.640	0.702	0.445
C1497	POM	Natural	2.00	12.3x8.0	9.8x7.9	20.00	15.90	8.95	0.078	0.480x0.312	0.382x0.308	0.780	0.620	0.349
C1576	POM	Black	2.00	9.40	13.20	18.00	16.40	11.10	0.078	0.367	0.515	0.702	0.640	0.433
C1795	POM	Yellow	2.00	9.3x7.75	13.20	17.05	18.05	11.85	0.078	0.363x0.302	0.515	0.665	0.704	0.462
C1916	POM	Natural	2.00	7.9x7.15	12.00	15.95	15.60	9.95	0.078	0.308x0.279	0.468	0.622	0.608	0.388
C3083	POM	White/ Green	2.00	9.25	12.95	17.40	19.60	13.65	0.078	0.361	0.505	0.679	0.764	0.532
C3089	POM+PA	White +Black	2.00	7.90	13.10	17.40	15.40	11.40	0.078	0.308	0.511	0.679	0.601	0.445
C3087	POM	White	2.05	10.6x7.9	15.0x16.95	16.05x9.05	17.15	11.05	0.080	0.413x0.308	0.585x0.661	0.626x0.353	0.669	0.431
C1294	PA	Black	2.10	11.3x7.75	10.15x8.1	10.0x14.1	15.75	11.35	0.082	0.441x0.302	0.396x0.316	0.390x0.550	0.614	0.443
C1410	POM	White	2.10	10.85x7.3	13.15x16.3	14.00	21.40	13.20	0.082	0.423x0.285	0.512x0.636	0.546	0.835	0.515
C1461	POM	Pink	2.10	9.7x8.6	11.2x13.9	17.15	17.70	11.00	0.082	0.378x0.335	0.437x0.542	0.669	0.690	0.429
C1907	POM	Grey	2.10	10.5x7.7	7.80	17.70	12.60	4.50	0.082	0.410x0.300	0.304	0.690	0.491	0.176
C3778	POM	Beige	2.10	9.55	13.05	16.00	16.70	12.10	0.082	0.372	0.509	0.624	0.651	0.472
C3784	POM	Natural	2.10	8.85x8.6	12.70	17.60	16.00	10.30	0.082	0.345x0.335	0.495	0.686	0.624	0.402
C0061	PA	White	2.15	11.6x7.7	14.05	18.50	19.30	13.75	0.084	0.452x0.300	0.548	0.722	0.753	0.536
C1645	POM	Yellow	2.15	10.6x7.6	13.20	18.20	17.35	11.60	0.084	0.413x0.296	0.515	0.710	0.677	0.452
C1811	POM	White	2.15	7.85x7.75	13.20	17.00	18.15	11.80	0.084	0.306x0.302	0.515	0.663	0.708	0.460
C1862	POM	Green	2.15	9.40	13.00	17.90	18.50	11.70	0.084	0.367	0.507	0.698	0.722	0.456
C1949	PA	Grey	2.15	9.5x9.6	13.00	16.40	19.20	12.15	0.084	0.371x0.374	0.507	0.640	0.749	0.474
C3656	PA	Red	2.15	10.60	13.05	18.65	20.10	14.60	0.084	0.413	0.509	0.727	0.784	0.569
C0876	POM	White	2.20	9.6x8.15	13.00	16.70	17.75	11.10	0.086	0.374x0.318	0.507	0.651	0.692	0.433
C1339	POM	White	2.20	9.4x7.1	11.5x18.7	20.80	17.30	12.00	0.086	0.449x0.277	0.449x0.729	0.811	0.675	0.468
C1460	POM	Pink	2.20	8.5x5.1	13.00	18.50	16.00	9.80	0.086	0.332x0.199	0.507	0.722	0.624	0.382
C1656	POM	White	2.20	11.6x8.1	12.45	18.00	16.15	8.65	0.086	0.452x0.316	0.486	0.702	0.630	0.337
C1717	POM	Black	2.20	9.85x5.1	13.95x10.85	17.05	17.30	11.40	0.086	0.384x0.199	0.544x0.423	0.665	0.675	0.445
C1782	POM	White	2.20	8.6x5.4	11.8x7.65	15.95	13.05	8.45	0.086	0.335x0.211	0.460x0.298	0.622	0.509	0.330
C1831	PA	Brown	2.20	9.55	13.60	18.00	19.75	14.40	0.086	0.372	0.530	0.702	0.770	0.562
C1877	POM	Black	2.20	12.2x8.0	12.99	18.00	17.80	11.70	0.086	0.476x0.312	0.507	0.702	0.694	0.456
C3042	POM	Green	2.20	9.7x8.1	13.05	18.10	16.55	9.35	0.086	0.378x0.316	0.509	0.706	0.645	0.365
C3238	POM	Natural	2.20	8.00	9.55	12.10	13.10	8.90	0.086	0.312	0.372	0.472	0.511	0.347
C1616	POM	Yellow	2.25	10.3x5.7	15.0x12.55	17.60	20.50	12.30	0.088	0.402x0.222	0.585x0.489	0.686	0.800	0.480



## DOOR TRIM PANEL CLIP

Part No.	Material	Color	mm						in					
			A	B	C	D	E	F	A	B	C	D	E	F
C1709	POM	White	2.25	9.5x8.5	13.05	16.05	15.70	11.15	0.088	0.371x0.332	0.509	0.626	0.612	0.435
C1833	POM	Natural+Yellow	2.25	10.27x8.1	12.55	14.95	14.90	8.40	0.088	0.401x0.316	0.489	0.583	0.581	0.328
C1867	POM	Blue	2.25	9.35	13.25	17.00	15.20	10.00	0.088	0.365	0.517	0.663	0.593	0.390
C3373	POM	Green	2.25	7.65x9.3	13.20	17.05	14.00	8.00	0.088	0.298x0.363	0.515	0.665	0.546	0.312
C3543	POM	Orange	2.25	10.6x8.0	15.10	16.20	15.55	9.85	0.088	0.413x0.312	0.589	0.632	0.606	0.384
C3910	POM	Yellow	2.25	9.4x5.9	13.05x9.1	14.3x9.1	15.20	8.35	0.088	0.367x0.230	0.509x0.355	0.558x0.355	0.593	0.326
C1109	POM	Red/ Light blue	2.30	10.3x7.65	14.70	17.85	17.20	10.50	0.090	0.402x0.298	0.573	0.696	0.671	0.410
C1115	POM	White	2.30	8.25x10.4	13.00	20.10	19.55	13.60	0.090	0.321x0.406	0.507	0.784	0.762	0.530
C1200	POM	Green	2.30	10.6x8.1	10.1x5.0	18.00	18.00	12.90	0.090	0.413x0.316	0.394x0.195	0.702	0.702	0.503
C1236	POM	White/ Black	2.30	8.20	13.00	20.10	19.50	13.60	0.090	0.320	0.507	0.784	0.761	0.530
C1276	PA	Natural	2.30	9.5x7.8	12.40	14.90	18.55	11.80	0.090	0.371x0.304	0.484	0.581	0.723	0.460
C1299	POM	Blue	2.30	8.95x2.5	12.7x8.4	18.20	19.55	13.20	0.090	0.349x0.098	0.495x0.328	0.710	0.762	0.515
C1667	POM	White	2.30	9.85	13.35	16.50	21.60	16.30	0.090	0.384	0.521	0.644	0.842	0.636
C1740	POM	White/ Grey	2.30	11.0x8.05	14.00	17.10	16.20	10.70	0.090	0.429x0.314	0.546	0.667	0.632	0.417
C1796	POM	White	2.30	10.96x8.05	12.80	18.05	18.50	12.05	0.090	0.427x0.314	0.499	0.704	0.722	0.470
C1893	POM	Yellow	2.30	12.4x7.75	12.35	18.15	19.20	12.20	0.090	0.484x0.302	0.482	0.708	0.749	0.476
C1895	POM	Natural	2.30	7.75x7.5	9.80	15.10	16.00	10.30	0.090	0.302x0.293	0.382	0.589	0.624	0.402
C1896	POM	Light yellow	2.30	7.5x7.15	8.0x7.8	15.10	16.10	10.20	0.090	0.293x0.279	0.312x0.304	0.589	0.628	0.398
C1953	PA	Grey	2.30	9.65	13.50	20.50	19.70	12.80	0.090	0.376	0.527	0.800	0.768	0.499
C3265	POM	Brown	2.30	9.30	14.40	18.00	17.15	10.70	0.090	0.363	0.562	0.702	0.669	0.417
C3527	POM	Yellow	2.30	8.2x6.7	7.85x7.75	15.40	15.50	10.40	0.090	0.320x0.261	0.306x0.302	0.601	0.605	0.406
C3717	POM	Orange	2.30	9.0x8.6	13.00	18.10	19.80	13.50	0.090	0.351x0.335	0.507	0.706	0.772	0.527
C3896	POM	Grey	2.30	10.5x7.8	12.50	18.00	16.85	8.90	0.090	0.410x0.304	0.488	0.702	0.657	0.347
C1403	POM	Black	2.35	9.70	15.2x10.1	18.00	17.70	11.60	0.092	0.378	0.593x0.394	0.702	0.690	0.452
C1741	POM	Black	2.35	10.15x8.0	13.25	14.80	14.20	7.50	0.092	0.396x0.312	0.517	0.577	0.554	0.293
C3558	POM	Black	2.35	9.20	13.70	16.90	16.65	9.10	0.092	0.359	0.534	0.659	0.649	0.355
C0278	POM	White	2.40	10.00	13.25	18.10	19.85	14.10	0.094	0.390	0.517	0.706	0.774	0.550
C0842	POM	White	2.40	9.50	13.00	18.00	16.50	11.00	0.094	0.371	0.507	0.702	0.644	0.429
C0981	PA	Black	2.40	11.2x7.6	9.80	17.10	19.10	14.00	0.094	0.437x0.296	0.382	0.667	0.745	0.546
C1360	POM	Blue	2.40	9.35	13.00	16.50	19.00	12.20	0.094	0.365	0.507	0.644	0.741	0.476
C1481	POM	White/ Yellow	2.40	9.50	14.50	17.90	20.70	13.60	0.094	0.371	0.566	0.698	0.807	0.530
C1686	POM	White	2.40	10.2x7.7	13.00	13.00	16.10	11.00	0.094	0.398x0.300	0.507	0.507	0.628	0.429
C1773	POM	Red	2.40	9.40	14.30	17.95	19.00	12.55	0.094	0.367	0.558	0.700	0.741	0.489
C1808	POM	White	2.40	7.2x5.6	9.90	12.25	15.90	10.20	0.094	0.281x0.218	0.386	0.478	0.620	0.398
C1980	POM	Green	2.40	11.75x9.75	17.0x13.0	18.15	17.50	11.35	0.094	0.458x0.380	0.663x0.507	0.708	0.683	0.443
C3009	POM	White	2.40	11.85x7.85	13.15	23.00	21.45	9.80	0.094	0.462x0.306	0.513	0.897	0.837	0.382
C3209	POM	Grey	2.40	9.6x7.6	13.00	15.00	17.10	10.60	0.094	0.374x0.296	0.507	0.585	0.667	0.413
C3303	POM	Natural	2.40	8.6x8.1	13.00	18.00	20.05	12.25	0.094	0.335x0.316	0.507	0.702	0.782	0.478
C3376	POM	Purple	2.40	7.75x9.45	13.25	13.40	20.00	13.75	0.094	0.302x0.369	0.517	0.523	0.780	0.536
C0845	POM	White	2.45	9.2x6.1	12.70	16.55	18.05	12.65	0.096	0.359x0.238	0.495	0.645	0.704	0.493
C1251	POM	Black	2.45	10.2x7.45	15.7x7.0	17.95	17.15	11.00	0.096	0.398x0.291	0.612x0.273	0.700	0.669	0.429
C1283	POM	Natural	2.45	10.50	12.60	18.10	18.30	12.30	0.096	0.410	0.491	0.706	0.714	0.480
C0521	PA	White	2.50	9.0x5.2	11.50	15.00	16.65	9.35	0.098	0.351x0.203	0.449	0.585	0.649	0.365

## DOOR TRIM PANEL CLIP

Part No.	Material	Color	mm						in					
			A	B	C	D	E	F	A	B	C	D	E	F
C0864	PA	White	2.50	9.10	13.00	15.50	17.25	10.30	0.098	0.355	0.507	0.605	0.673	0.402
C0977	POM	Green	2.50	8.10	14.80	17.70	23.00	15.40	0.098	0.316	0.577	0.690	0.897	0.601
C1023	POM	White	2.50	12.2x9.75	14.00	18.50	18.45	12.75	0.098	0.476x0.380	0.546	0.722	0.720	0.497
C1287	PA	Grey	2.50	10.0x8.0	13.65	15.00	20.05	15.05	0.098	0.390x0.312	0.532	0.585	0.782	0.587
C1537	POM	White/ Grey	2.50	9.50	14.40	17.80	20.80	13.45	0.098	0.371	0.562	0.694	0.811	0.525
C1647	POM	Blue	2.50	10.10	14.35	18.00	23.00	15.90	0.098	0.394	0.560	0.702	0.897	0.620
C1655	POM	White + Green	2.50	10.7x8.15	12.55	18.00	18.35	11.80	0.098	0.417x0.318	0.489	0.702	0.716	0.460
C1749	POM	White	2.50	11.0x8.25	14.40	16.20	20.90	14.80	0.098	0.429x0.322	0.562	0.632	0.815	0.577
C1912	POM	White	2.50	12.25x7.85	13.10	15.45	16.55	11.30	0.098	0.478x0.306	0.511	0.603	0.645	0.441
C3225	POM	White	2.50	8.40	14.00	18.50	16.40	9.20	0.098	0.328	0.546	0.722	0.640	0.359
C3325	PA	Black	2.50	9.30	13.20	16.00	18.20	12.30	0.098	0.363	0.515	0.624	0.710	0.480
C3329	POM	Natural	2.50	8.70	13.10	18.00	16.05	10.90	0.098	0.339	0.511	0.702	0.626	0.425
C3377	POM	Pink	2.50	9.4x7.75	13.25	17.10	19.10	12.80	0.098	0.367x0.302	0.517	0.667	0.745	0.499
C3507	POM	Yellow	2.50	8.8x8.3	13.05	18.20	23.65	18.15	0.098	0.343x0.324	0.509	0.710	0.922	0.708
C1265	POM	Black	2.55	8.9x6.5	14.8x6.8	16.00	16.30	10.70	0.099	0.347x0.254	0.577x0.261	0.624	0.636	0.417
C1705	POM	White	2.55	9.15	13.20	18.00	20.00	12.60	0.099	0.357	0.515	0.702	0.780	0.491
C1919	POM	Grey	2.55	8.95x6.7	13.00	17.00	20.20	13.20	0.099	0.349x0.261	0.507	0.663	0.788	0.515
C3063	POM	Green	2.55	11.0x8.0	13.05	17.90	16.00	9.80	0.099	0.429x0.312	0.509	0.698	0.624	0.382
C3221	POM	Yellow	2.55	10.1x7.8	12.70	17.90	20.00	12.80	0.099	0.394x0.304	0.495	0.698	0.780	0.499
C3304	POM	Blue	2.55	9.2x7.7	12.85	18.00	15.80	9.00	0.099	0.359x0.300	0.501	0.702	0.616	0.351
C3555	POM	Natural	2.55	9.45x7.65	17.00	17.90	22.00	15.25	0.099	0.369x0.298	0.663	0.698	0.858	0.595
C3815	POM	Natural	2.55	7.30	10.00	12.10	16.90	11.35	0.099	0.285	0.390	0.472	0.659	0.443
C3836	POM	Red	2.55	11.2x8.0	13.00	17.80	16.60	9.90	0.099	0.437x0.312	0.507	0.694	0.647	0.386
C0255	POM	White	2.60	8.8x8.95	12.80	16.00	16.90	9.80	0.101	0.343x0.349	0.499	0.624	0.659	0.382
C0256	POM	Blue	2.60	9.5x8.8	13.00	15.90	17.50	10.60	0.101	0.371x0.343	0.507	0.620	0.683	0.413
C0583	POM	Yellow	2.60	8.10	15.70	17.80	31.55	24.25	0.101	0.316	0.612	0.694	1.230	0.946
C0658	POM	White	2.60	8.4x6.7	14.70	18.00	21.75	13.50	0.101	0.328x0.261	0.573	0.702	0.848	0.527
C1220	POM	Green	2.60	9.30	13.80	18.50	18.15	12.45	0.101	0.363	0.538	0.722	0.708	0.486
C1220DY	POM	Green	2.60	9.30	13.80	18.50	18.15	12.45	0.101	0.363	0.538	0.722	0.708	0.486
C1401	POM	White	2.60	8.65x8.2	12.80	17.75	20.00	13.70	0.101	0.337x0.320	0.499	0.692	0.780	0.534
C1701	POM	Grey	2.60	12.1x9.7	14.00	18.65	19.20	12.70	0.101	0.472x0.378	0.546	0.727	0.749	0.495
C1859	POM	White	2.60	10.4x8.0	14.50	16.80	17.35	11.75	0.101	0.406x0.312	0.566	0.655	0.677	0.458
C3291	POM	Natural/Grey	2.60	9.45	12.55	18.10	18.00	10.90	0.101	0.369	0.489	0.706	0.702	0.425
C3294	POM	White/Light blue	2.60	9.20	13.30	18.10	17.00	11.10	0.101	0.359	0.519	0.706	0.663	0.433
C3405	POM	Grey	2.60	9.0x7.0	12.80	17.00	20.00	13.10	0.101	0.351x0.273	0.499	0.663	0.780	0.511
C0960	POM	Blue	2.65	9.50	13.20	18.00	19.85	13.60	0.103	0.371	0.515	0.702	0.774	0.530
C1187	POM	White	2.65	10.0x7.6	13.00	16.25	22.30	14.40	0.103	0.390x0.296	0.507	0.634	0.870	0.562
C1412	POM	White	2.65	9.3x7.6	13.00	20.40	18.40	11.75	0.103	0.363x0.296	0.507	0.796	0.718	0.458
C1767	POM	Blue	2.65	9.1x7.25	12.90	17.00	20.00	13.10	0.103	0.355x0.283	0.503	0.663	0.780	0.511
C1818	POM	White	2.65	9.05	13.75	17.00	15.90	10.00	0.103	0.353	0.536	0.663	0.620	0.390
C1935	POM	White	2.65	8.9x8.3	12.90	18.00	16.40	9.90	0.103	0.347x0.324	0.503	0.702	0.640	0.386
C1963	POM	White	2.65	10.0x6.85	12.95	15.10	20.30	13.00	0.103	0.390x0.267	0.505	0.589	0.792	0.507
C3700	POM	Grey	2.65	10.3x7.95	12.50	18.20	17.65	10.40	0.103	0.401x0.310	0.488	0.710	0.688	0.406

## DOOR TRIM PANEL CLIP

Part No.	Material	Color	mm						in					
			A	B	C	D	E	F	A	B	C	D	E	F
C3775	POM	Black+Natural	2.65	10.1x8.4	12.95	18.20	16.70	10.25	0.103	0.364x0.328	0.505	0.710	0.651	0.400
C3971	POM	Black	2.65	9.9x7.4	11.60	18.10	18.40	12.60	0.103	0.386x0.289	0.452	0.706	0.718	0.491
C3190	POM	Natural	2.70	5.80	10.95x6.45	13.55	12.75	7.85	0.105	0.226	0.427x0.252	0.528	0.497	0.306
C3236	POM	Red	2.70	7.55	12.75	18.05	16.80	10.30	0.105	0.294	0.497	0.704	0.655	0.402
C3494	POM	Yellow	2.70	8.40	13.00	17.90	21.55	14.15	0.105	0.328	0.507	0.698	0.840	0.552
C3535	POM	Natural	2.70	8.40	15.90	17.90	21.45	14.05	0.105	0.328	0.620	0.698	0.837	0.548
C1499	POM	Black	2.70	8.75x8.45	12.90	18.00	15.55	10.00	0.105	0.341x0.330	0.503	0.702	0.606	0.390
C3513	POM	White	2.70	8.8x8.55	12.95	17.90	19.90	13.25	0.105	0.343x0.333	0.505	0.698	0.776	0.517
C1186	POM	Blue	2.70	9.0x8.8	13.00	17.90	17.30	9.95	0.105	0.351x0.343	0.507	0.698	0.675	0.388
C0534	POM	White	2.70	9.40	12.80	15.60	20.60	13.70	0.105	0.367	0.499	0.608	0.803	0.534
C0625	POM	Grey	2.70	9.45	13.00	15.30	18.50	11.10	0.105	0.369	0.507	0.597	0.722	0.433
C1699	POM	Natural	2.70	9.45	13.35	18.00	18.00	12.00	0.105	0.369	0.521	0.702	0.702	0.468
C3174	POM	Green	2.70	9.45	12.90	18.10	17.30	11.00	0.105	0.369	0.503	0.706	0.675	0.429
C1661	POM	White	2.70	9.45x7.8	12.95	17.35	18.55	12.30	0.105	0.369x0.304	0.505	0.677	0.723	0.480
C3838	POM	Red	2.70	9.7x8.1	13.00	18.00	21.10	14.60	0.105	0.378x0.316	0.507	0.702	0.823	0.569
C3524	POM	Natural	2.70	9.50	13.25	16.10	17.00	9.75	0.105	0.371	0.517	0.628	0.663	0.380
C3865	POM	Black	2.70	9.90	13.00	18.00	15.75	9.45	0.105	0.386	0.507	0.702	0.614	0.369
C0391	POM	Natural/White /Yellow/Green	2.70	9.95	13.20	18.30	20.30	13.65	0.105	0.388	0.515	0.714	0.792	0.532
C3361	POM	Yellow	2.70	10.0x6.45	14.90	18.00	23.10	14.90	0.105	0.390x0.252	0.581	0.702	0.901	0.581
C1899	POM	Natural	2.70	11.0x8.15	13.00	18.00	19.95	13.50	0.105	0.429x0.318	0.507	0.702	0.778	0.527
C0396	POM	White	2.70	11.2x7.8	19.45	19.45	25.90	15.90	0.105	0.437x0.304	0.759	0.759	1.010	0.620
C0639	POM	White	2.70	11.4x9.2	14.85	20.00	20.65	16.00	0.105	0.445x0.359	0.579	0.780	0.805	0.624
C0989	POM	Black	2.70	12.35x5.9	13.15	18.00	19.55	13.00	0.105	0.483x0.230	0.513	0.702	0.762	0.507
C0371	POM	Red	2.75	9.60	12.85	15.75	20.70	13.70	0.107	0.374	0.501	0.614	0.807	0.534
C1195	POM	White	2.75	9.7x8.05	12.50	15.50	14.30	7.75	0.107	0.378x0.314	0.488	0.605	0.558	0.302
C1599	POM	White/ Light blue	2.75	9.4x8.7	12.95	18.00	18.70	13.00	0.107	0.367x0.339	0.505	0.702	0.729	0.507
C1982	POM	Grey	2.75	11.00	14.00	18.50	19.75	13.45	0.107	0.429	0.546	0.722	0.770	0.525
C3382	POM	Green	2.75	7.1x9.3	15.00	17.00	20.00	13.80	0.107	0.277x0.363	0.585	0.663	0.780	0.538
C3677	POM	Black	2.75	8.85	11.60	18.00	18.80	12.90	0.107	0.345	0.452	0.702	0.733	0.503
C3822	POM	Natural	2.75	11.6x7.45	14.80	19.36	22.90	15.60	0.107	0.452x0.290	0.577	0.755	0.893	0.608
C0939	POM	Green	2.80	9.10	12.90	18.70	18.00	12.00	0.109	0.355	0.503	0.729	0.702	0.468
C1127	POM	White	2.80	8.90	15.4x7.1	16.70	17.00	11.00	0.109	0.347	0.601x0.277	0.651	0.663	0.429
C1500	PA	Blue	2.80	8.05x6.0	13.85x9.85	15.85	18.00	13.30	0.109	0.314x0.234	0.540x0.384	0.618	0.702	0.519
C1834	POM	Natural	2.80	8.65x5.8	17.0x12.1	17.90	16.10	8.35	0.109	0.337x0.226	0.663x0.472	0.698	0.628	0.326
C3638	PA	Black	2.80	8.0x10.7	13.30	18.70	25.00	16.65	0.109	0.312x0.417	0.519	0.729	0.975	0.649
C3806	POM	Natural	2.80	16.1x14.55	13.00	27.00	21.80	16.60	0.109	0.628x0.567	0.507	1.053	0.850	0.647
C3886	POM	Natural	2.80	8.9x6.6	15.95	15.95	19.90	12.60	0.109	0.347x0.257	0.622	0.622	0.776	0.491
C1858	POM	Yellow	2.85	9.0x6.8	15.15	17.20	20.00	13.60	0.111	0.351x0.265	0.591	0.671	0.780	0.530
C1930	POM	Black	2.85	8.40	13.05	18.00	22.20	14.20	0.111	0.328	0.509	0.702	0.866	0.554
C4001	PA	Natural	2.85	9.3x7.3	13.25	18.00	19.55		0.111	0.363x0.285	0.517	0.702	0.762	0.000
C0257	POM	White	2.90	8.55x8.65	13.25	18.05	13.95	8.05	0.113	0.333x0.337	0.517	0.704	0.544	0.314
C0275	POM	White	2.90	7.75	13.15	16.90	18.65	13.70	0.113	0.302	0.513	0.659	0.727	0.534
C1129	POM	Black/ Grey	2.90	8.9x7.7	13.10	18.00	20.35	13.80	0.113	0.347x0.300	0.511	0.702	0.794	0.538
C1527	POM	Natural	2.90	8.6x8.0	10.90	17.00	20.40	14.10	0.113	0.335x0.312	0.425	0.663	0.796	0.550

## DOOR TRIM PANEL CLIP

Part No.	Material	Color	mm						in					
			A	B	C	D	E	F	A	B	C	D	E	F
C1688	POM	Natural	2.90	5.75	9.65	13.65	13.10	7.30	0.113	0.224	0.376	0.532	0.511	0.285
C1821	POM	White	2.90	10.9x8.1	13.00	18.10	20.05	14.45	0.113	0.425x0.316	0.507	0.706	0.782	0.564
C3088	POM+PA	Yellow+Black	2.90	8.00	15.80	17.50	15.90	11.40	0.113	0.312	0.616	0.683	0.620	0.445
C3222	POM	White	2.90	9.35x7.75	12.85	18.00	22.55	15.30	0.113	0.365x0.302	0.501	0.702	0.879	0.597
C3259	POM	Natural	2.90	10.05	10.10	18.30	17.90	11.00	0.113	0.392	0.394	0.714	0.698	0.429
C3286	POM	Natural	2.90	9.95	13.00	18.00	19.70	12.20	0.113	0.388	0.507	0.702	0.768	0.476
C3491	POM	Natural	2.90	12.3x7.7	13.00	16.00	18.85	13.60	0.113	0.480x0.300	0.507	0.624	0.735	0.530
C0199	PA	White	2.95	8.6x4.6	13.10	19.00	24.10	15.60	0.115	0.335x0.179	0.511	0.741	0.940	0.608
C0841	PA	Black/ White/ Beige	2.95	9.40	13.60	18.10	21.10	14.00	0.115	0.367	0.530	0.706	0.823	0.546
C0843	PA	Black	2.95	11.00	10.20	18.00	19.85	13.00	0.115	0.429	0.398	0.702	0.774	0.507
C1101	POM	Black	2.95	6.36x4.9	12.00	11.80	15.70	9.50	0.115	0.248x0.191	0.468	0.460	0.612	0.371
C1998	POM	Light grey	2.95	10.35x7.7	13.10	16.40	18.50	10.70	0.115	0.404x0.300	0.511	0.640	0.722	0.417
C3270	POM	Green	2.95	8.60	13.00	18.10	21.10	12.50	0.115	0.335	0.507	0.706	0.823	0.488
C0067	PA	White	3.00	9.50	13.20	16.50	17.90	11.00	0.117	0.371	0.515	0.644	0.698	0.429
C0244	POM	Natural	3.00	9.8x8.3	12.85	18.10	19.75	14.70	0.117	0.382x0.324	0.501	0.706	0.770	0.573
C0271	POM	White	3.00	11.3x7.65	12.95	18.00	18.70	11.05	0.117	0.441x0.298	0.505	0.702	0.729	0.431
C0392	PA	White + Blue	3.00	9.35	13.30	18.20	19.70	13.70	0.117	0.365	0.519	0.710	0.768	0.534
C0670	PA	White+Yellow	3.00	9.3x7.8	10.95	17.95	28.80	18.70	0.117	0.363x0.304	0.427	0.700	1.123	0.729
C1022	POM	Fuchsia+White	3.00	10.40	13.00	16.00	24.00	17.20	0.117	0.406	0.507	0.624	0.936	0.671
C1298	POM	Natural	3.00	11.8x7.65	12.00	12.00	15.80	10.80	0.117	0.460x0.298	0.468	0.468	0.616	0.421
C1344	POM	Blue	3.00	8.95x9.8	13.4x14.4	18.20	20.90	13.40	0.117	0.349x0.382	0.523x0.562	0.710	0.815	0.523
C1458	POM	Yellow	3.00	9.50	12.85	18.20	19.10	12.10	0.117	0.371	0.501	0.710	0.745	0.472
C1552	POM	Natural	3.00	12.2x8.0	13.00	18.00	18.20	10.85	0.117	0.476x0.312	0.507	0.702	0.710	0.423
C1557	PA	Yellow	3.00	10.5x7.6	13.00	17.50	21.00	15.00	0.117	0.410x0.296	0.507	0.683	0.819	0.585
C1700	POM	White	3.00	9.00	12.80	18.00	20.10	13.20	0.117	0.351	0.499	0.702	0.784	0.515
C1763	POM	White	3.00	13.5x7.54	13.00	18.40	18.85	14.25	0.117	0.527x0.294	0.507	0.718	0.735	0.556
C1910	POM	Blue	3.00	8.45x9.05	13.00	18.00	13.90	8.20	0.117	0.330x0.353	0.507	0.702	0.542	0.320
C3807	POM	Natural	3.00	9.80	13.00	16.00	20.60	15.00	0.117	0.382	0.507	0.624	0.803	0.585
C3891	POM	White	3.00	9.30	15.00	18.00	18.15	11.70	0.117	0.363	0.585	0.702	0.708	0.456
C0270	POM	Grey	3.05	9.60	13.00	18.00	20.90	13.75	0.119	0.374	0.507	0.702	0.815	0.536
C1830	POM	Black	3.05	9.85x7.8	13.10	17.65	21.45	15.30	0.119	0.384x0.304	0.511	0.688	0.837	0.597
C3311	POM	White	3.05	9.5x7.8	9.85x11.9	18.20	16.05	10.25	0.119	0.371x0.304	0.384x0.464	0.710	0.626	0.400
C3898	POM	Blue	3.05	12.4x7.70	12.90	18.00	18.55	11.00	0.119	0.484x0.300	0.503	0.702	0.723	0.429
C0624	POM	Yellow	3.10	9.95	13.00	18.30	23.90	16.60	0.121	0.388	0.507	0.714	0.932	0.647
C1819	POM	Black	3.10	10.25	14.30	15.40	20.50	15.40	0.121	0.400	0.558	0.601	0.800	0.601
C1844	POM	Natural	3.10	9.20	13.70	18.40	22.85	16.35	0.121	0.359	0.534	0.718	0.891	0.638
C1277	POM	Blue	3.15	8.85	15.15	18.50	19.95	13.40	0.123	0.345	0.591	0.722	0.778	0.523
C3314	POM	Natural	3.15	9.6x7.5	9.8x11.9	18.00	17.30	11.25	0.123	0.374x0.293	0.382x0.464	0.702	0.675	0.439
C1539	POM	White	3.20	9.60	11.95	17.90	21.15	16.10	0.125	0.374	0.466	0.698	0.825	0.628
C0994	POM	Natural	3.25	9.15x5.5	13.15	16.80	16.25	10.40	0.127	0.357x0.215	0.513	0.655	0.634	0.406
C1976	POM	White	3.30	10.8x9.7	14.95	18.50	19.80	13.10	0.129	0.421x0.378	0.583	0.722	0.772	0.511
C3537	POM	Natural	3.30	10.10	12.80	18.00	21.80	14.30	0.129	0.394	0.499	0.702	0.850	0.558
C3983	POM	Natural	3.30	10.85x7.3	13.15x16.0	17.90	19.40	13.15	0.129	0.423x0.284	0.513x0.624	0.698	0.757	0.513
C1295	POM	Natural	3.40	9.20	15.80	19.50	17.80	11.00	0.133	0.359	0.616	0.761	0.694	0.429

## DOOR TRIM PANEL CLIP

Part No.	Material	Color	mm						in					
			A	B	C	D	E	F	A	B	C	D	E	F
C1579	POM	White	3.40	12.2x7.9	8.1x7.6	21.20	17.50	8.70	0.133	0.476x0.308	0.527x0.195	0.827	0.683	0.339
C3340	POM	Grey	3.70	10.0x7.5	16.55	16.60	23.50	14.60	0.144	0.390x0.293	0.645	0.647	0.917	0.569
C0056	PA	White	3.80	9.60	12.90	17.80	21.70	13.90	0.148	0.374	0.503	0.694	0.846	0.542
C1641	POM	Yellow	3.90	12.4x7.8	13.00	18.00	20.10	10.30	0.152	0.484x0.304	0.507	0.702	0.784	0.402
C3693	POM	Black	4.10	12.9x7.8	12.95	15.95	22.25	12.35	0.160	0.503x0.304	0.505	0.622	0.868	0.482
C3427	POM	Natural	4.30	11.50	19.10	19.10	27.60	15.80	0.168	0.449	0.745	0.745	1.076	0.616

**Product No.: C0617**

**Material:** POM  
**Color:** Yellow  
**Position:** Door panel



Product Details

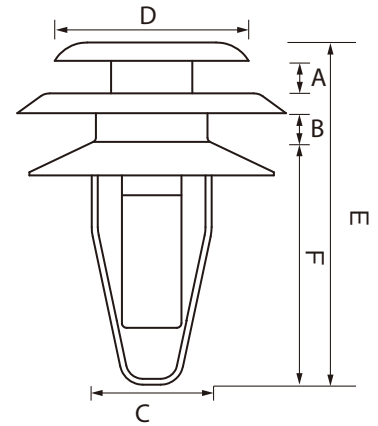

Part No.	Material	Color	mm						in					
			A	B	C	D	E	F	A	B	C	D	E	F
C1591	PA	Brown	2.00	2.60	10.9x8.7	11.6x15.0	29.90	16.10	0.078	0.101	0.425x0.339	0.452x0.585	1.166	0.628
C0064	PA	White	2.15	1.80	7.85x10.75	12.70	22.60	13.85	0.084	0.070	0.306x0.419	0.495	0.881	0.540
C0347	POM	White+Yellow	2.20	1.70	10.6x7.8	13.20	24.70	13.15	0.086	0.066	0.413x0.304	0.515	0.963	0.513
C0355	POM	White	2.20	5.25	10.6x8.9	15.00	32.20	16.15	0.086	0.205	0.413x0.347	0.585	1.256	0.630
C0225	POM	White	2.35	4.00	11.0x9.15	14.80	31.80	16.50	0.092	0.156	0.429x0.357	0.577	1.240	0.644
C3571	PA	Yellow	2.45	1.55	9.55x6.5	12.55	20.75	13.05	0.096	0.060	0.372x0.254	0.489	0.809	0.509
C0617	POM	Yellow	2.60	2.55	9.20	12.90	28.20	17.70	0.101	0.099	0.359	0.503	1.100	0.690
C1770	POM	White	2.60	3.10	11.85x8.25	15.80	28.25	16.45	0.101	0.121	0.462x0.322	0.616	1.102	0.642
C3824	POM	Natural + Black	2.80	2.30	10.20	17.85	22.25	11.45	0.109	0.090	0.398	0.696	0.868	0.447
C1909	POM	White	2.85	3.50	12.3x9.0	15.90	30.10	18.15	0.111	0.137	0.480x0.351	0.620	1.174	0.708
C1378	POM	Blue	2.90	1.30	8.65x5.05	13.00	19.70	11.00	0.113	0.051	0.337x0.197	0.507	0.768	0.429
C1946	POM	Yellow	2.90	5.50	10.9x8.7	15.85	30.00	13.45	0.113	0.215	0.425x0.339	0.618	1.170	0.525
C0385	POM	White+Yellow	3.00	3.45	8.50	11.85	20.00	5.00	0.117	0.135	0.332	0.462	0.780	0.195
C3561	POM	Natrual+Black	3.00	5.20	11.0x8.7	15.80	30.15	15.20	0.117	0.203	0.429x0.339	0.616	1.176	0.593
C0599	POM	White	3.10	8.10	8.25x6.75	14.90	36.05	16.90	0.121	0.316	0.322x0.263	0.581	1.406	0.659
C1459	POM	Yellow	3.10	3.80	8.8x5.0	13.40	22.60	11.00	0.121	0.148	0.343x0.195	0.523	0.881	0.429
C3590	POM	Natural+Black	4.80	8.40	8.40	13.85	37.20	14.00	0.187	0.328	0.328	0.540	1.451	0.546

## DOOR TRIM PANEL CLIP

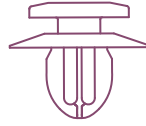

C0056

**Material:** PA  
**Color:** White  
**Door panel**

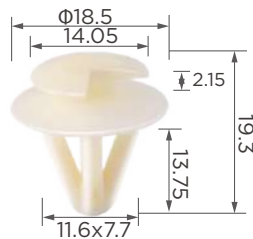

C0061

**Material:** PA  
**Color:** White  
**Door panel**



C0067

**Material:** PA  
**Color:** White  
**Door panel, floor**

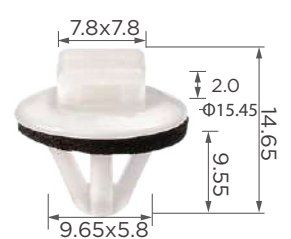

C0166

**Material:** PA  
**Color:** White  
**Door panel moulding, rear moulding**



C0199

**Material:** PA  
**Color:** White  
**Door panel**



C0244

**Material:** POM  
**Color:** Natural  
**Door panel, tailgate**



C0255

**Material:** POM  
**Color:** White  
**Interior, door moulding**

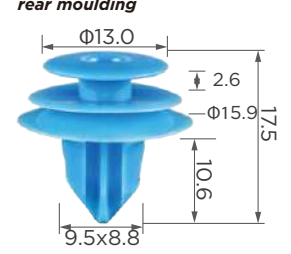

C0256

**Material:** POM  
**Color:** Blue  
**Door panel, roof**



C0257

**Material:** POM  
**Color:** White  
**Door panel, rocker panel**

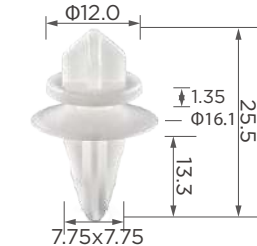

C0258

**Material:** POM  
**Color:** White  
**Door panel**



C0270

**Material:** POM  
**Color:** Grey  
**Door panel**



C0271

**Material:** POM  
**Color:** White  
**Door panel, grille, gasket**



C0275

**Material:** POM  
**Color:** White  
**Side panel, rear panel**



C0278

**Material:** POM  
**Color:** White  
**Rocker panel**

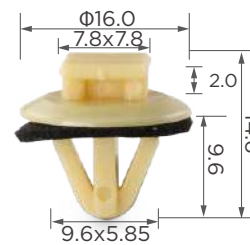

C0356

**Material:** POM  
**Color:** Yellow  
**Rear panel trim strip**



C0369

**Material:** POM  
**Color:** White  
**Interior**



# DOOR TRIM PANEL CLIP



C0371

**Material:** POM  
**Color:** Red  
**Door panel, hood**



C0382

**Material:** POM  
**Color:** White  
**Door panel, fender**



C0391

**Material:** POM  
**Color:** Natural/ White/ Yellow/ Green  
**Door panel, inner trunk lid**



C0392

**Material:** PA  
**Color:** White + Blue  
**Door panel**



C0396

**Material:** POM  
**Color:** White  
**Door panel**



C0521

**Material:** PA  
**Color:** White  
**Door panel**



C0534

**Material:** POM  
**Color:** White  
**Door panel**



C0583

**Material:** POM  
**Color:** Yellow  
**Door panel**

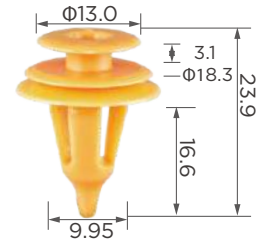

C0624

**Material:** POM  
**Color:** Yellow  
**Door panel**



C0625

**Material:** POM  
**Color:** Grey  
**Door panel, floor**



C0639

**Material:** POM  
**Color:** White  
**Door panel**



C0658

**Material:** POM  
**Color:** White  
**Door panel**



C0670

**Material:** PA  
**Color:** White+Yellow  
**Door panel**

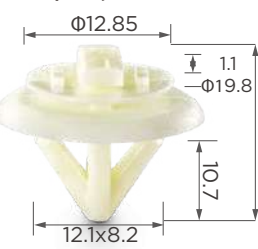

C0691

**Material:** PA  
**Color:** White  
**Retainer**

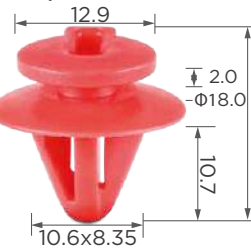

C0813

**Material:** POM  
**Color:** Red  
**Lower Center Pillar Trim**



C0819

**Material:** POM  
**Color:** White  
**Door moulding**



C0841

**Material:** PA  
**Color:** Black/ White/ Beige  
**Inner trunk lid**



C0842

**Material:** POM  
**Color:** White  
**Door panel**



C0843

**Material:** PA  
**Color:** Black  
**Door panel**



C0845

**Material:** POM  
**Color:** White  
**Interior, floor**

## DOOR TRIM PANEL CLIP



C0864

**Material:** PA  
**Color:** White  
**Door panel**

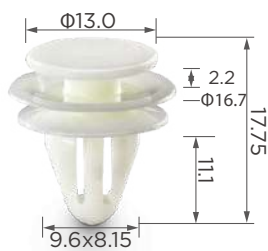

C0876

**Material:** POM  
**Color:** White  
**Wheelarch fender**



C0935

**Material:** POM  
**Color:** White  
**Fender**

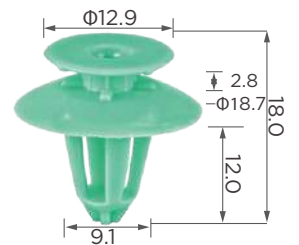

C0939

**Material:** POM  
**Color:** Green  
**Door panel**



C0943

**Material:** PA  
**Color:** White  
**Bumper**

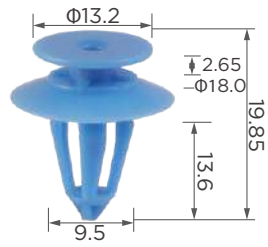

C0960

**Material:** POM  
**Color:** Blue  
**Door panel**

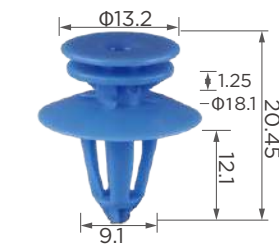

C0961

**Material:** POM  
**Color:** Blue  
**Door panel**



C0977

**Material:** POM  
**Color:** Green  
**Door panel**

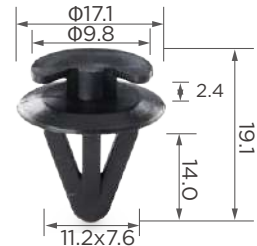

C0981

**Material:** PA  
**Color:** Black  
**Door panel**



C0989

**Material:** POM  
**Color:** Black  
**Door panel**



C0992

**Material:** POM  
**Color:** Black  
**Door panel**



C0994

**Material:** POM  
**Color:** Natural  
**Door panel**



C1022

**Material:** POM  
**Color:** Fuchsia+White  
**Door panel**



C1023

**Material:** POM  
**Color:** White  
**Rocker panel**



C1101

**Material:** POM  
**Color:** Black  
**Door panel**

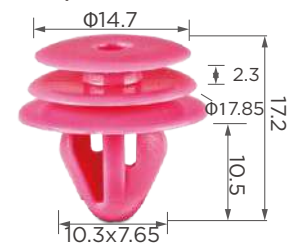

C1109

**Material:** POM  
**Color:** Red/ Light blue  
**Door panel**

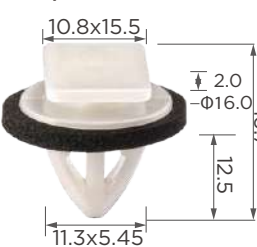

C1114

**Material:** POM  
**Color:** White  
**Side moulding**



C1115

**Material:** POM  
**Color:** White  
**Grille, rear panel, tail light**

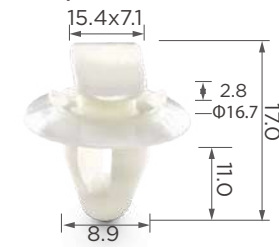

C1127

**Material:** POM  
**Color:** White  
**Door panel**



C1129

**Material:** POM  
**Color:** Black/ Grey  
**Retainer**

# DOOR TRIM PANEL CLIP

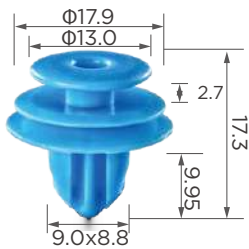

C1186

**Material:** POM  
**Color:** Blue

**Door panel**



C1220

**Material:** POM  
**Color:** Green

**Rear door**

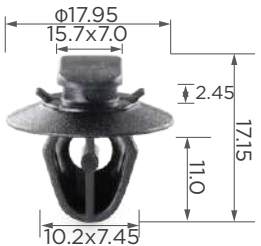

C1251

**Material:** POM  
**Color:** Black

**Door panel**



C1279

**Material:** POM  
**Color:** White

**Door panel**



C1294

**Material:** PA  
**Color:** Black  
**Retainer**



C1187

**Material:** POM  
**Color:** White

**Pillar, rear door**

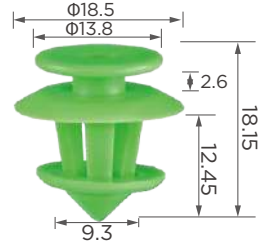

C1220DY

**Material:** POM  
**Color:** Green

**Door panel**



C1265

**Material:** POM  
**Color:** Black

**Door panel**



C1281

**Material:** PA  
**Color:** Black

**Door panel**



C1295

**Material:** POM  
**Color:** Natural  
**Rear door**



C1195

**Material:** POM  
**Color:** White

**Door moulding**



C1226

**Material:** POM  
**Color:** Black

**Door panel, rocker panel**



C1276

**Material:** PA  
**Color:** Natural

**Trunk**



C1283

**Material:** POM  
**Color:** Natural

**Door panel**



C1298

**Material:** POM  
**Color:** Natural  
**Rocker panel**



C1200

**Material:** POM  
**Color:** White

**Rocker panel**



C1236

**Material:** POM  
**Color:** White/ Black

**Rear tray, floor attachment**

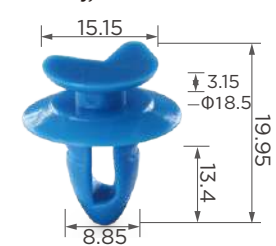

C1277

**Material:** POM  
**Color:** Blue

**Bumper, rocker panel**

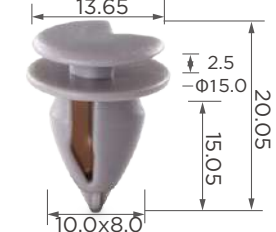

C1287

**Material:** PA  
**Color:** Grey

**Retainer**

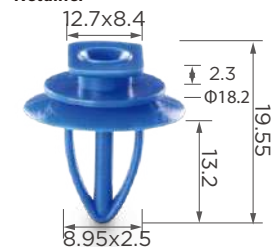

C1299

**Material:** POM  
**Color:** Blue  
**Door panel**

# DOOR TRIM PANEL CLIP



C1321

**Material:** POM  
**Color:** Black  
**Door panel**



C1339

**Material:** POM  
**Color:** White  
**Rocker panel, fender flare**



C1344

**Material:** POM  
**Color:** Blue  
**Side moulding, wheel arch**



C1345

**Material:** POM  
**Color:** Yellow  
**Wheel arch**

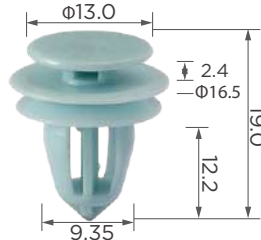

C1360

**Material:** POM  
**Color:** Blue  
**Door garnish**



C1379

**Material:** POM  
**Color:** Blue  
**Fascia**



C1401

**Material:** POM  
**Color:** White/ Red  
**Rocker panel**

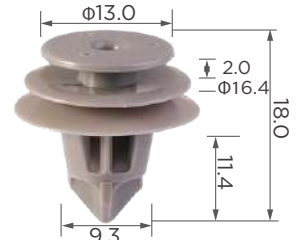

C1402

**Material:** POM  
**Color:** Grey  
**Hood, cowl vent**



C1403

**Material:** POM  
**Color:** Black  
**Rocker panel**

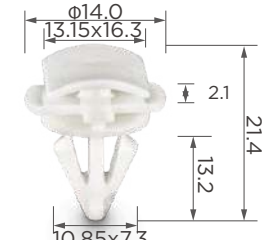

C1410

**Material:** POM  
**Color:** White  
**Side panel moulding**



C1412

**Material:** POM  
**Color:** White  
**Retainer**



C1416A

**Material:** POM  
**Color:** Black  
**Door upholstery interior trim**



C1436

**Material:** POM  
**Color:** Grey  
**Wheel arch**

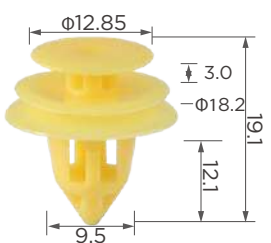

C1458

**Material:** POM  
**Color:** Yellow  
**Edge protector, interior moulding**

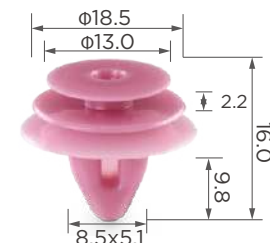

C1460

**Material:** POM  
**Color:** Pink  
**Door panel**



C1461

**Material:** POM  
**Color:** Pink  
**Rocker panel, fender flare**



C1470

**Material:** PA  
**Color:** Natural  
**Rocker panel**



C1478

**Material:** POM  
**Color:** White  
**Rocker panel**



C1481

**Material:** POM  
**Color:** White/ Yellow  
**Interior**



C1497

**Material:** POM  
**Color:** Natural  
**Door panel, fender, wheelarch**



# DOOR TRIM PANEL CLIP



C1499

**Material:** POM  
**Color:** Black

**Door panel**



C1552

**Material:** POM  
**Color:** Natural

**Door panel, headlight**

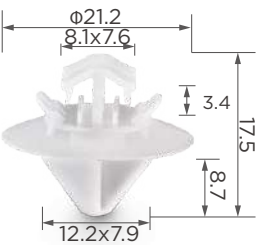

C1579

**Material:** POM  
**Color:** White

**Rear panel**

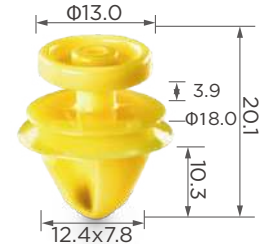

C1641

**Material:** POM  
**Color:** Yellow

**Rocker panel**



C1655

**Material:** POM  
**Color:** White + Green  
**Door panel**

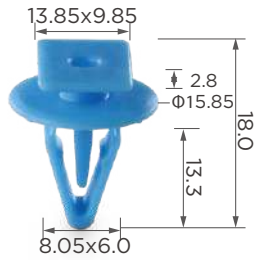

C1500

**Material:** PA  
**Color:** Blue

**Hood**



C1539

**Material:** POM  
**Color:** Natural

**Rocker panel**



C1598

**Material:** POM  
**Color:** White

**Rocker panel, wheelarch**



C1643

**Material:** POM  
**Color:** Black

**Door panel**



C1656

**Material:** POM  
**Color:** White  
**Rocker panel**

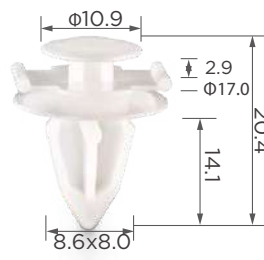

C1527

**Material:** POM  
**Color:** Natural

**Grille**

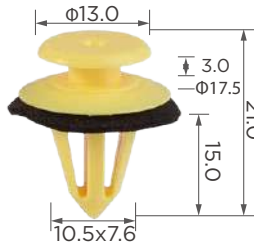

C1557

**Material:** PA  
**Color:** Yellow

**Door panel, windshield moulding**



C1599

**Material:** POM  
**Color:** White/ Light blue

**Rocker panel**

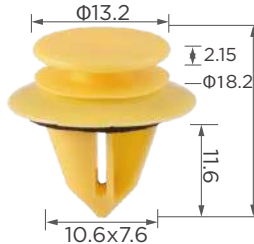

C1645

**Material:** POM  
**Color:** Yellow

**Pillar**



C1661

**Material:** POM  
**Color:** White  
**Pillar**



C1537

**Material:** POM  
**Color:** White/ Grey

**Door panel**



C1576

**Material:** POM  
**Color:** Black

**Door panel**



C1616

**Material:** POM  
**Color:** Yellow

**Roof panel moulding**



C1647

**Material:** POM  
**Color:** Blue

**Bumper, rocker panel**



C1667

**Material:** POM  
**Color:** White  
**Door panel**

# DOOR TRIM PANEL CLIP



C1686

**Material:** POM  
**Color:** White  
**Rocker panel**



C1699

**Material:** POM  
**Color:** Natural  
**Rear panel**



C1705

**Material:** POM  
**Color:** White  
**Rear trunk, pillar, door panel**



C1740

**Material:** POM  
**Color:** White/ Grey  
**Windshield moulding**



C1763

**Material:** POM  
**Color:** White  
**Floor, grille, door panel**



C1688

**Material:** POM  
**Color:** White  
**Door panel**



C1700

**Material:** POM  
**Color:** White  
**Door panel, rear trunk**



C1709

**Material:** POM  
**Color:** White  
**Floor, rear tray**



C1741

**Material:** POM  
**Color:** Black  
**Rocker panel, fender flare**

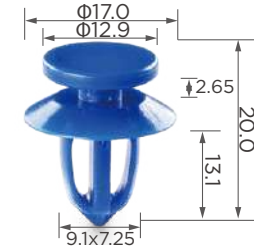

C1767

**Material:** POM  
**Color:** Blue  
**Door panel, rocker panel**



C1691

**Material:** POM  
**Color:** White  
**Door panel**



C1701

**Material:** POM  
**Color:** Grey  
**Rocker panel**



C1717

**Material:** POM  
**Color:** Black  
**Side moulding, rocker panel**



C1749

**Material:** POM  
**Color:** White  
**Door panel, pillar**



C1773

**Material:** POM  
**Color:** Natural/ Red  
**Door panel**



C1695

**Material:** POM  
**Color:** Black  
**Door panel**



C1702

**Material:** POM  
**Color:** White  
**Fender flare, wheelarch**



C1726

**Material:** POM  
**Color:** White  
**Door panel**



C1762

**Material:** POM  
**Color:** Natural  
**Rocker panel**



C1782

**Material:** POM  
**Color:** White  
**Rocker panel**



# DOOR TRIM PANEL CLIP



C1795

**Material:** POM  
**Color:** Yellow  
**Door panel**



C1796

**Material:** POM  
**Color:** White  
**Door panel**



C1808

**Material:** POM  
**Color:** White  
**Door panel, rear mirror**



C1811

**Material:** POM  
**Color:** White  
**Door panel, pillar**



C1818

**Material:** POM  
**Color:** White  
**Door panel, roof**



C1819

**Material:** POM  
**Color:** Black  
**Rear trunk, roof, door panel**



C1821

**Material:** POM  
**Color:** White  
**Door panel**



C1830

**Material:** POM  
**Color:** Black  
**Door panel**

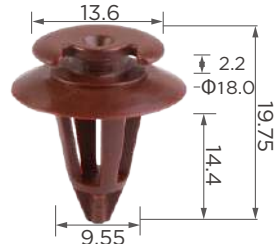

C1831

**Material:** PA  
**Color:** Brown  
**Rear trunk, roof, door panel, braking**



C1833

**Material:** POM  
**Color:** Natural+ Yellow  
**Door panel, rocker panel, rear trunk**



C1834

**Material:** POM  
**Color:** Natural  
**Rocker panel**



C1844

**Material:** POM  
**Color:** Natural  
**Rear door**

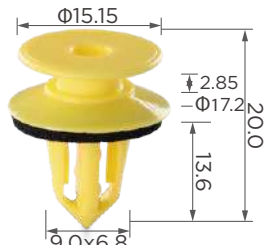

C1858

**Material:** POM  
**Color:** Yellow  
**Door panel, rear trunk**



C1859

**Material:** POM  
**Color:** White  
**Bumper**



C1862

**Material:** POM  
**Color:** Green  
**Door panel, floor, rear trunk, hood, mirror**



C1867

**Material:** POM  
**Color:** Blue  
**Roof**



C1877

**Material:** POM  
**Color:** Black  
**Door panel**



C1893

**Material:** POM  
**Color:** Yellow  
**Door panel, rear trunk**



C1894

**Material:** POM  
**Color:** Yellow  
**Spoiler**



C1895

**Material:** POM  
**Color:** Natural  
**Rocker panel, wheelarch**

# DOOR TRIM PANEL CLIP



C1896

**Material:** POM  
**Color:** Light yellow  
**Side moulding**



C1899

**Material:** POM  
**Color:** Natural  
**Door moulding**

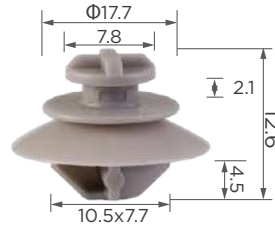

C1907

**Material:** POM  
**Color:** Grey  
**Door panel**

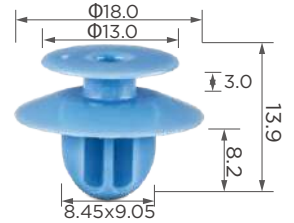

C1910

**Material:** POM  
**Color:** Blue  
**Door panel, rocker panel, side moulding**

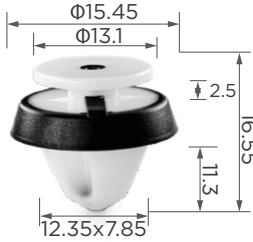

C1912

**Material:** POM  
**Color:** White  
**Door panel, pillar, side moulding**



C1916

**Material:** POM  
**Color:** Natural  
**Rocker panel**

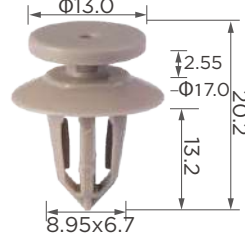

C1919

**Material:** POM  
**Color:** Grey  
**Door panel**



C1930

**Material:** POM  
**Color:** Black  
**Bumper**

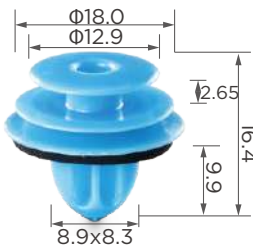

C1935

**Material:** POM  
**Color:** Blue  
**Door panel**



C1949

**Material:** PA  
**Color:** Yellow  
**Central**

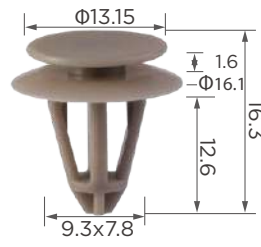

C1950

**Material:** POM  
**Color:** Grey  
**Floor**



C1953

**Material:** PA  
**Color:** Grey  
**Floor**



C1963

**Material:** POM  
**Color:** White  
**Bumper**



C1975

**Material:** POM  
**Color:** White  
**Rocker panel, side moulding**



C1976

**Material:** POM  
**Color:** White  
**Door panel, rocker panel**

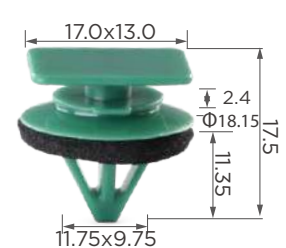

C1980

**Material:** POM  
**Color:** Green  
**Rocker panel**



C1982

**Material:** POM  
**Color:** Grey  
**Rocker panel, wheelarch**

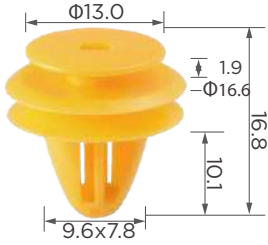

C1995

**Material:** POM  
**Color:** Yellow  
**Door panel, interior, mirror, rear trunk**

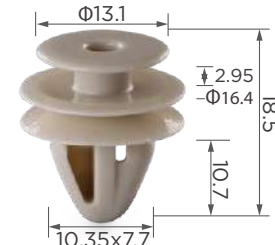

C1998

**Material:** POM  
**Color:** Light grey  
**Pillar**



C3009

**Material:** POM  
**Color:** White  
**Door panel**

# DOOR TRIM PANEL CLIP



C3015

**Material:** POM  
**Color:** Natural  
**Side moulding**

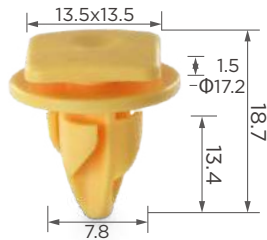

C3033

**Material:** POM  
**Color:** Yellow  
**Door panel**



C3042

**Material:** POM  
**Color:** Green  
**Door panel, pillar, rear tray**



C3063

**Material:** POM  
**Color:** Green  
**Door panel, pillar, roof**



C3070

**Material:** POM  
**Color:** Grey  
**Door panel**



C3083

**Material:** POM  
**Color:** White/ Green  
**Door panel, pillar**



C3087

**Material:** POM  
**Color:** Green  
**Door panel, pillar, rear tray**



C3088

**Material:** POM + PA  
**Color:** Yellow + Black  
**Rocker panel, side moulding**



C3089

**Material:** POM + PA  
**Color:** White + Black  
**Pillar, rear trunk**

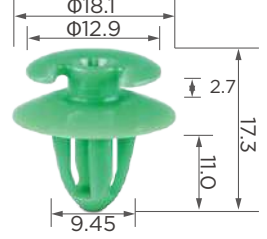

C3174

**Material:** POM  
**Color:** Green  
**Door panel**



C3190

**Material:** POM  
**Color:** Natural  
**Door panel**



C3209

**Material:** POM  
**Color:** Grey  
**Door panel**



C3220

**Material:** POM  
**Color:** Natural  
**Side moulding**



C3221

**Material:** POM  
**Color:** Yellow  
**Door panel, side moulding, rear tray**

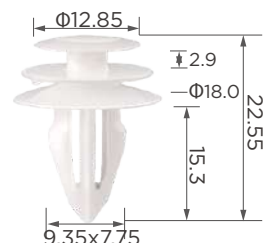

C3222

**Material:** POM  
**Color:** White  
**Cowl, rear panel**



C3225

**Material:** POM  
**Color:** White  
**Rear tray**

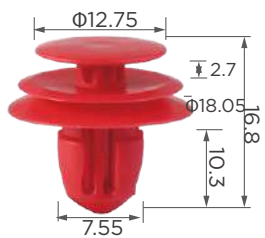

C3236

**Material:** POM  
**Color:** Red  
**Bumper, rear panel**



C3238

**Material:** POM  
**Color:** Natural  
**Hood**



C3259

**Material:** POM  
**Color:** Natural  
**Bumper, rear panel**

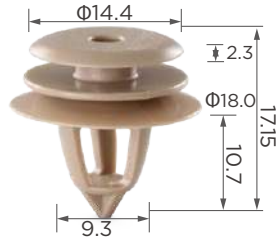

C3265

**Material:** POM  
**Color:** Brown  
**Door panel**

## DOOR TRIM PANEL CLIP



C3270

**Material:** POM  
**Color:** Green  
**Cowl panel, rear trunk**



C3286

**Material:** POM  
**Color:** Natural  
**Door panel**



C3291

**Material:** POM  
**Color:** Natural/ Grey  
**Door panel**



C3294

**Material:** POM  
**Color:** White/ Light blue  
**Roof**



C3303

**Material:** POM  
**Color:** Natural  
**Door panel, side moulding, rear trunk**

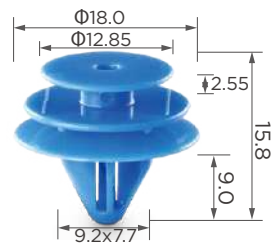

C3304

**Material:** POM  
**Color:** Blue  
**Side moulding**



C3311

**Material:** POM  
**Color:** White  
**Cowl**



C3313

**Material:** POM  
**Color:** Natural  
**Pillar, rear trunk**

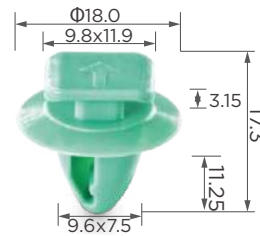

C3314

**Material:** POM  
**Color:** Green  
**Rocker panel**

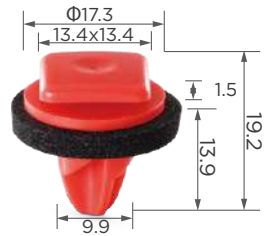

C3318

**Material:** POM  
**Color:** Red  
**Side moulding**



C3324

**Material:** POM  
**Color:** Natural  
**Rocker panel**



C3325

**Material:** PA  
**Color:** Black  
**Rear panel**



C3329

**Material:** POM  
**Color:** Natural  
**Door panel**



C3340

**Material:** POM  
**Color:** Grey  
**Door panel, pillar**

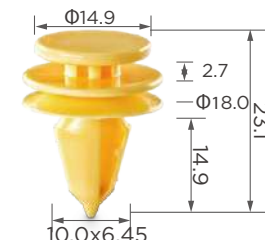

C3361

**Material:** POM  
**Color:** Yellow  
**Door panel**



C3373

**Material:** POM  
**Color:** Green  
**Rea trunk**



C3376

**Material:** POM  
**Color:** Purple  
**Door panel**

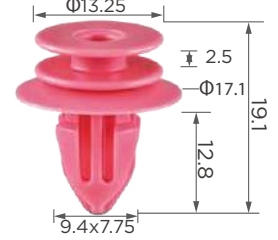

C3377

**Material:** POM  
**Color:** Pink  
**Door panel, front head, window**

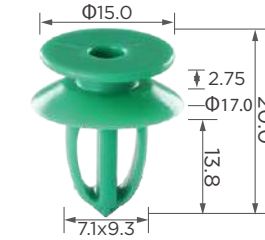

C3382

**Material:** POM  
**Color:** Green  
**Door panel**



C3405

**Material:** POM  
**Color:** Grey  
**Door panel, rear trunk**



# DOOR TRIM PANEL CLIP



C3427

**Material:** POM  
**Color:** Natural  
**Wiper system**



C3491

**Material:** POM  
**Color:** Natural  
**Door panel**

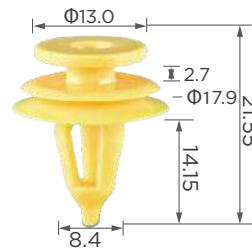

C3494

**Material:** POM  
**Color:** Yellow  
**Door panel**

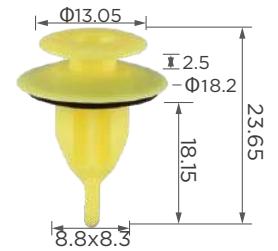

C3507

**Material:** POM  
**Color:** Yellow  
**Door panel**



C3513

**Material:** POM  
**Color:** White  
**Door panel**



C3524

**Material:** POM  
**Color:** Natural  
**Door panel**

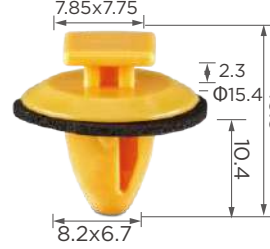

C3527

**Material:** POM  
**Color:** Yellow  
**Door panel**



C3535

**Material:** POM  
**Color:** Natural  
**Door panel, quarter panel**



C3537

**Material:** POM  
**Color:** Natural  
**Door panel**

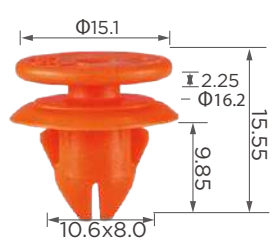

C3543

**Material:** POM  
**Color:** Orange  
**Fender flare**



C3555

**Material:** POM  
**Color:** Natural  
**Door panel**



C3558

**Material:** POM  
**Color:** Black  
**Door panel**



C3638

**Material:** Nylon  
**Color:** Green  
**Headlamp upper, fender**

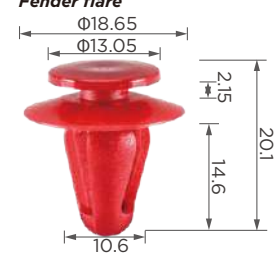

C3656

**Material:** Nylon  
**Color:** Red  
**Door panel**

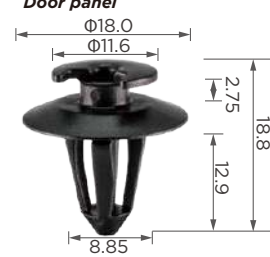

C3677

**Material:** POM  
**Color:** Black  
**Door panel**

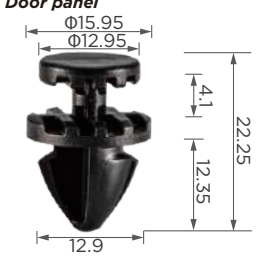

C3693

**Material:** POM  
**Color:** Black  
**Fender flare**



C3700

**Material:** POM  
**Color:** Dark grey  
**Door moulding, door panel**

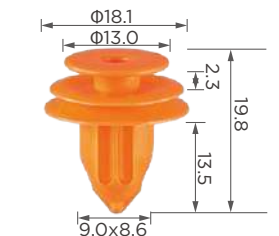

C3717

**Material:** POM  
**Color:** Orange  
**Rear quarter panel**



C3775

**Material:** POM  
**Color:** Black + Natural  
**Interior roof, pillar, rear tray**



C3778

**Material:** POM  
**Color:** Beige  
**Upholstery, floor mat**

# DOOR TRIM PANEL CLIP



C3784

**Material:** POM  
**Color:** Natural  
**Cowl, side molding, Front cover panel**



C3806

**Material:** POM  
**Color:** Natural  
**Door panel**



C3807

**Material:** POM  
**Color:** Natural  
**Door panel**



C3815

**Material:** POM  
**Color:** Natural  
**Door filler, mirror**



C3822

**Material:** POM  
**Color:** Natural  
**Rear liftgate, interior roof**

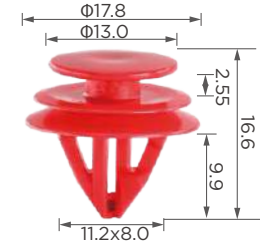

C3836

**Material:** POM  
**Color:** Red  
**Read light, pillar**

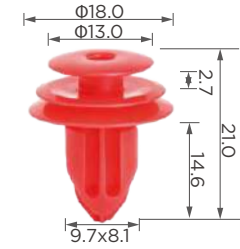

C3838

**Material:** POM  
**Color:** Red  
**Interior trunk panel, front bumper, pillar**



C3865

**Material:** POM  
**Color:** Black  
**Side molding, front bumper, pillar**



C3886

**Material:** POM  
**Color:** Natural  
**Door panel**



C3891

**Material:** POM  
**Color:** White  
**Side molding**



C3896

**Material:** POM+TPE  
**Color:** Grey  
**Rocker panel, side step, fender flare**

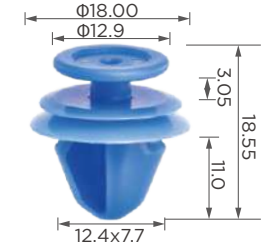

C3898

**Material:** POM  
**Color:** Blue  
**Side molding, rocker panel, rear tailgate**

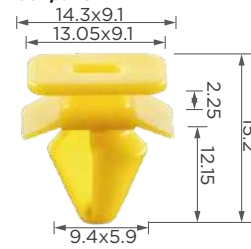

C3910

**Material:** POM  
**Color:** Yellow  
**Rocker panel**



C3971

**Material:** POM  
**Color:** Black  
**Door panel**



C3983

**Material:** POM  
**Color:** Natural  
**Fender flare, side skirt cover**



C4001

**Material:** PA  
**Color:** Natural  
**Door panel, liftgate interior trim**





# DOOR TRIM PANEL CLIP



C0064

**Material:** PA  
**Color:** White  
**Seat**



C0225

**Material:** POM  
**Color:** White  
**Door lower panel**



C0347

**Material:** POM  
**Color:** White + Yellow  
**Door panel**



C0355

**Material:** POM  
**Color:** White  
**Door panel**



C0385

**Material:** POM  
**Color:** White + Yellow  
**Door panel**

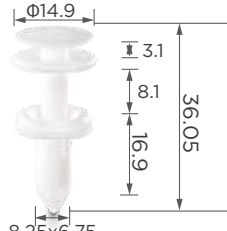

C0599

**Material:** POM  
**Color:** White  
**Door panel**

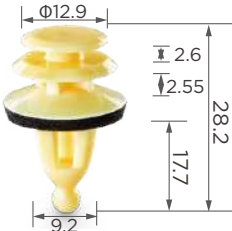

C0617

**Material:** POM  
**Color:** Yellow  
**Door panel**

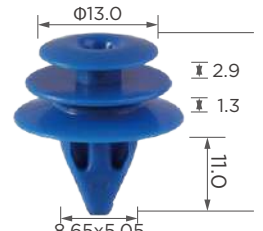

C1378

**Material:** POM  
**Color:** Blue  
**Door panel, rear trunk**

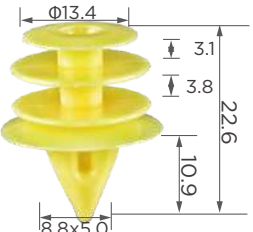

C1459

**Material:** POM  
**Color:** Yellow  
**Door panel**

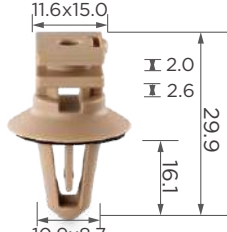

C1591

**Material:** PA  
**Color:** Brown  
**Rocker panel**



C1770

**Material:** POM  
**Color:** White  
**Door panel**



C1909

**Material:** POM  
**Color:** White  
**Door panel**

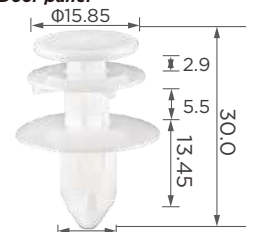

C1946

**Material:** POM  
**Color:** Natural  
**Door panel**



C3561

**Material:** POM  
**Color:** Natural+ Black  
**Door panel**

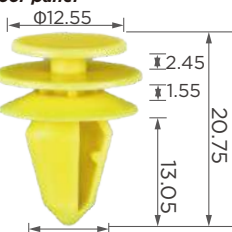

C3571

**Material:** PA  
**Color:** Yellow  
**Back door panel**



C3590

**Material:** POM  
**Color:** Natural + Black  
**Pillar**



C3824

**Material:** POM+PE  
**Color:** Natural+ Black  
**Door panel**



C3932

**Material:** POM+PA  
**Color:** Natural+Black  
**Rocker panel, side skirt cover**



C3969

**Material:** POM  
**Color:** Natural+Black  
**Pillar**

## DOOR TRIM PANEL CLIP

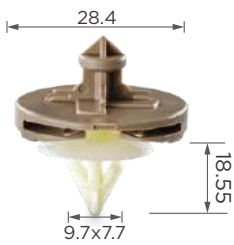
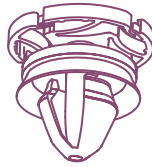

C0873

**Material:** POM  
**Color:** Grey + White  
**Door panel**



C0905

**Material:** PA  
**Color:** Black  
**Door panel**



C0907

**Material:** PA + POM  
**Color:** Black + Green  
**Door panel**



C0918

**Material:** PA  
**Color:** Black  
**Door panel**



C1249

**Material:** PA  
**Color:** Black  
**Door panel**



C1250

**Material:** PA  
**Color:** Black  
**Door panel**



C1393

**Material:** PA  
**Color:** Black+White  
**Door panel**



C1416

**Material:** POM + PA  
**Color:** Black+White  
**Door panel**



C1583

**Material:** PA  
**Color:** Black+White  
**Door panel**



C1689

**Material:** PA+POM  
**Color:** Black  
**Door panel**



C1728

**Material:** PA+POM  
**Color:** Black+White  
**Door panel**



C1761

**Material:** POM  
**Color:** White  
**Door panel**



C1848

**Material:** PA  
**Color:** Black  
**Pillar**



C3059

**Material:** POM  
**Color:** Black  
**Door panel**



C3203

**Material:** POM  
**Color:** Yellow+White  
**Door panel**



C3245

**Material:** POM  
**Color:** Black+White  
**Door panel**

## DOOR TRIM PANEL CLIP



C3287

**Material:** POM

**Color:** Yellow

**Door panel**



C3987

**Material:** POM

**Color:** Blue + Green

**Door panel**



C3647

**Material:** POM

**Color:** Natural + Black

**Door panel**

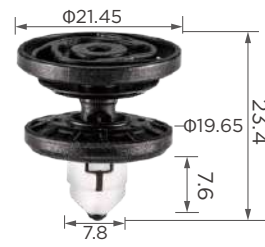

C3675

**Material:** POM

**Color:** Black + White

**Door panel**



C3883

**Material:** POM

**Color:** Natural + Black

**Rear spoiler**

## WEATHERSTRIP RETAINER

**Product No.:** C1503

**Material:** POM  
**Color:** Green/ White/ etc.  
**Position:** Front and rear door weatherstrip

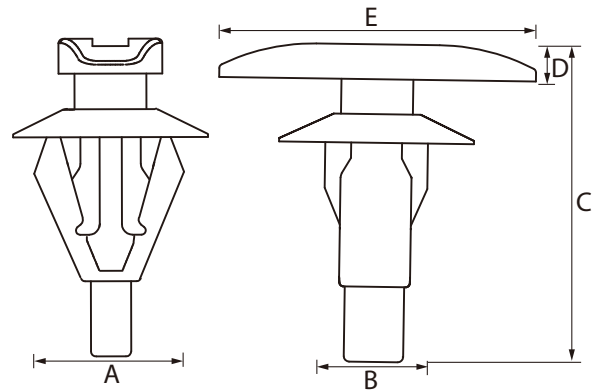
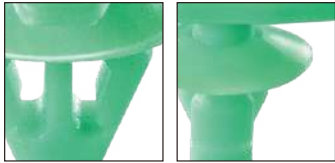

Part No.	Material	Color	mm					in				
			A	B	C	D	E	A	B	C	D	E
C0485	PA	White	5.50	3.10	12.70	1.60	16.15X6.8	0.215	0.121	0.495	0.062	0.630x0.265
C0590	POM	Black	5.65	3.80	10.50	0.85	9.70	0.220	0.148	0.410	0.033	0.378
C0607	PA	White	6.00	3.90	11.80	1.50	15.0X5.2	0.234	0.152	0.460	0.059	0.585x0.203
C0628	POM	Green	6.00	4.30	11.40	1.60	14.5X5.05	0.234	0.168	0.445	0.062	0.566x0.197
C3458	POM	Natural	6.10	4.30	10.85	1.60	15.05x5.0	0.238	0.168	0.423	0.062	0.587x0.195
C1472	PA	Black	6.20	4.25	10.60	1.50	11.0X5.1	0.242	0.166	0.413	0.059	0.429x0.199
C1788	PA	Yellow	6.20	4.55	9.45	1.20	12.7X5.1	0.242	0.177	0.369	0.047	0.495x0.199
C3805	POM	Natural	6.25	4.30	11.70	1.50	15.0x5.1	0.244	0.168	0.456	0.059	0.585x0.199
C0066	PA	Orange	6.35	4.40	11.25	1.50	14.9X4.85	0.248	0.172	0.439	0.059	0.589x0.189
C0068	PA	White	6.50	5.10	11.75	1.55	14.9X5.15	0.254	0.199	0.458	0.060	0.589x0.201
C3463	PA	Black	6.50	4.50	11.50	2.10	12.0x4.6	0.254	0.176	0.449	0.082	0.468x0.179
C0247	POM	White	6.55	4.80	14.90	1.65	14.75X5.1	0.255	0.187	0.581	0.064	0.575x0.199
C1505	POM	Yellow/ Natural	6.55	4.55	11.50	1.50	14.9X5.0	0.255	0.177	0.449	0.059	0.581x0.195
C0291	PA	Brown	6.75	4.82	10.00	1.50	12.9X5.2	0.263	0.188	0.390	0.059	0.503x0.203
C1799	POM	Natural	6.75	4.80	15.00	1.60	15.0X5.05	0.263	0.187	0.585	0.062	0.585x0.197
C1503	POM	Green/ Black/ Blue/ Natural	6.80	3.35	15.00	1.70	14.9X4.95	0.265	0.131	0.585	0.066	0.581x0.193
C3446	PA	Green	6.80	4.75	12.30	1.60	13.95x6.55	0.265	0.185	0.480	0.062	0.544x0.255
C0872	POM	Blue	6.90	5.00	13.60	1.60	15.9X6.65	0.269	0.195	0.530	0.062	0.620x0.259
C1965	POM	Red	6.90	4.75	9.40	1.50	15.0X5.0	0.269	0.185	0.367	0.059	0.585x0.195
C3305	PA	Natural/ Pink/ Yellow/ Blue	6.90	4.50	12.00	1.50	15.1X5.0	0.269	0.176	0.468	0.059	0.589x0.195
C3473	PA	Natural	6.90	4.55	12.00	1.45	11.1x5.05	0.269	0.177	0.468	0.057	0.433x0.197
C4014	PA	Green	7.00	4.20	12.40	1.60	15.0X5.0	0.273	0.164	0.484	0.062	0.585x0.195
C1501	POM	Natural	7.05	5.00	12.60	1.70	14.9X4.95	0.275	0.195	0.491	0.066	0.581x0.193
C3348	PA	Natural	7.10	4.80	12.40	1.50	14.0x6.6	0.277	0.187	0.484	0.059	0.546x0.257
C0035	POM	Black	7.15	2.50	16.00	1.60	14.3x5.0	0.279	0.098	0.624	0.062	0.558x0.195
C3632	POM	Natural	7.15	4.00	11.80	2.00	15.1x4.0	0.279	0.156	0.460	0.078	0.589x0.156
C1853	POM	Light blue	7.30	4.80	11.65	1.65	15.0X4.6	0.285	0.187	0.454	0.064	0.585x0.179
C3674	PP	White	7.85	5.00	14.70	1.40	16.0x6.55	0.306	0.195	0.573	0.055	0.624x0.255
C0812	PA	Black	9.00	5.10	14.55	1.80	17.1X8.1	0.351	0.199	0.567	0.070	0.668x0.316

# WEATHERSTRIP RETAINER



**C0035**  
**Material:** POM  
**Color:** Black  
*Front and rear door weatherstrip*



**C0066**  
**Material:** PA  
**Color:** Orange  
*Bonnet weatherstrip, front and rear door weatherstrip*



**C0068**  
**Material:** Nylon  
**Color:** White  
*Front and rear door weatherstrip*



**C0247**  
**Material:** POM  
**Color:** White  
*Front and rear door weatherstrip*



**C0291**  
**Material:** PA  
**Color:** Brown  
*Rear door weatherstrip, hood*



**C0485**  
**Material:** PA  
**Color:** White  
*Hood*



**C0590**  
**Material:** PA  
**Color:** Black  
*Front and rear door weatherstrip*



**C0607**  
**Material:** PA  
**Color:** White  
*Front and rear door weatherstrip, hood*



**C0628**  
**Material:** POM  
**Color:** Green  
*Instrument & side panel clip*



**C0812**  
**Material:** PA  
**Color:** Black  
*Front and rear door weatherstrip*

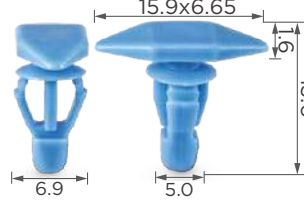

**C0872**  
**Material:** POM  
**Color:** Blue  
*Front and rear door weatherstrip, front bumper*



**C1472**  
**Material:** PA  
**Color:** Black  
*Rear door weatherstrip*



**C1501**  
**Material:** POM  
**Color:** Natural  
*Front and rear door weatherstrip*



**C1503**  
**Material:** POM  
**Color:** Green/ Black/Blue/ Natural  
*Front and rear door weatherstrip*



**C1505**  
**Material:** POM  
**Color:** Yellow/ Natural  
*Bonnet weatherstrip, front and rear door weatherstrip*



**C1788**  
**Material:** PA  
**Color:** Yellow  
*Front and rear door weatherstrip*

# WEATHERSTRIP RETAINER



C1799

**Material:** POM  
**Color:** Natural  
*Front and rear door weatherstrip, hood*

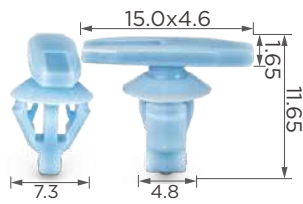

C1853

**Material:** POM  
**Color:** Light blue  
*Front and rear door weatherstrip*



C1965

**Material:** POM  
**Color:** Red  
*Door sill*



C3305

**Material:** PA  
**Color:** Natural/ Pink/ Yellow/ Blue  
*Door weatherstrip*



C3348

**Material:** PA  
**Color:** Natural  
*Front and rear door weatherstrip*



C3446

**Material:** PA  
**Color:** Green  
*Front and rear door weatherstrip*



C3458

**Material:** POM  
**Color:** Natural  
*Door weatherstrip*



C3463

**Material:** PA  
**Color:** Black  
*Rear door weatherstrip*



C3473

**Material:** PA  
**Color:** Natural  
*Bonnet weatherstrip, Rear door weatherstrip*

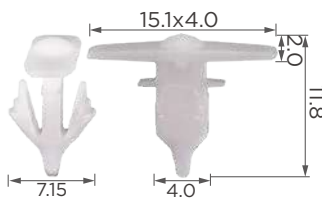

C3632

**Material:** PA  
**Color:** Natural  
*Door weatherstrip*



C3674

**Material:** PP  
**Color:** White  
*Door seal*



C3805

**Material:** POM  
**Color:** Natural  
*Door weatherstrip*



# WEATHERSTRIP RETAINER



C0816

**Material:** PA  
**Color:** White  
**Door weatherstrip**



C1214

**Material:** PA  
**Color:** Black  
**Door panel**



C1908

**Material:** PA  
**Color:** Black  
**Door weatherstrip**

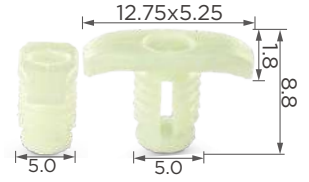

C1911

**Material:** PA  
**Color:** Light green  
**Door weatherstrip**



C3020

**Material:** PA  
**Color:** Red  
**Door weatherstrip**

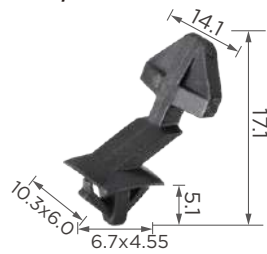

C3528

**Material:** PA  
**Color:** Black  
**Door weatherstrip**

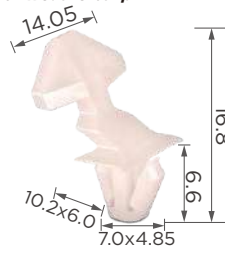

C3598

**Material:** POM  
**Color:** Natural  
**Door weatherstrip**



C3630

**Material:** PA  
**Color:** Grey  
**Door weatherstrip**

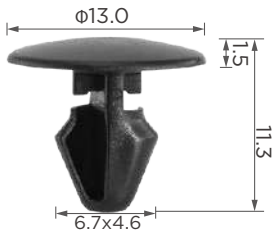

C3829

**Material:** POM  
**Color:** Black  
**Door weatherstrip**



C3831

**Material:** PA  
**Color:** Black  
**Front cover seal**

# — LOCK ROD CLIP

**Product No.: C0324**

**Material:** PA  
**Color:** Black  
**Position:** Door handle & door lock system

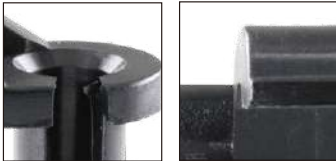

Product Details

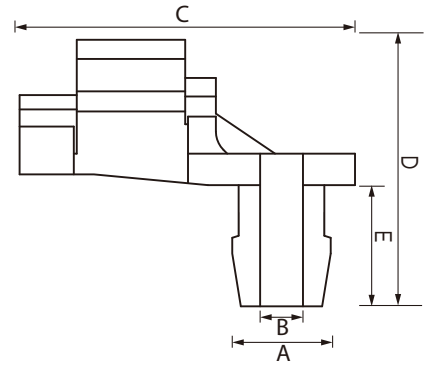

Part No.	Material	Color	mm					in				
			A	B	C	D	E	A	B	C	D	E
C0185	PA	Beige	6.80	4.45	23.70	18.70	10.90	0.265	0.174	0.924	0.729	0.425
C0324	PA	Black	6.90	4.40	23.50	18.70	10.70	0.269	0.172	0.917	0.729	0.417
C0329	PA	White	8.80	5.60	22.70	21.45	12.70	0.343	0.218	0.885	0.837	0.495
C0330	PA	Yellow	8.60	5.50	22.50	21.15	12.60	0.335	0.215	0.878	0.825	0.491
C0349	PA	White	9.65	5.00	23.20	17.85	10.60	0.376	0.195	0.905	0.696	0.413
C0350	PA	Yellow	9.50	5.00	22.80	17.60	10.45	0.371	0.195	0.889	0.686	0.408
C0367	PA	White	10.30	5.70	27.90	36.00	22.80	0.402	0.222	1.088	1.404	0.889
C0493	PA	Dark grey	7.60	4.30	23.30	15.10	8.80	0.296	0.168	0.909	0.589	0.343
C0494	PA	Blue	7.45	4.30	24.00	14.90	9.00	0.291	0.168	0.936	0.581	0.351
C0531	PA	Grey	7.00	4.30	23.50	17.30	9.80	0.273	0.168	0.917	0.675	0.382
C0616	PA	Light green	9.20	5.30	24.30	16.20	8.60	0.359	0.207	0.948	0.632	0.335
C0661	PA	Grey	7.70	3.80	35.30	18.45	9.75	0.300	0.148	1.377	0.720	0.380
C3210	PA	Black	7.80	4.70	18.00	14.20	9.25	0.304	0.183	0.702	0.554	0.361
C3490	PA	Black	11.70	7.20	28.00	31.60	11.10	0.456	0.281	1.092	1.232	0.433
C3614	PA	Black	7.20	3.00	17.86	15.35	6.80	0.281	0.117	0.697	0.599	0.265
C3615	PA	Light Pink	7.20	4.20	18.60	13.35	4.80	0.281	0.164	0.725	0.521	0.187

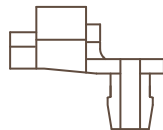

# LOCK ROD CLIP

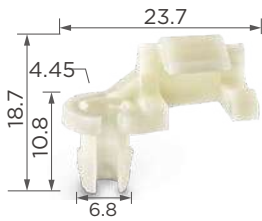

**C0185**  
**Material:** PA  
**Color:** Beige  
*Door handle & door lock system*

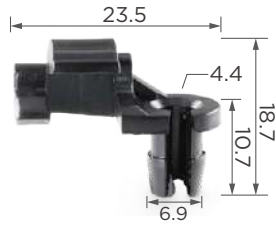

**C0324**  
**Material:** PA  
**Color:** Black  
*Door handle & door lock system*

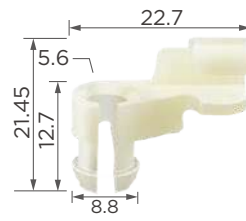

**C0329**  
**Material:** PA  
**Color:** White  
*Door handle & door lock system*

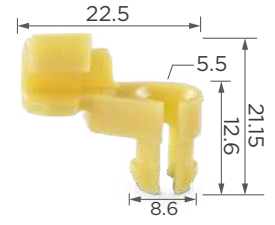

**C0330**  
**Material:** PA  
**Color:** Yellow  
*Door handle & door lock system*

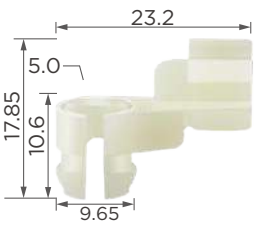

**C0349**  
**Material:** PA  
**Color:** White  
*Door handle & door lock system*

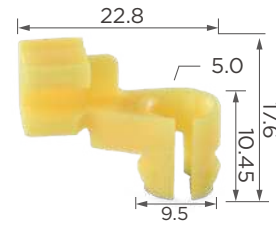

**C0350**  
**Material:** PA  
**Color:** Yellow  
*Door handle & door lock system*

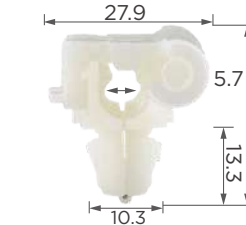

**C0367**  
**Material:** PA  
**Color:** White  
*Door handle & door lock system*



**C0493**  
**Material:** PA  
**Color:** Dark grey  
*Door handle & door lock system*

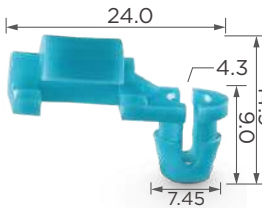

**C0494**  
**Material:** PA  
**Color:** Blue  
*Rear door panel*

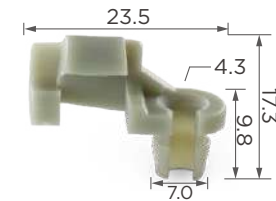

**C0531**  
**Material:** PA  
**Color:** Grey  
*Door panel, rear panel, fuel cap*



**C0616**  
**Material:** PA  
**Color:** Light green  
*Rear panel lock system*

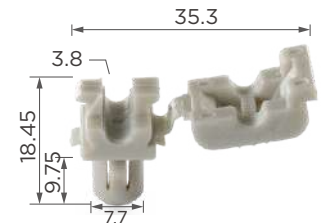

**C0661**  
**Material:** PA  
**Color:** Grey  
*Door handle & door lock system*



**C3210**  
**Material:** PA  
**Color:** Black  
*Instrument & side panel clip*



**C3490**  
**Material:** PA  
**Color:** Black  
*Bonnet stay rod guide*



**C3614**  
**Material:** PA  
**Color:** Black  
*Door lock rod*

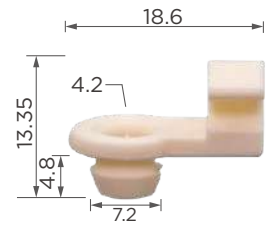

**C3615**  
**Material:** PA  
**Color:** Light pink  
*Door lock rod*

# HOOD SEAL CLIP

**Product No.:** C0010

**Material:** PA  
**Color:** Black  
**Position:** Cowl, hood



Product Details

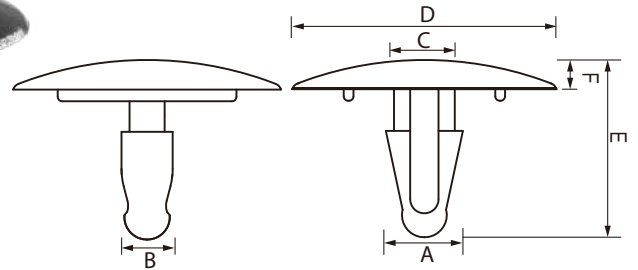

Part No.	Material	Color	mm						in					
			A	B	C	D	E	F	A	B	C	D	E	F
C3230	PA	Black	5.50	3.00	4.85	9.8x4.1	11.65	1.55	0.215	0.117	0.189	0.382x0.160	0.454	0.060
C0065	PA	White	6.20	3.70	5.20	16.15x6.8	14.00	2.10	0.242	0.144	0.203	0.630x0.265	0.546	0.082
C1855	PA	Black	6.20	3.90	4.30	10.9x4.3	11.70	1.40	0.242	0.152	0.168	0.425x0.168	0.456	0.055
C0009	PA	Black	6.95	3.60	5.00	12.80	17.10	1.80	0.271	0.140	0.195	0.499	0.667	0.070
C1085	PA	Black	6.95	4.25	5.55	15.80	17.85	2.20	0.271	0.166	0.216	0.616	0.696	0.086
C3478	POM	Black	7.10	3.30	6.05	16.55x6.45	13.80	1.50	0.277	0.129	0.236	0.645x0.252	0.538	0.059
C1398	TPE	Black	7.20	6.80	5.75	18.05	11.10	3.65	0.281	0.265	0.224	0.704	0.433	0.142
C0146	PA	Black	7.25	5.20	5.10	13.00	12.60	1.70	0.283	0.203	0.199	0.507	0.491	0.066
C0364	PA	Black	7.30	6.45	5.15	12.9x9.1	11.30	1.80	0.285	0.252	0.201	0.503x0.355	0.441	0.070
C0327	PA	White	7.50	5.30	5.30	12.40	17.00	2.20	0.293	0.207	0.207	0.484	0.663	0.086
C0589	PA	Grey	7.50	5.10	5.05	12.80	18.10	1.50	0.293	0.199	0.197	0.499	0.706	0.059
C1361	PA	Black	7.50	4.90	5.40	7.0x12.8	14.70	1.80	0.293	0.191	0.211	0.273x0.499	0.573	0.070
C0975	POM	White	7.55	6.85	6.10	19.8x10.4	17.55	2.60	0.294	0.267	0.238	0.772x0.406	0.684	0.101
C3872	PA	Black	7.90	4.80	3.05	18.3x10.1	13.30	1.95	0.308	0.187	0.119	0.714x0.394	0.519	0.076
C0119	PA	Black	8.00	5.00	5.95	29.60	21.75	2.70	0.312	0.195	0.232	1.154	0.848	0.105
C0612	PA	Black	8.20	6.00	6.85	30.00	18.85	4.30	0.320	0.234	0.267	1.170	0.735	0.168
C0620	PA	Black	8.30	7.45	6.75	24.95	14.30	2.70	0.324	0.291	0.263	0.973	0.558	0.105
C0098	PA	Black	8.60	6.20	6.65	14.90	22.85	3.00	0.335	0.242	0.259	0.581	0.891	0.117
C0010	PA	Black	8.70	5.70	6.90	29.85	19.90	3.30	0.339	0.222	0.269	1.164	0.776	0.129
C0619	PA	Black	8.70	3.65	7.00	29.60	18.10	2.42	0.339	0.142	0.273	1.154	0.706	0.094
C0522	PA	White	9.95	8.00	10.20	14.75x11.7	21.10	1.50	0.388	0.312	0.398	0.575x0.456	0.823	0.059

# HOOD SEAL CLIP

Product No.: C0077

**Material:** PA  
**Color:** Black  
**Position:** Hood insulation



Product Details

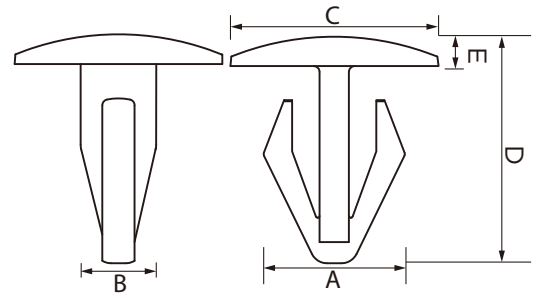

Part No.	Material	Color	mm					in				
			A	B	C	D	E	A	B	C	D	E
C1396	POM	Black	5.40	3.65	7.95	8.05	1.45	0.211	0.142	0.310	0.314	0.057
C1145	POM	Black	5.60	3.65	9.00	8.50	1.35	0.218	0.142	0.351	0.332	0.053
C1715	POM	Black	6.05	3.20	9.95	9.60	1.55	0.236	0.125	0.388	0.374	0.060
C0490	PA	Black	6.10	4.35	13.00	15.20	2.10	0.238	0.170	0.507	0.593	0.082
C0491	PA	Black	6.20	4.20	10.95	14.95	2.10	0.242	0.164	0.427	0.583	0.082
C1884	PA	Black	6.20	4.65	11.90	11.60	1.70	0.242	0.181	0.464	0.452	0.066
C1274	PA	Black	6.30	4.40	14.10	12.00	1.45	0.246	0.172	0.550	0.468	0.057
C3477	POM	Black	6.40	4.25	11.95	9.80	2.00	0.250	0.166	0.466	0.382	0.078
C1997	PA	Black	6.55	3.80	10.0x4.1	8.40	1.00	0.255	0.148	0.390x0.160	0.328	0.039
C0603	POM	Black	6.65	4.50	14.00	11.35	1.95	0.259	0.176	0.546	0.443	0.076
C0096	PA	Black	6.75	4.55	15.50	17.30	2.20	0.263	0.177	0.605	0.675	0.086
C1942	POM	Black	7.00	4.70	13.0x4.9	10.60	1.70	0.273	0.183	0.507x0.191	0.413	0.066
C3661	POM	Black	7.05	4.75	10.90	10.85	1.20	0.275	0.185	0.425	0.423	0.047
C0663	PA	Black	7.10	4.50	10.80	9.50	1.10	0.277	0.176	0.421	0.371	0.043
C3943	POM	Black	7.20	4.00	13.05x6.85	13.25	1.55	0.281	0.156	0.509x0.267	0.517	0.060
C1394	POM	Black	7.30	5.75	19.60	17.50	1.95	0.285	0.224	0.764	0.683	0.076
C1845	PA	Black	7.30	5.20	17.0x8.6	10.70	1.95	0.285	0.203	0.663x0.335	0.417	0.076
C1952	POM	Black	7.35	5.60	20.00	18.05	2.30	0.287	0.218	0.780	0.704	0.090
C0219	PA	Black	7.50	4.70	16.30	12.30	1.40	0.293	0.183	0.636	0.480	0.055
C0095	PA	Black	7.60	4.80	13.00	16.55	1.70	0.296	0.187	0.507	0.645	0.066
C0587	PA	Black	7.70	4.90	10.10	12.15	1.35	0.300	0.191	0.394	0.474	0.053
C1921	POM	Black	7.85	4.40	16.20	14.15	2.15	0.306	0.172	0.632	0.552	0.084
C0229	POM	Black	8.00	3.70	17.8x8.2	16.85	2.05	0.312	0.144	0.694x0.320	0.657	0.080
C3723	PA	Black	8.05	4.90	11.75	12.00	1.90	0.314	0.191	0.458	0.468	0.074
C0143	POM	Black	8.10	4.90	14.00	17.20	2.00	0.316	0.191	0.546	0.671	0.078
C1941	PA	Black	8.15	5.70	20.00	10.95	1.90	0.318	0.222	0.780	0.427	0.074
C3509	POM	Black	8.15	5.20	20.00	11.90	1.90	0.318	0.203	0.780	0.464	0.074
C0006	PA	Black	8.60	2.90	14.40	18.20	2.25	0.335	0.113	0.562	0.710	0.088
C0621	POM	Black	8.60	5.45	11.70	10.80	2.00	0.335	0.213	0.456	0.421	0.078
C1882	PA	Black	8.70	5.80	19.95	11.60	1.55	0.339	0.226	0.778	0.452	0.060
C0100	PA	Black	8.90	6.40	13.95x15.0	21.00	1.80	0.347	0.250	0.544x0.585	0.819	0.070

## HOOD SEAL CLIP

Part No.	Material	Color	mm					in				
			A	B	C	D	E	A	B	C	D	E
C0254	POM	Black	8.95	6.30	16.95x7.9	16.45	1.70	0.349	0.246	0.661x0.308	0.642	0.066
C3892	POM	Black	9.15	1.80	20.05	11.00	1.35	0.357	0.070	0.782	0.429	0.053
C0086	PA	Black	9.30	5.45	14.00	14.00	2.40	0.363	0.213	0.546	0.546	0.094
C1300	PA	Black	9.35	7.30	13.50	19.35	1.85	0.365	0.285	0.527	0.755	0.072
C0665	PA	Black	9.55	6.70	25.30	14.55	2.50	0.372	0.261	0.987	0.567	0.098
C0099	PA	Black	9.65	6.50	18.30	14.60	2.45	0.376	0.254	0.714	0.569	0.096
C1780	POM	Black	9.70	6.10	20.00	12.00	2.30	0.378	0.238	0.780	0.468	0.090
C0079	PA	Black, Dark brown	9.75	6.70	17.80	17.50	2.40	0.380	0.261	0.694	0.683	0.094
C1936	POM	Black	10.40	5.85	16.00	12.10	1.45	0.406	0.228	0.624	0.472	0.057
C3344	POM	Black	10.70	6.30	20.10	17.75	2.80	0.417	0.246	0.784	0.692	0.109
C0363	PA	Black	10.75	6.50	34.80	17.70	3.00	0.419	0.254	1.357	0.690	0.117
C0492	PA	Black, Light brown	10.90	5.80	19.80	19.10	2.40	0.425	0.226	0.772	0.745	0.094
C0352	PA	Black	11.50	8.00	26.50	15.60	2.60	0.449	0.312	1.034	0.608	0.101
C0540	PA	Black	12.00	7.50	18.20	18.80	3.00	0.468	0.293	0.710	0.733	0.117
C0077	PA	Black	12.30	6.85	18.00	19.60	2.45	0.480	0.267	0.702	0.764	0.096
C0094	PA	Black	12.30	8.00	15.10	18.90	2.80	0.480	0.312	0.589	0.737	0.109
C3787	PA	Black	12.80	2.10	25.30	15.70	2.80	0.499	0.082	0.987	0.612	0.109
C0093	PA	Black	13.50	8.00	18.00	17.85	2.50	0.527	0.312	0.702	0.696	0.098
C0964	PA	Black	14.30	7.80	20.30	13.40	3.70	0.558	0.304	0.792	0.523	0.144
C3296	PA	Black	15.30	7.80	21.00	19.40	3.50	0.597	0.304	0.819	0.757	0.137
C3297	PA	Black	15.30	7.80	21.00	15.40	3.50	0.597	0.304	0.819	0.601	0.137
C0087	PA	Black	19.50	7.30	19.95	22.85	2.85	0.761	0.285	0.778	0.891	0.111

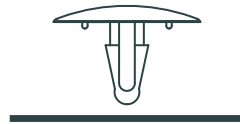

**C0009**  
**Material:** PA  
**Color:** Black  
**Cowl, hood**



**C0010**  
**Material:** PA  
**Color:** Black  
**Cowl, hood**



**C0065**  
**Material:** PA  
**Color:** White  
**Hood**



**C0098**  
**Material:** PA  
**Color:** Black  
**Clip**



# HOOD SEAL CLIP



C0119

**Material:** PA  
**Color:** Black

**Rear tray**



C0522

**Material:** PA  
**Color:** White  
**Grille, rocker panel**



C0620

**Material:** PA  
**Color:** Black  
**Hood, fender**



C1398

**Material:** TPE  
**Color:** Black  
**Clip**



C3872

**Material:** PA  
**Color:** Black  
**Weatherstrip**



C0146

**Material:** PA  
**Color:** Black

**Hood**



C0589

**Material:** PA  
**Color:** Grey  
**Cowl, hood**



C0975

**Material:** POM  
**Color:** White  
**Wheelarch**



C1855

**Material:** PA  
**Color:** Black  
**Grille**



C0327

**Material:** PA  
**Color:** White  
**Pillar garnish, floor attachment, door panel**



C0612

**Material:** PA  
**Color:** Black  
**Hood**



C1085

**Material:** PA  
**Color:** Black  
**Clip**



C3230

**Material:** PA  
**Color:** Black  
**Door panel**



C0364

**Material:** PA  
**Color:** Black  
**Hood, splash guard**



C0619

**Material:** PA  
**Color:** Black  
**Hood, floor attachment**



C1361

**Material:** PA  
**Color:** Black  
**Clip**



C3478

**Material:** POM  
**Color:** Black  
**Grille**

# HOOD SEAL CLIP



C0006

**Material:** PA  
**Color:** Black  
**Cowl, grille**



C0077

**Material:** PA  
**Color:** Black  
**Hood insulation**



C0079

**Material:** PA  
**Color:** Black, Dark brown  
**Cowl, hood**



C0086

**Material:** PA  
**Color:** Black  
**Clip**



C0087

**Material:** PA  
**Color:** Black  
**Clip**



C0093

**Material:** PA  
**Color:** Black  
**Clip**



C0094

**Material:** PA  
**Color:** Black  
**Splash guard**



C0095

**Material:** PA  
**Color:** Black  
**Cowl, hood**



C0096

**Material:** PA  
**Color:** Black  
**Hood ledge**



C0099

**Material:** PA  
**Color:** Black  
**Seat, rear tray**



C0100

**Material:** PA  
**Color:** Black  
**Quarter vent duct, rood heading**

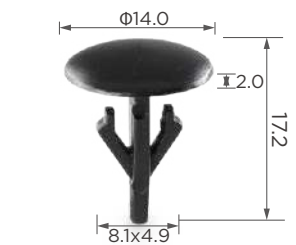

C0143

**Material:** POM  
**Color:** Black  
**Cowl, hood**



C0219

**Material:** PA  
**Color:** Black  
**Pillar garnish**



C0229

**Material:** POM  
**Color:** Black  
**Cowl, hood**



C0254

**Material:** POM  
**Color:** Black  
**Cowl**



C0352

**Material:** PA  
**Color:** Black  
**Hood**

# HOOD SEAL CLIP

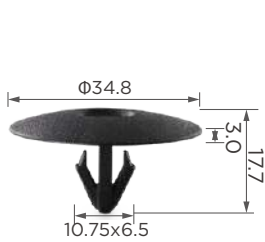

C0363

**Material:** PA  
**Color:** Black  
**Clip**



C0490

**Material:** PA  
**Color:** Black  
**Hood**



C0491

**Material:** PA  
**Color:** Black  
**Wire, front skirt**



C0492

**Material:** PA  
**Color:** Black, Light brown  
**Foot mat**



C0540

**Material:** PA  
**Color:** Black  
**Fuel tank tube**



C0587

**Material:** PA  
**Color:** Black  
**Hood**



C0603

**Material:** POM  
**Color:** Black  
**Hood**



C0621

**Material:** POM  
**Color:** Black  
**Hood**



C0663

**Material:** PA  
**Color:** Black  
**Hood**



C0665

**Material:** PA  
**Color:** Black  
**Hood, seat**



C0964

**Material:** PA  
**Color:** Black  
**Hood, antinoise capsule**



C1145

**Material:** POM  
**Color:** Black  
**Door panel**



C1274

**Material:** PA  
**Color:** Black  
**Hood**



C1300

**Material:** PA  
**Color:** Black  
**Side moulding, rear panel, seat**



C1394

**Material:** POM  
**Color:** Black  
**Splash guard, wipe system, cowl**



C1396

**Material:** POM  
**Color:** Black  
**Door panel**



C1715

**Material:** POM  
**Color:** Black  
**Hood**



C1780

**Material:** POM  
**Color:** Black  
**Fender**



C1845

**Material:** PA  
**Color:** Black  
**Side moulding**



C1882

**Material:** PA  
**Color:** Black  
**Hood, rear panel**

# HOOD SEAL CLIP



C1884

**Material:** PA  
**Color:** Black  
**Door panel**

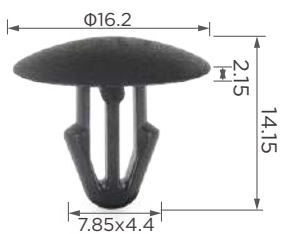

C1921

**Material:** POM  
**Color:** Black  
**Grille**



C1936

**Material:** POM  
**Color:** Black  
**Wheelarch**



C1941

**Material:** PA  
**Color:** Black  
**Floor attachment, hood, fender**



C1942

**Material:** POM  
**Color:** Black  
**Hood, fender**



C1952

**Material:** POM  
**Color:** Black  
**Wiper system, wheelarch**



C1997

**Material:** PA  
**Color:** Black  
**Door panel**



C3296

**Material:** PA  
**Color:** Black  
**Clip**



C3297

**Material:** PA  
**Color:** Black  
**Clip**



C3344

**Material:** POM  
**Color:** Black  
**Liftgate**



C3477

**Material:** POM  
**Color:** Black  
**Grille**



C3509

**Material:** POM  
**Color:** Black  
**Floor attachment**



C3661

**Material:** POM  
**Color:** Black  
**Rocker panel, splash guard, hood**



C3723

**Material:** PA  
**Color:** Black  
**Wheel heat shield**



C3787

**Material:** PA  
**Color:** Black  
**Carpet**



C3892

**Material:** PA  
**Color:** Black  
**Fender protector**



C3943

**Material:** POM  
**Color:** Black  
**Window upper guide seal**

# HOOD SEAL CLIP



C0217

**Material:** PA  
**Color:** Grey  
**Hood insulation, door seal**



C0272

**Material:** PA  
**Color:** Black  
**Hood insulation**



C1132

**Material:** PA  
**Color:** Black  
**Hood insulation**



C0552

**Material:** PA  
**Color:** Black  
**Hood insulation**



C0610

**Material:** PP  
**Color:** Black  
**Hood insulation**



C0627

**Material:** PA  
**Color:** Black  
**Hood insulation, hood inner panel**



C0660

**Material:** PP  
**Color:** Black  
**Hood insulation**



C0818

**Material:** PA  
**Color:** Black  
**Hood insulation**



C0867

**Material:** PA  
**Color:** Black  
**Hood insulation, headlight**



C3949

**Material:** PP  
**Color:** Black  
**Hood insulation**



C0608

**Material:** PA  
**Color:** Black  
**Hood insulation**



C0830

**Material:** PA  
**Color:** Black  
**Hood insulation**



C3090

**Material:** PA  
**Color:** Black  
**Hood insulation**



C3092

**Material:** PA  
**Color:** Black  
**Hood insulation**



C1021

**Material:** PA  
**Color:** Black  
**Hood insulation, air filter, silencer**



C1897

**Material:** PA  
**Color:** Black  
**Hood insulation**

# HOOD SEAL CLIP



C1413

**Material:** PA  
**Color:** Black  
*Hood insulation, rear tray*



C3000

**Material:** POM  
**Color:** Black  
*Hood insulation*



C3018

**Material:** POM  
**Color:** Black  
*Hood insulation*

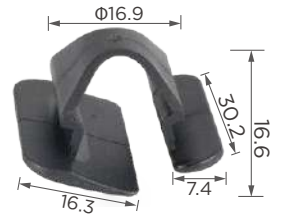

C3169

**Material:** PA  
**Color:** Black  
*Hood insulation*



C3178

**Material:** PA  
**Color:** Black  
*Splash shield, underbody, silencer*



C3242

**Material:** PA  
**Color:** Black  
*Hood insulation*



C0844

**Material:** PA  
**Color:** Black  
*Hood insulation*



C1694

**Material:** PA  
**Color:** Black  
*Hood insulation*



## SIDE MOULDING CLIP

**Product No.:** C0228

**Material:** POM  
**Color:** Orange  
**Position:** Side moulding

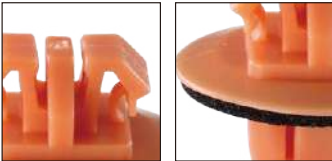

Product Details

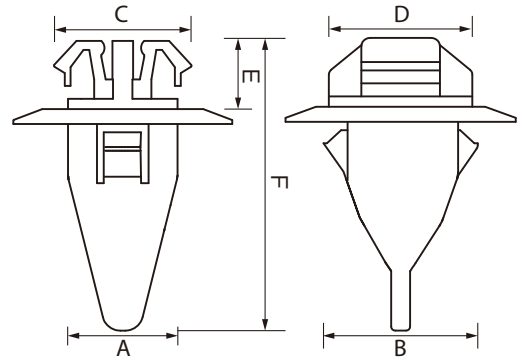

Part No.	Material	Color	mm						in					
			A	B	C	D	E	F	A	B	C	D	E	F
C0227	POM	Blue	8.40	11.25	8.50	5.80	6.50	16.70	0.328	0.439	0.332	0.226	0.254	0.651
C0228	POM	Orange	8.50	10.60	10.69	5.80	6.45	22.50	0.332	0.413	0.417	0.226	0.252	0.878
C0378	POM	White	8.70	11.30	8.90	7.70	7.90	18.20	0.339	0.441	0.347	0.300	0.308	0.710
C0380	POM	Pink	8.35	10.00	8.50	8.50	7.50	17.60	0.326	0.390	0.332	0.332	0.293	0.686
C0689	POM	Blue	8.30	11.25	10.60	10.45	6.00	24.60	0.324	0.439	0.413	0.408	0.234	0.959
C0690	POM	Red	8.35	11.00	8.40	5.90	6.20	20.70	0.326	0.429	0.328	0.230	0.242	0.807
C0695	POM	Yellow	8.60	11.10	10.60	10.50	7.00	24.70	0.335	0.433	0.413	0.410	0.273	0.963
C0804	POM	Grey	10.45	14.30	6.60	6.70	7.20	18.70	0.408	0.558	0.257	0.261	0.281	0.729
C0805	POM	Green	8.00	7.15	8.00	7.70	5.10	20.60	0.312	0.279	0.312	0.300	0.199	0.803
C0806	POM	Blue	7.10	10.60	7.70	6.90	7.20	29.60	0.277	0.413	0.300	0.269	0.281	1.154
C0807	POM	Grey	7.30	10.65	8.75	7.70	6.70	30.00	0.285	0.415	0.341	0.300	0.261	1.170
C0850	POM	Grey	9.50	5.85	8.70	7.93	6.70	16.70	0.371	0.228	0.339	0.309	0.261	0.651
C1088	POM	Yellow	7.00	10.90	8.00	7.50	4.90	20.00	0.273	0.425	0.312	0.293	0.191	0.780
C1089	POM	Dark pink	7.20	10.80	8.75	7.50	5.85	30.00	0.281	0.421	0.341	0.293	0.228	1.170
C1090	POM	Yellow	7.40	10.50	8.80	7.50	6.90	28.20	0.289	0.410	0.343	0.293	0.269	1.100
C1091	POM	Green	7.45	10.80	8.80	7.60	6.90	28.15	0.291	0.421	0.343	0.296	0.269	1.098
C1092	POM	Orange	6.75	10.50	8.60	6.80	7.80	24.90	0.263	0.410	0.335	0.265	0.304	0.971
C1093	POM	Black	7.60	11.30	8.70	7.55	7.20	24.15	0.296	0.441	0.339	0.294	0.281	0.942
C1438	POM	White	10.40	7.70	9.50	7.65	9.40	22.50	0.406	0.300	0.371	0.298	0.367	0.878
C1824	POM	White	12.40	8.10	10.90	8.00	11.20	24.05	0.484	0.316	0.425	0.312	0.437	0.938
C3016	POM	Yellow	8.20	11.40	16.00	10.25	6.40	27.25	0.320	0.445	0.624	0.400	0.250	1.063
C3409	POM	Natural	8.80	5.90	7.85	7.80	6.55	16.40	0.343	0.230	0.306	0.304	0.255	0.640
C3503	POM	Natural	11.45	8.90	7.55	7.10	6.27	19.80	0.447	0.347	0.294	0.277	0.245	0.772
C3584	PA	Milk white	12.20	8.65	10.00	7.95	8.10	18.60	0.476	0.337	0.390	0.310	0.316	0.725

## SIDE MOULDING CLIP

**Product No.: C1152**

**Material:** POM  
**Color:** Blue  
**Position:** Rocker panel

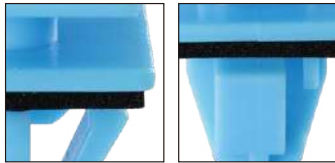

Product Details

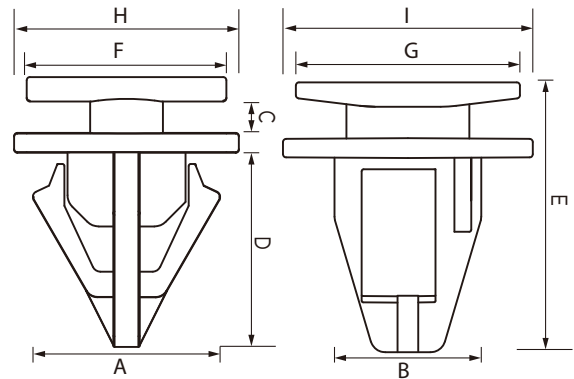

Part No.	Material	Color	mm									in								
			A	B	C	D	E	F	G	H	I	A	B	C	D	E	F	G	H	I
C0289	POM	White	15.20	11.40	2.00	20.20	34.65	19.60	19.70	20.00	20.00	0.593	0.445	0.078	0.788	1.351	0.764	0.768	0.780	0.780
C0336	POM	White	13.00	7.80	2.80	14.05	20.05	20.00	16.20	20.00	21.30	0.507	0.304	0.109	0.548	0.782	0.780	0.632	0.780	0.831
C0342	POM	White	12.90	7.75	2.85	15.90	20.10	20.10	13.90	20.00	21.20	0.503	0.302	0.111	0.620	0.784	0.784	0.542	0.780	0.827
C0360	POM	Black	13.50	9.10	1.50	10.85	14.70	9.05	8.20	17.90	14.00	0.527	0.355	0.059	0.423	0.573	0.353	0.320	0.698	0.546
C0361	POM	Yellow	12.90	9.20	2.00	9.95	14.75	19.70	15.80	14.40	17.80	0.503	0.359	0.078	0.388	0.575	0.768	0.616	0.562	0.694
C0388	POM	Grey	13.50	7.60	2.30	32.40	39.50	37.90	17.50	39.65	21.50	0.527	0.296	0.090	1.264	1.541	1.478	0.683	1.546	0.839
C0673	POM	Grey/ Natural	13.00	7.85	2.45	14.10	19.90	20.30	16.25	20.30	16.25	0.507	0.306	0.096	0.550	0.776	0.792	0.634	0.792	0.634
C0693	POM	White	10.30	5.75	3.60	7.80	13.90	5.20	7.70	11.90	8.70	0.402	0.224	0.140	0.304	0.542	0.203	0.300	0.464	0.339
C0828	POM	White	14.15	9.00	2.15	9.90	14.40	11.90	8.80	13.80	19.80	0.552	0.351	0.084	0.386	0.562	0.464	0.343	0.538	0.772
C0857	POM	White	9.00	7.90	1.60	13.70	18.30	11.90	11.95	10.00	9.80	0.351	0.308	0.062	0.534	0.714	0.464	0.466	0.390	0.382
C0889	POM	White	14.60	9.40	2.30	10.00	14.70	15.00	10.00	18.10	16.00	0.569	0.367	0.090	0.390	0.573	0.585	0.390	0.706	0.624
C0958	POM	White	12.70	8.00	2.70	14.20	21.70	21.30	12.00	19.90	12.00	0.495	0.312	0.105	0.554	0.846	0.831	0.468	0.776	0.468
C0969	POM	Yellow	14.00	9.25	2.15	9.80	14.55	11.00	9.80	13.80	19.10	0.546	0.361	0.084	0.382	0.567	0.429	0.382	0.538	0.745
C0983	POM	Light Blue	13.80	6.80	2.20	8.65	14.75	21.30	14.40	18.10	21.80	0.538	0.265	0.086	0.337	0.575	0.831	0.562	0.706	0.850
C0988	POM	White	14.15	9.40	2.00	14.50	19.00	9.95	11.00	25.90	14.00	0.552	0.367	0.078	0.566	0.741	0.388	0.429	1.010	0.546
C1152	POM	Blue	15.00	11.70	2.50	15.47	21.50	17.90	16.00	18.00	20.00	0.585	0.456	0.098	0.603	0.839	0.698	0.624	0.702	0.780
C1181	POM	White	13.40	9.60	6.85	11.00	17.90	10.65	23.80	21.00	27.10	0.523	0.374	0.267	0.429	0.698	0.415	0.928	0.819	1.057
C1188	POM	Yellow	13.00	7.00	3.00	34.85	42.55	21.20	12.00	20.05	12.00	0.507	0.273	0.117	1.359	1.659	0.827	0.468	0.782	0.468
C1199	POM	White	12.75	9.70	1.90	11.35	15.70	7.40	9.90	9.80	9.90	0.497	0.378	0.074	0.443	0.612	0.289	0.386	0.382	0.386
C1248	POM	White	5.30	6.00	1.10	5.55	8.65	10.60	7.30	9.10	8.00	0.207	0.234	0.043	0.216	0.337	0.413	0.285	0.355	0.312
C1271	POM	White/ Natural	12.40	8.10	2.60	14.40	19.75	19.85	12.10	23.95	12.10	0.484	0.316	0.101	0.562	0.770	0.774	0.472	0.934	0.472
C1280	POM	Black	11.50	8.10	2.35	7.60	14.10	10.20	8.00	14.10	10.15	0.449	0.316	0.092	0.296	0.550	0.398	0.312	0.550	0.396
C1315	POM	Red	14.30	9.30	2.00	10.30	14.50	12.70	10.95	19.15	11.98	0.558	0.363	0.078	0.402	0.566	0.495	0.427	0.747	0.467
C1325	PA	White	12.00	8.20	2.30	9.25	14.60	10.08	7.10	14.85	14.85	0.468	0.320	0.090	0.361	0.569	0.393	0.277	0.579	0.579
C1489	POM	White	12.20	8.00	2.50	14.70	29.20	26.80	14.10	26.30	13.30	0.476	0.312	0.098	0.573	1.139	1.045	0.550	1.026	0.519
C1513	POM	White	13.00	7.90	2.95	15.70	22.70	26.60	19.90	16.00	30.10	0.507	0.308	0.115	0.612	0.885	1.037	0.776	0.624	1.174
C1519	POM	White	13.15	8.00	2.65	15.25	21.00	11.90	19.95	11.90	32.20	0.513	0.312	0.103	0.595	0.819	0.464	0.778	0.464	1.256
C1523	POM	White	14.00	9.80	3.30	11.80	22.80	13.00	15.00	23.75	20.00	0.546	0.382	0.129	0.460	0.889	0.507	0.585	0.926	0.780
C1524	POM	White	15.40	11.70	2.90	20.80	27.90	18.00	15.90	19.70	19.75	0.601	0.456	0.113	0.811	1.088	0.702	0.620	0.768	0.770
C1540	POM	Yellow/ Blue	12.90	8.10	2.80	14.25	20.30	19.95	14.10	20.25	16.30	0.503	0.316	0.109	0.556	0.792	0.778	0.550	0.790	0.636

## SIDE MOULDING CLIP

Part No.	Material	Color	mm									in								
			A	B	C	D	E	F	G	H	I	A	B	C	D	E	F	G	H	I
C1541	POM	White	13.00	7.90	2.50	11.10	16.95	20.00	11.80	20.20	14.00	0.507	0.308	0.098	0.433	0.661	0.780	0.460	0.788	0.546
C1603	POM	Grey	13.50	8.10	3.00	14.70	20.75	29.10	15.05	29.10	15.05	0.527	0.316	0.117	0.573	0.809	1.135	0.587	1.135	0.587
C1604	POM	White	13.90	7.95	2.30	15.80	21.40	14.05	20.05	14.20	18.00	0.542	0.310	0.090	0.616	0.835	0.548	0.782	0.554	0.702
C1605	POM	Grey	12.25	8.40	2.75	15.00	20.85	20.00	11.90	20.00	14.00	0.478	0.328	0.107	0.585	0.813	0.780	0.464	0.780	0.546
C1606	POM	Natural	11.95	8.05	2.97	10.60	16.20	20.00	11.90	20.00	12.10	0.466	0.314	0.116	0.413	0.632	0.780	0.464	0.780	0.472
C1607	POM	Green	10.40	5.45	2.40	12.60	18.60	11.10	7.60	15.20	15.20	0.406	0.213	0.094	0.491	0.725	0.433	0.296	0.593	0.593
C1615	POM	White	15.45	12.50	1.50	15.15	18.35	8.00	12.50	18.10	18.10	0.603	0.488	0.059	0.591	0.716	0.312	0.488	0.706	0.706
C1624	POM	White	12.10	8.00	2.35	10.35	15.90	18.00	14.10	18.00	19.30	0.472	0.312	0.092	0.404	0.620	0.702	0.550	0.702	0.753
C1626	POM	White	13.60	8.15	2.30	15.10	20.90	20.35	12.10	20.35	15.05	0.530	0.318	0.090	0.589	0.815	0.794	0.472	0.794	0.587
C1627	POM	Grey	12.25	7.95	2.70	10.60	16.05	20.30	12.10	20.30	12.10	0.478	0.310	0.105	0.413	0.626	0.792	0.472	0.792	0.472
C1637	POM	White	13.70	10.00	1.50	11.20	15.15	9.90	11.85	13.00	15.35	0.534	0.390	0.059	0.437	0.591	0.386	0.462	0.507	0.599
C1658	POM	White	14.60	9.00	2.30	9.95	14.60	9.90	11.85	17.90	14.00	0.569	0.351	0.090	0.388	0.569	0.386	0.462	0.698	0.546
C1680	POM	White	13.20	8.10	3.10	14.00	20.70	26.30	15.10	26.30	19.00	0.515	0.316	0.121	0.546	0.807	1.026	0.589	1.026	0.741
C1685	POM	White	12.35	8.15	2.80	10.25	16.25	20.15	15.00	24.20	20.10	0.482	0.318	0.109	0.400	0.634	0.786	0.585	0.944	0.784
C1697	POM	White	14.60	9.00	2.15	9.90	14.50	9.65	10.65	14.05	17.90	0.569	0.351	0.084	0.386	0.566	0.376	0.415	0.548	0.698
C1698	POM	Blue	15.00	9.25	2.15	9.95	14.45	10.15	11.95	20.15	14.25	0.585	0.361	0.084	0.388	0.564	0.396	0.466	0.786	0.556
C1716	POM	White	10.45	7.80	1.80	6.40	11.50	6.05	9.25	12.90	12.90	0.408	0.304	0.070	0.250	0.449	0.236	0.361	0.503	0.503
C1724	POM	Black	11.00	5.95	3.60	10.30	16.90	21.50	22.00	21.50	22.00	0.429	0.232	0.140	0.402	0.659	0.839	0.858	0.839	0.858
C1727	POM	White	12.15	7.90	1.80	10.55	15.00	18.10	15.10	18.10	14.10	0.474	0.308	0.070	0.411	0.585	0.706	0.589	0.706	0.550
C1758	POM	Natural	12.80	9.50	2.20	8.65	15.00	14.85	9.90	17.00	17.00	0.499	0.371	0.086	0.337	0.585	0.579	0.386	0.663	0.663
C1792	POM	White	10.60	8.00	1.65	12.65	16.50	18.10	18.30	15.10	15.10	0.413	0.312	0.064	0.493	0.644	0.706	0.714	0.589	0.589
C1793	POM	Black	21.70	5.00	2.60	19.80	25.90	32.00	11.00	20.10	15.00	0.846	0.195	0.101	0.772	1.010	1.248	0.429	0.784	0.585
C1828	POM	Yellow	11.30	7.05	2.00	15.65	21.40	16.10	19.85	14.85	14.85	0.441	0.275	0.078	0.610	0.835	0.628	0.774	0.579	0.579
C1832	POM	White	14.00	9.20	1.90	8.85	13.45	13.05	10.15	17.30	9.80	0.546	0.359	0.074	0.345	0.525	0.509	0.396	/	/
C1901	POM	White	13.30	8.00	2.95	14.70	20.00	14.20	18.10	18.10	18.15	0.519	0.312	0.115	0.573	0.780	0.554	0.706	0.706	0.708
C1902	PA+POM	White	8.70	6.00	2.40	8.50	13.20	13.52	13.00	12.30	14.00	0.339	0.234	0.094	0.332	0.515	0.527	0.507	0.480	0.546
C1923	POM	White	13.00	9.90	2.80	7.45	17.90	15.75	17.90	20.20	21.95	0.507	0.386	0.109	0.291	0.698	0.614	0.698	0.788	0.856
C1947	POM	White	12.10	7.90	2.50	11.40	16.80	13.70	20.05	20.60	20.05	0.472	0.308	0.098	0.445	0.655	0.534	0.782	0.803	0.782
C1956	POM	Yellow	13.80	9.25	1.95	16.95	21.15	12.10	11.80	14.10	20.10	0.538	0.361	0.076	0.661	0.825	0.472	0.460	0.550	0.784
C1957	POM	Yellow	14.20	9.45	2.25	15.45	19.70	12.20	12.05	14.10	18.25	0.554	0.369	0.088	0.603	0.768	0.476	0.470	0.550	0.712
C1961	POM	Blue	14.15	9.15	2.10	10.00	15.70	17.90	14.00	20.05	15.95	0.552	0.357	0.082	0.390	0.612	0.698	0.546	0.782	0.622
C1970	POM	White	6.50	6.40	1.55	8.90	13.45	10.00	7.40	13.90	9.90	0.254	0.250	0.060	0.347	0.525	0.390	0.289	0.542	0.386
C1985	POM	Grey	11.95	9.60	2.10	8.80	15.30	10.05	15.05	18.00	18.00	0.466	0.374	0.082	0.343	0.597	0.392	0.587	0.702	0.702
C3013	PA	Black+lightgreen	13.70	10.00	2.00	16.70	23.50	14.80	13.00	21.20	21.20	0.534	0.390	0.078	0.651	0.917	0.577	0.507	0.827	0.827
C3037	PA	White	10.35	6.65	1.70	11.60	16.60	12.35	14.25	16.00	16.00	0.404	0.259	0.066	0.452	0.647	0.482	0.556	0.624	0.624
C3039	POM	White	13.10	7.90	2.85	14.30	19.85	19.85	11.95	20.10	11.95	0.511	0.308	0.111	0.558	0.774	0.774	0.466	0.784	0.466
C3040	POM	Grey	13.30	9.40	2.20	11.90	16.10	12.00	9.80	19.75	14.05	0.519	0.367	0.086	0.464	0.628	0.468	0.382	0.770	0.548
C3049	POM	White	14.35	9.40	2.20	10.95	15.30	12.00	10.30	19.85	14.05	0.560	0.367	0.086	0.427	0.597	0.468	0.402	0.774	0.548
C3050	POM	White	14.30	9.00	2.30	10.00	14.50	12.00	10.00	18.00	14.15	0.558	0.351	0.090	0.390	0.566	0.468	0.390	0.702	0.552
C3052	POM	Grey	14.20	9.25	2.20	10.10	14.45	11.95	10.00	20.00	14.15	0.554	0.361	0.086	0.394	0.564	0.466	0.390	0.780	0.552
C3263	POM	White	11.70	9.65	2.20	12.25	17.70	11.90	13.90	13.10	16.00	0.456	0.376	0.086	0.478	0.690	0.464	0.542	0.511	0.624
C3338	POM	Natural	18.00	13.00	2.80	10.85	16.10	20.00	12.00	26.00	19.80	0.702	0.507	0.109	0.423	0.628	0.780	0.468	1.014	0.772
C3346	POM	Yellow	13.00	8.70	2.80	20.05	25.90	19.90	9.40	20.05	14.00	0.507	0.339	0.109	0.782	1.010	0.776	0.367	0.782	0.546

## — SIDE MOULDING CLIP

Part No.	Material	Color	mm									in								
			A	B	C	D	E	F	G	H	I	A	B	C	D	E	F	G	H	I
C3347	POM	White	12.00	7.90	2.80	10.64	16.15	12.00	19.95	15.00	15.00	0.468	0.308	0.109	0.415	0.630	0.468	0.778	0.585	0.585
C3417	POM	Natural	13.10	7.95	2.50	14.15	20.10	20.00	15.20	16.65	16.65	0.511	0.310	0.098	0.552	0.784	0.780	0.593	0.649	0.649
C3441	POM	Natural	12.50	8.00	2.70	16.10	21.80	25.85	9.90	19.95	15.75	0.488	0.312	0.105	0.628	0.850	1.008	0.386	0.778	0.614
C3445	POM	Natural	13.00	7.90	1.75	14.20	21.00	14.00	12.10	16.00	12.95	0.507	0.308	0.068	0.554	0.819	0.546	0.472	0.624	0.505
C3483	POM	Blue	10.80	7.75	1.70	12.55	18.55	10.80	14.05	19.80	17.70	0.421	0.302	0.066	0.489	0.723	0.421	0.548	0.772	0.690
C3497	POM	Natural	7.20	4.35	2.20	8.40	12.40	10.00	10.00	10.00	10.00	0.281	0.170	0.086	0.328	0.484	0.390	0.390	0.390	0.390
C3526	POM	Black	9.55	11.60	2.25	7.25	12.90	16.00	12.05	18.00	15.90	0.372	0.452	0.088	0.283	0.503	0.624	0.470	0.702	0.620
C3552	POM	Natural	22.40	19.10	3.30	9.95	17.20	19.90	13.95	26.85	26.85	0.874	0.745	0.129	0.388	0.671	0.776	0.544	1.047	1.047
C3553	POM	Natural+Black	10.80	7.65	3.20	11.48	18.23	12.85	12.85	15.75	15.75	0.421	0.298	0.125	0.448	0.711	0.501	0.501	0.614	0.614
C3618	POM	Green	7.20	5.80	1.70	15.50	19.70	7.00	7.00	10.00	10.00	0.281	0.226	0.066	0.605	0.768	0.273	0.273	0.390	0.390
C3648	POM	White	13.45	9.90	0.70	14.90	20.70	13.00	15.00	20.00	17.40	0.525	0.386	0.027	0.581	0.807	0.507	0.585	0.780	0.679
C3650	POM	White	12.80	9.70	3.00	14.70	21.70	15.90	17.80	19.70	17.80	0.499	0.378	0.117	0.573	0.846	0.620	0.694	0.768	0.694
C3653	POM	Natural	11.25	7.00	2.40	10.35	15.80	19.50	11.80	14.30	14.30	0.439	0.273	0.094	0.404	0.616	0.761	0.460	0.558	0.558
C3662	POM	Natural	10.45	11.05	2.60	15.75	21.95	14.10	11.05	15.20	11.95	0.408	0.431	0.101	0.614	0.856	0.550	0.431	0.593	0.466
C3702	POM	Blue	10.65	8.50	4.20	7.55	17.50	22.00	20.20	22.00	20.20	0.415	0.332	0.164	0.294	0.683	0.858	0.788	0.858	0.788
C3759	POM	Natural	10.20	7.50	1.00	13.20	16.45	20.00	13.00	20.80	/	0.398	0.293	0.039	0.515	0.642	0.780	0.507	0.811	/
C3761	POM	Yellow	13.50	7.85	2.15	18.15	28.30	13.80	19.80	13.80	19.80	0.527	0.306	0.084	0.708	1.104	0.538	0.772	0.538	0.772
C3768	POM	Natural	14.50	9.40	2.75	10.00	16.35	15.95	17.85	18.05	32.35	0.566	0.367	0.107	0.390	0.638	0.622	0.696	0.704	1.262
C3808	POM	Natural	10.40	11.60	2.20	6.90	12.90	12.00	16.00	18.00	16.00	0.406	0.452	0.086	0.269	0.503	0.468	0.624	0.702	0.624
C3834	POM	Natural	13.30	7.75	2.95	16.80	26.65	32.30	45.10	37.25	25.25	0.519	0.302	0.115	0.655	1.039	1.260	1.759	1.453	0.985
C3837	POM	Grey	13.10	8.05	2.45	15.60	20.45	7.50	11.05	15.10	15.10	0.511	0.314	0.096	0.608	0.798	0.293	0.431	0.589	0.589
C3851	PA	Black	11.90	8.35	2.40	14.62	18.45	15.10	18.30	20.20	/	0.464	0.326	0.094	0.570	0.720	0.589	0.714	0.788	/
C3933	POM	Natural	13.10	7.20	2.45	10.65	19.10	16.00	18.00	18.10	32.05	0.511	0.281	0.096	0.415	0.745	0.624	0.702	0.706	1.250
C3990	POM	Grey	13.30	9.30	2.15	9.55	14.75	10.25	11.90	15.90	24.75	0.519	0.363	0.084	0.372	0.575	0.400	0.464	0.620	0.965
C4011	POM	Natural	8.85	6.60	3.30	7.70	14.20	12.10	8.05	12.05	12.05	0.345	0.257	0.129	0.300	0.554	0.472	0.314	0.470	0.470

### Product No.: C1167

**Material:**

**POM**

**Color:**

**Blue**

**Position:**

**Front and rear bumper, rocker panel**



Product Details

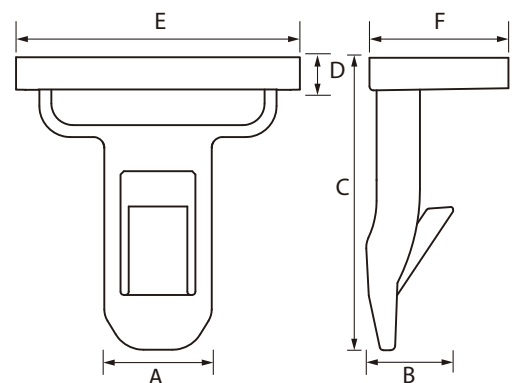

## SIDE MOULDING CLIP

Part No.	Material	Color	mm						in					
			A	B	C	D	E	F	A	B	C	D	E	F
C0212	POM	Black	16.55	9.45	43.30	12.50	46.20	25.10	0.645	0.369	1.689	0.488	1.802	0.979
C0345	PA	Black	15.70	10.00	17.65	1.60	20.00	11.00	0.612	0.390	0.688	0.062	0.780	0.429
C0348	PA	Black	17.20	13.80	26.30	4.50	31.20	13.90	0.671	0.538	1.026	0.176	1.217	0.542
C0547	POM	White	12.30	9.50	27.20	4.50	12.70	13.60	0.480	0.371	1.061	0.176	0.495	0.530
C1167	POM	Blue	10.00	6.80	26.80	7.30	25.85	12.70	0.390	0.265	1.045	0.285	1.008	0.495
C1270	PA	White	14.10	3.05	27.70	8.20	25.70	12.85	0.550	0.119	1.080	0.320	1.002	0.501
C1543	POM	White	8.30	4.55	24.70	5.70	12.90	12.45	0.324	0.177	0.963	0.222	0.503	0.486
C1670	POM	White	12.75	10.10	23.40	7.30	21.85	18.80	0.497	0.394	0.913	0.285	0.852	0.733
C1787	POM	Natural/ Black	10.00	8.30	17.25	7.10	21.00	11.30	0.390	0.324	0.673	0.277	0.819	0.441
C3094	POM	White	9.80	7.40	26.90	5.80	9.80	19.90	0.382	0.289	1.049	0.226	0.382	0.776
C3196	POM	Red	11.50	1.80	12.15	2.80	14.00	8.00	0.449	0.070	0.474	0.109	0.546	0.312

### Product No.: C0261

**Material:** PA  
**Color:** Black  
**Position:** Side moulding, rocker panel

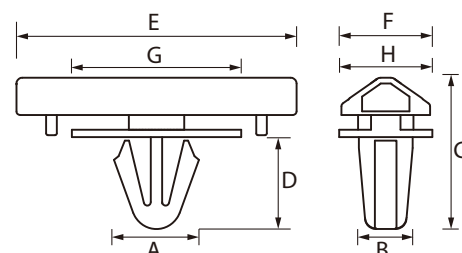

Product Details

Part No.	Material	Color	mm								in							
			A	B	C	D	E	F	G	H	A	B	C	D	E	F	G	H
C0078	PA	Black	11.35	8.00	22.40	14.00	51.00	14.60	15.40	15.40	0.443	0.312	0.874	0.546	1.989	0.569	0.601	0.601
C0191	PA	Black	11.45	8.50	18.80	11.60	30.40	24.30	19.20	19.20	0.447	0.332	0.733	0.452	1.186	0.948	0.749	0.749
C0224	POM	Black	10.75	6.00	16.85	14.20	32.70	12.15	6.70	4.70	0.419	0.234	0.657	0.554	1.275	0.474	0.261	0.183
C0261	PA	Black	11.20	7.35	20.65	12.55	38.00	11.90	23.10	12.40	0.437	0.287	0.805	0.489	1.482	0.464	0.901	0.484
C0688	PA	Black	11.45	8.05	21.95	13.85	38.80	13.05	15.20	15.20	0.447	0.314	0.856	0.540	1.513	0.509	0.593	0.593
C1484	POM	Grey/ Dark grey	12.80	8.00	22.30	14.85	38.00	16.00	38.00	16.00	0.499	0.312	0.870	0.579	1.482	0.624	1.482	0.624
C1512	PA	Black	11.80	6.20	17.00	14.50	33.30	17.20	11.70	5.00	0.460	0.242	0.663	0.566	1.299	0.671	0.456	0.195
C1625	POM	Black	13.60	8.05	22.40	14.80	38.40	13.75	38.40	16.10	0.530	0.314	0.874	0.577	1.498	0.536	1.498	0.628
C1682	PA	Black	13.20	8.10	23.70	14.80	20.70	50.75	16.25	16.25	0.515	0.316	0.924	0.577	0.807	1.979	0.634	0.634
C1972	POM	Black	12.05	8.00	22.10	14.75	13.80	39.75	18.00	14.00	0.470	0.312	0.862	0.575	0.538	1.550	0.702	0.546
C3763	PA	Black	12.20	7.90	17.70	11.10	50.00	14.85	18.00	14.85	0.476	0.308	0.690	0.433	1.950	0.579	0.702	0.579
C3895	POM	Black	33.00	7.85	25.92	13.95	40.10	10.00	40.10	10.00	1.287	0.306	1.011	0.544	1.564	0.390	1.564	0.390

## — SIDE MOULDING CLIP

**Product No.:** C0297

**Material:** POM  
**Color:** Red  
**Position:** Side moulding, rocker panel



Product Details

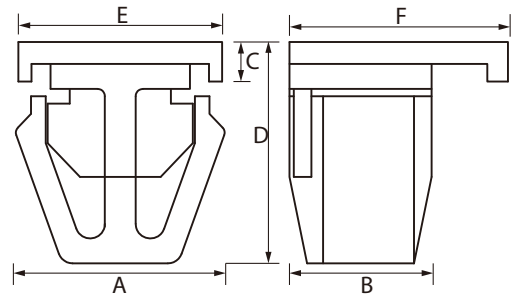

Part No.	Material	Color	mm						in					
			A	B	C	D	E	F	A	B	C	D	E	F
C0112	POM	Black	10.80	7.35	1.70	13.40	9.80	8.45	0.421	0.287	0.066	0.523	0.382	0.330
C0114	PA	Green	13.70	8.50	1.60	16.00	11.60	10.10	0.534	0.332	0.062	0.624	0.452	0.394
C0260	POM	White	13.00	9.50	1.55	14.75	13.65	14.30	0.507	0.371	0.060	0.575	0.532	0.558
C0295	POM	White	14.10	9.90	2.60	13.65	13.45	18.50	0.550	0.386	0.101	0.532	0.525	0.722
C0296	POM	Blue	14.35	9.75	1.70	17.00	14.70	12.00	0.560	0.380	0.066	0.663	0.573	0.468
C0297	POM	Red	13.90	9.75	3.30	15.20	14.90	13.85	0.542	0.380	0.129	0.593	0.581	0.540
C0902	PA	White	7.90	5.80	11.80	21.60	16.00	13.70	0.308	0.226	0.460	0.842	0.624	0.534
C0946	POM	White	15.00	12.50	17.00	25.30	32.00	19.00	0.585	0.488	0.663	0.987	1.248	0.741
C0948	POM	Yellow	8.30	5.95	8.10	15.70	15.60	12.30	0.324	0.232	0.316	0.612	0.608	0.480
C0953	POM	White	8.05	5.80	24.90	31.70	24.90	18.40	0.314	0.226	0.971	1.236	0.971	0.718
C0973	POM	White	10.80	7.40	10.90	13.60	28.50	9.90	0.421	0.289	0.425	0.530	1.112	0.386
C0979	POM	White	8.25	5.75	9.15	15.85	15.70	12.10	0.322	0.224	0.357	0.618	0.612	0.472
C0987	POM	White	13.10	9.70	1.50	12.30	15.10	15.10	0.511	0.378	0.059	0.480	0.589	0.589
C1149	POM	Black	12.75	9.00	3.00	13.50	21.80	7.90	0.497	0.351	0.117	0.527	0.850	0.308
C1966	POM	White	11.65	8.15	3.00	12.60	9.00	18.30	0.454	0.318	0.117	0.491	0.351	0.714
C3217	POM	Yellow	8.10	5.70	4.50	21.50	17.80	8.00	0.316	0.222	0.176	0.839	0.694	0.312
C3428	POM	Black	11.80	5.50	8.65	22.65	17.95	17.95	0.460	0.215	0.337	0.883	0.700	0.700
C3613	POM	Natural	8.90	6.50	5.70	17.00	23.95	13.85	0.347	0.254	0.222	0.663	0.934	0.540
C3659	POM	Natural	11.00	8.60	10.50	19.40	40.85	20.60	0.429	0.335	0.410	0.757	1.593	0.803

**Product No.:** C1319

**Material:** POM  
**Color:** Yellow  
**Position:** Side moulding

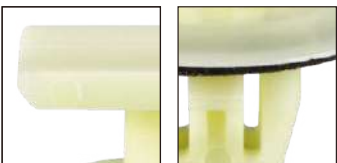

Product Details

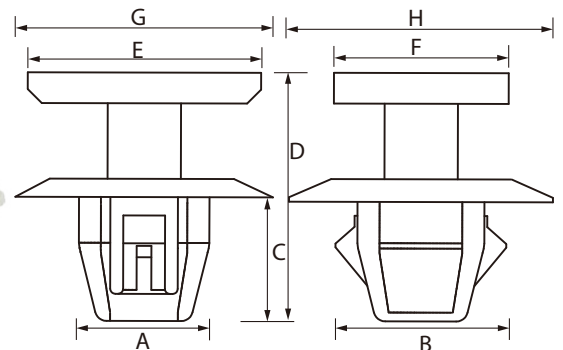



## SIDE MOULDING CLIP

Part No.	Material	Color	mm									in							
			A	B	C	D	E	F	G	H	A	B	C	D	E	F	G	H	
C0820	POM	White	7.70	8.70	11.70	19.00	21.60	14.35	25.80	21.30	0.300	0.339	0.456	0.741	0.842	0.560	1.006	0.831	
C1106	POM	White	10.15	10.60	9.90	15.60	13.00	/	19.00	/	0.396	0.413	0.386	0.608	0.507	/	0.741	/	
C1130	POM	White	5.40	9.00	9.30	15.50	13.40	6.00	12.40	13.55	0.211	0.351	0.363	0.605	0.523	0.234	0.484	0.528	
C1319	POM	Yellow	8.90	11.60	8.15	16.85	12.00	15.85	18.00	/	0.347	0.452	0.318	0.657	0.468	0.618	0.702	/	
C1320	POM	Grey	9.60	11.70	10.95	15.65	19.80	/	15.75	/	0.374	0.456	0.427	0.610	0.772	/	0.614	/	
C1353	POM	Blue	8.75	10.80	8.50	13.85	11.80	15.90	18.00	/	0.341	0.421	0.332	0.540	0.460	0.620	0.702	/	
C1528	POM	White	5.80	7.30	11.05	16.95	11.00	9.10	17.35	8.15	0.226	0.285	0.431	0.661	0.429	0.355	0.677	0.318	
C1614	POM	White	9.80	13.10	9.50	15.40	14.85	11.75	20.15	13.95	0.382	0.511	0.371	0.601	0.579	0.458	0.786	0.544	
C1664	POM	Green	11.90	11.00	10.40	20.70	12.85	/	19.90	/	0.464	0.429	0.406	0.807	0.501	/	0.776	/	
C1703	POM	White	11.65	10.80	10.45	14.80	12.00	6.00	16.00	/	0.454	0.421	0.408	0.577	0.468	0.234	0.624	/	
C1732	POM	White	9.65	12.75	7.40	13.70	15.85	11.85	21.90	20.00	0.376	0.497	0.289	0.534	0.618	0.462	0.854	0.780	
C1812	POM	White	7.60	10.75	11.85	20.00	15.00	/	18.05	/	0.296	0.419	0.462	0.780	0.585	/	0.704	/	
C1926	POM	White	7.80	12.75	9.20	15.25	15.00	11.90	30.20	14.00	0.304	0.497	0.359	0.595	0.585	0.464	1.178	0.546	
C1928	POM	White	9.80	12.60	10.00	11.60	11.70	9.60	21.00	15.80	0.382	0.491	0.390	0.452	0.456	0.374	0.819	0.616	
C1967	POM	White	5.70	8.30	10.60	15.90	16.90	/	15.00	/	0.222	0.324	0.413	0.620	0.659	/	0.585	/	
C3047	POM	White	8.55	13.30	9.70	11.25	13.00	13.00	/	/	0.333	0.519	0.378	0.439	0.507	0.507	/	/	
C3075	POM	White	9.80	10.50	10.10	19.15	13.00	12.95	19.30	/	0.382	0.410	0.394	0.747	0.507	0.505	0.753	/	
C3223	POM	Blue	5.90	8.30	9.95	15.15	9.60	14.90	18.80	/	0.230	0.324	0.388	0.591	0.374	0.581	0.733	/	
C3525	POM	Natural	11.50	11.90	12.40	19.50	16.75	13.00	21.70	18.60	0.449	0.464	0.484	0.761	0.653	0.507	0.846	0.725	
C3616	POM	Natural	11.00	11.33	12.14	24.15	14.60	/	22.00	13.00	0.429	0.442	0.473	0.942	0.569	/	0.858	0.507	
C3681	POM	Black	8.45	11.40	9.35	19.95	16.95	/	16.95	/	0.330	0.445	0.365	0.778	0.661	/	0.661	/	
C3772	POM	Natural	8.10	11.00	9.85	16.00	11.90	/	18.00	/	0.316	0.429	0.384	0.624	0.464	/	0.702	/	
C3773	POM	Light Orange	8.70	11.55	8.50	14.00	12.00	16.00	18.20	/	0.339	0.450	0.332	0.546	0.468	0.624	0.710	/	
C3791	POM	Natural	11.10	7.75	10.90	18.82	13.00	/	20.00	/	0.433	0.302	0.425	0.734	0.507	/	0.780	/	

### Product No.: C1263

**Material:** POM  
**Color:** Red  
**Position:** Side moulding, rocker panel

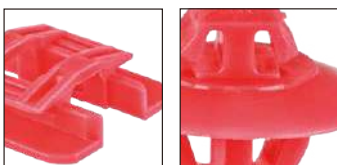

Product Details

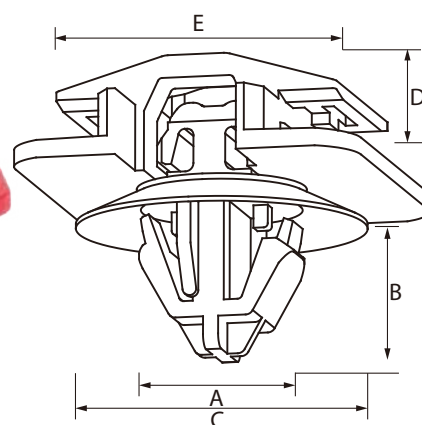

Part No.	Material	Color	mm					in				
			A	B	C	D	E	A	B	C	D	E
C1256	POM	White	8.9x5.9	7.70	18.00	6.60	21.8x27.8	0.347x0.230	0.300	0.702	0.257	0.850x1.084
C1258	POM	White + Blue	9.7x5.0	10.70	19.00	6.50	25.8x30.15	0.378x0.195	0.417	0.741	0.254	1.006x1.176
C1261	POM	White + Red	10.4x11.25	8.70	19.00	6.50	30.15x25.8	0.406x0.437	0.339	0.741	0.254	1.176x1.006
C1263	POM	Red	9.8x10.9	8.05	17.85	7.15	21.9x24.7	0.382x0.425	0.314	0.696	0.279	0.854x0.963

# SIDE MOULDING CLIP

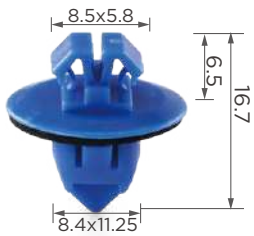

C0227

**Material:** POM  
**Color:** Blue  
**Side moulding, rear panel, rocker panel**

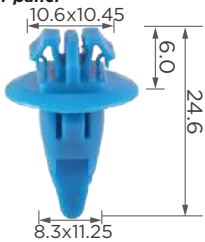

C0689

**Material:** POM  
**Color:** Blue  
**Fender flare**

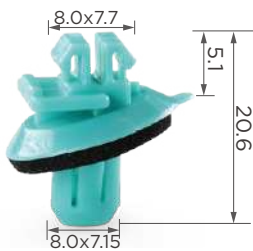

C0805

**Material:** POM  
**Color:** Green  
**Side moulding**

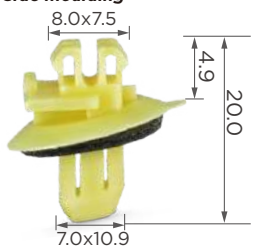

C1088

**Material:** POM  
**Color:** Yellow  
**Side moulding, fender flare, rocker panel**

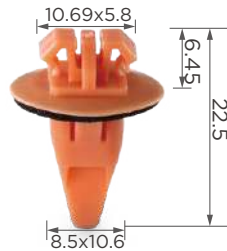

C0228

**Material:** POM  
**Color:** Orange  
**Side moulding, rear panel, rocker panel**

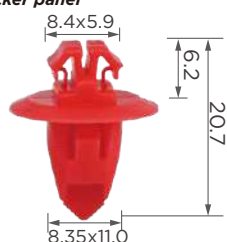

C0690

**Material:** POM  
**Color:** Red  
**Fender flare**

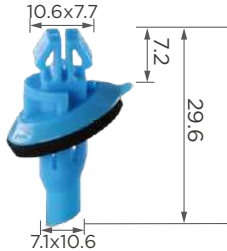

C0806

**Material:** POM  
**Color:** Blue  
**Side moulding**

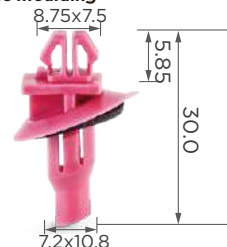

C1089

**Material:** POM  
**Color:** Dark pink  
**Side moulding, fender flare, rocker panel**

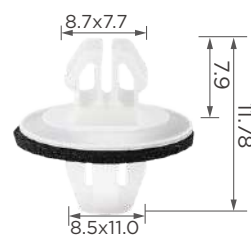

C0378

**Material:** POM  
**Color:** White  
**Rear bumper**

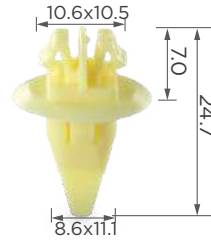

C0695

**Material:** POM  
**Color:** Yellow  
**Fender flare**



C0807

**Material:** POM  
**Color:** Grey  
**Rocker panel, fender flare**

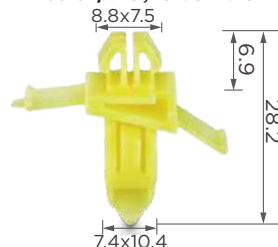

C1090

**Material:** POM  
**Color:** Yellow  
**Side moulding, fender flare, rocker panel**

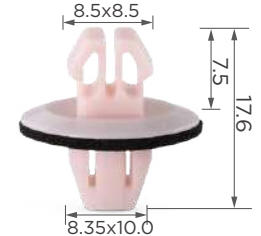

C0380

**Material:** POM  
**Color:** Pink  
**Rocker panel**

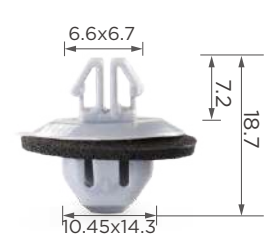

C0804

**Material:** POM  
**Color:** Grey  
**Side moulding**

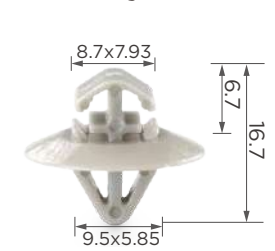

C0850

**Material:** POM  
**Color:** Grey  
**Rear spoiler, side moulding**

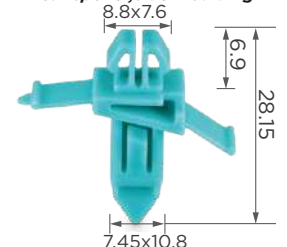

C1091

**Material:** POM  
**Color:** Green  
**Side moulding, fender flare, rocker panel**

## SIDE MOULDING CLIP

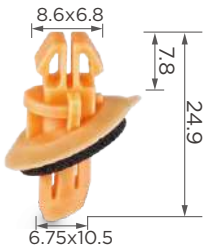

C1092

**Material:** POM  
**Color:** Orange  
**Side moulding, fender flare, rocker panel**



C1093

**Material:** POM  
**Color:** Black  
**Side moulding, fender flare, rocker panel**



C1438

**Material:** POM  
**Color:** White  
**Fender flare, splash guard**



C1824

**Material:** POM  
**Color:** White  
**Rocker panel, sill, side moulding**



C3016

**Material:** POM  
**Color:** Yellow  
**Side moulding, fender flare, rocker panel**



C3409

**Material:** POM  
**Color:** Natural  
**Side moulding**

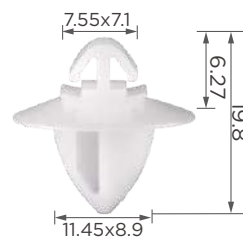

C3503

**Material:** POM  
**Color:** Natural  
**Side moulding**

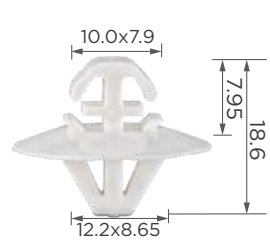

C3584

**Material:** PA  
**Color:** Milk white  
**Side moulding**



C0289

**Material:** POM  
**Color:** White  
**Rocker panel**

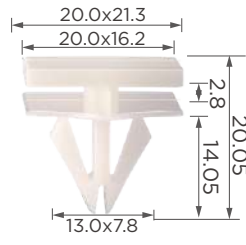

C0336

**Material:** POM  
**Color:** White  
**Rocker panel**



C0342

**Material:** POM  
**Color:** White  
**Rocker panel**

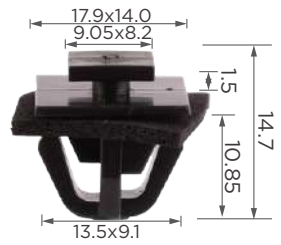

C0360

**Material:** POM  
**Color:** Black  
**Side moulding, rocker panel**

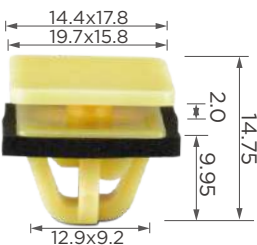

C0361

**Material:** POM  
**Color:** Yellow  
**Rocker panel**



C0388

**Material:** POM  
**Color:** Grey  
**Rocker panel**



C0673

**Material:** POM  
**Color:** Grey/ Natural  
**Rocker panel**

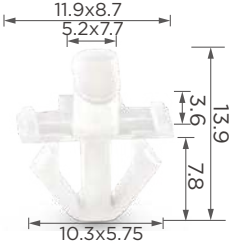

C0693

**Material:** POM  
**Color:** White  
**Rocker panel, sill**

## SIDE MOULDING CLIP

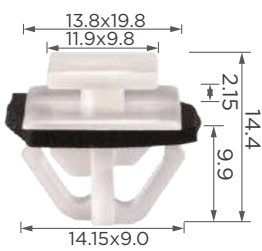

C0828

**Material:** POM  
**Color:** White  
**Side moulding, fender flare, rocker paneling**

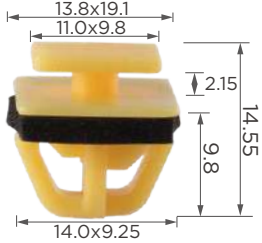

C0969

**Material:** POM  
**Color:** Yellow  
**Side moulding, fender flare, rocker panel**

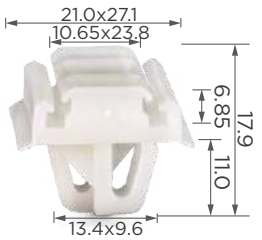

C1181

**Material:** POM  
**Color:** White  
**Side moulding, rocker panel**

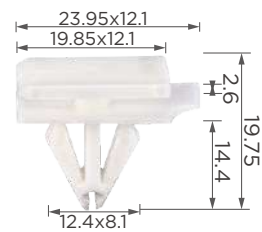

C1271

**Material:** POM  
**Color:** White/ Natural  
**Side moulding, rocker panel**

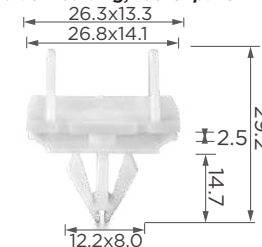

C1489

**Material:** POM  
**Color:** White  
**Side moulding, rocker panel**



C0857

**Material:** POM  
**Color:** White  
**Side moulding**

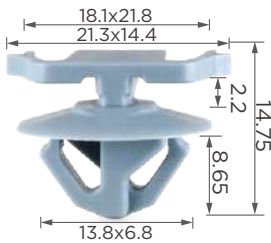

C0983

**Material:** POM  
**Color:** Light blue  
**Side moulding**

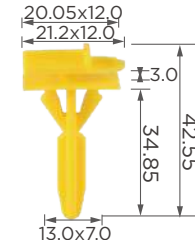

C1188

**Material:** POM  
**Color:** Yellow  
**Roof Spoiler, rear panel**

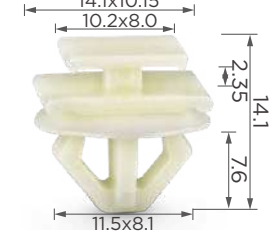

C1280

**Material:** POM  
**Color:** Beige  
**Grille, mirror**

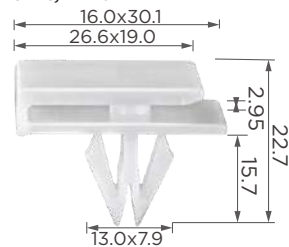

C1513

**Material:** POM  
**Color:** White  
**Side moulding, rocker panel**



C0889

**Material:** POM  
**Color:** White  
**Side moulding, fender flare, rocker panel**



C0988

**Material:** POM  
**Color:** White  
**Side moulding**



C1199

**Material:** POM  
**Color:** White  
**Side moulding, rocker panel**



C1315

**Material:** POM  
**Color:** Red  
**Side moulding, rocker panel**

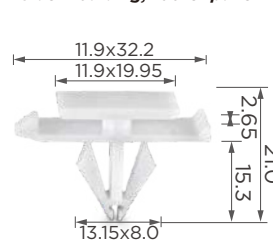

C1519

**Material:** POM  
**Color:** White  
**Side moulding, rocker panel**

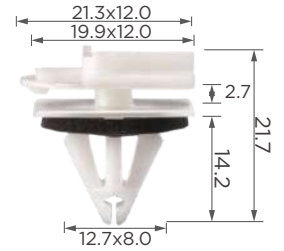

C0958

**Material:** POM  
**Color:** White  
**Roof Spoiler**

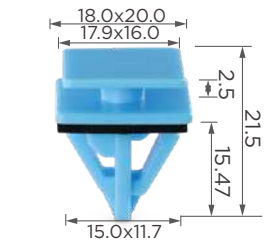

C1152

**Material:** POM  
**Color:** Blue  
**Rocker panel**



C1248

**Material:** POM  
**Color:** White  
**Side moulding**



C1325

**Material:** PA  
**Color:** White  
**Door panel**



C1523

**Material:** POM  
**Color:** White  
**Liftgate**

# SIDE MOULDING CLIP



**C1524**  
**Material:** POM  
**Color:** White  
*Side moulding, rocker panel*

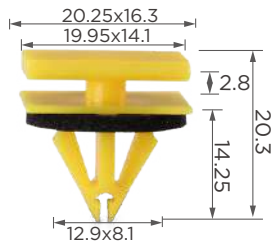

**C1540**  
**Material:** POM  
**Color:** Yellow/ Blue  
*Side moulding, rocker panel*

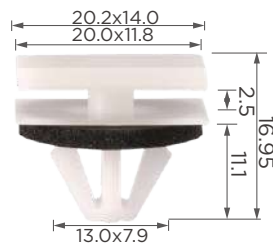

**C1541**  
**Material:** POM  
**Color:** White  
*Side moulding, rocker panel*

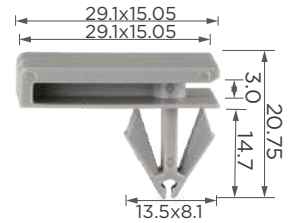

**C1603**  
**Material:** POM  
**Color:** Grey  
*Side moulding, rocker panel*



**C1604**  
**Material:** POM  
**Color:** White  
*Side moulding, rocker panel*



**C1605**  
**Material:** POM  
**Color:** Grey  
*Rear panel, spoiler, side moulding, rocker panel*

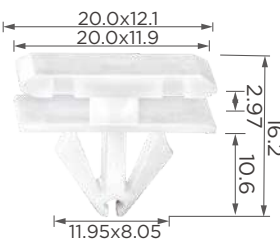

**C1606**  
**Material:** POM  
**Color:** Natural  
*Wheelarch, rear panel*

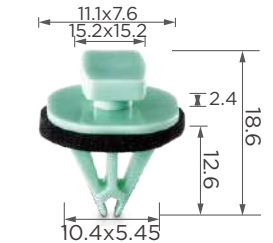

**C1607**  
**Material:** POM  
**Color:** Green  
*Wheelarch fender*



**C1615**  
**Material:** POM  
**Color:** White  
*Tailgate panel*

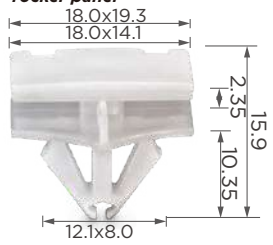

**C1624**  
**Material:** POM  
**Color:** White  
*Side moulding, rocker panel*



**C1626**  
**Material:** POM  
**Color:** White  
*Side moulding, rocker panel*



**C1627**  
**Material:** POM  
**Color:** Grey  
*Side moulding, rocker panel, fender flare, rear panel*



**C1637**  
**Material:** POM  
**Color:** White  
*Front bumper*



**C1658**  
**Material:** POM  
**Color:** White  
*Side moulding*

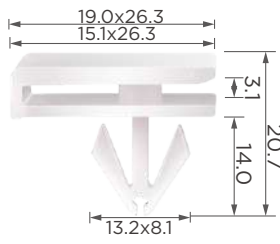

**C1680**  
**Material:** POM  
**Color:** White  
*Side moulding, rocker panel*



**C1685**  
**Material:** POM  
**Color:** White  
*Side moulding, rocker panel*



**C1697**  
**Material:** POM  
**Color:** White  
*Side moulding, rocker panel*

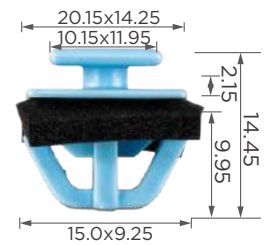

**C1698**  
**Material:** POM  
**Color:** Blue  
*Side moulding, rocker panel*



**C1716**  
**Material:** POM  
**Color:** White  
*Side moulding, rocker panel*

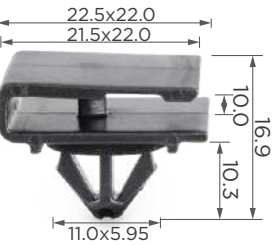

**C1724**  
**Material:** POM  
**Color:** Black  
*Side moulding, rocker panel*



## SIDE MOULDING CLIP

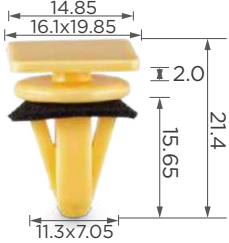

C1727

**Material:** POM**Color:** Natural**Side moulding, rocker panel**

C1828

**Material:** POM**Color:** Yellow**Side moulding, rocker panel**

C1923

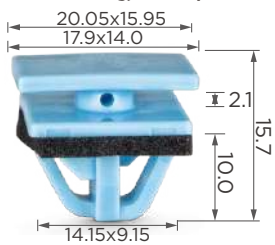
**Material:** POM**Color:** White**Side moulding, rocker panel**

C1961

**Material:** POM**Color:** Blue**Rocker panel**

C3039

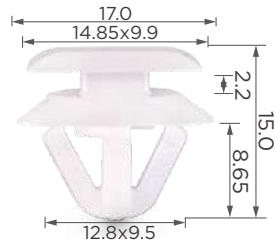
**Material:** POM**Color:** White**Side moulding, rocker panel**

C1758

**Material:** POM**Color:** Natural**Side moulding, rocker panel, wheelarch**

C1832

**Material:** POM**Color:** White**Side moulding, rocker panel**

C1947

**Material:** POM**Color:** White**Rocker panel**

C1970

**Material:** POM**Color:** White**Side moulding**

C3013

**Material:** PA**Color:** Black+light green**Fender**

C1792

**Material:** POM**Color:** White**Rear panel**

C1901

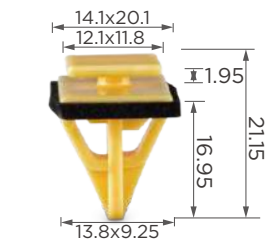
**Material:** POM**Color:** White**Side moulding, rocker panel**

C1956

**Material:** POM**Color:** White**Rocker panel**

C1985

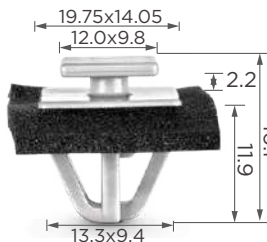
**Material:** POM**Color:** Grey**Rocker panel**

C3040

**Material:** POM**Color:** Grey**Rear panel**

C1793

**Material:** POM**Color:** Black**Front bumper**

C1902

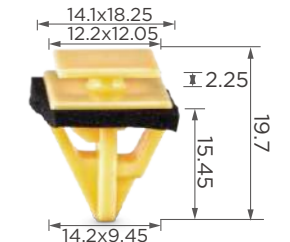
**Material:** PA + POM**Color:** White**Side moulding, rocker panel**

C1957

**Material:** POM**Color:** Yellow**Rocker panel**

C3037

**Material:** PA**Color:** White**Side moulding, rear panel**

C3049

**Material:** POM**Color:** White**Side moulding, rocker panel**



# SIDE MOULDING CLIP

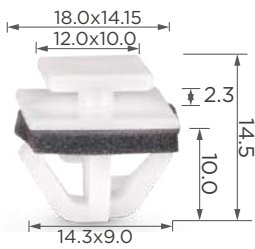

**C3050**

**Material:** POM  
**Color:** White  
**Side moulding**

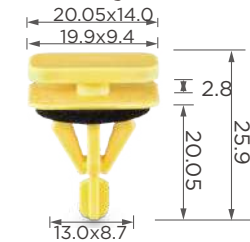

**C3346**

**Material:** POM  
**Color:** Yellow  
**Side moulding, rocker panel, spoiler, wheelarch**



**C3445**

**Material:** POM  
**Color:** Natural  
**Rear panel**



**C3552**

**Material:** POM  
**Color:** Natural  
**Side moulding, rocker panel**



**C3650**

**Material:** POM  
**Color:** White  
**Rocker Panel, Side Moulding**

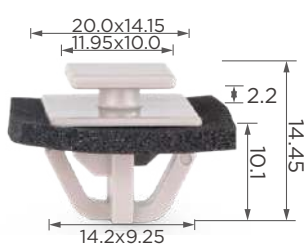

**C3052**

**Material:** POM  
**Color:** Grey  
**Rocker panel**



**C3347**

**Material:** POM  
**Color:** White  
**Side moulding, rocker panel**



**C3483**

**Material:** TPE+POM  
**Color:** Light blue  
**Side moulding**



**C3553**

**Material:** POM  
**Color:** Natural+ Black  
**Side moulding**



**C3653**

**Material:** POM  
**Color:** Natural  
**Front wheel arch**



**C3263**

**Material:** POM  
**Color:** White  
**Side moulding, rocker panel**



**C3417**

**Material:** POM  
**Color:** Natural  
**Side moulding, rocker panel**



**C3497**

**Material:** POM  
**Color:** Natural  
**Door panel**

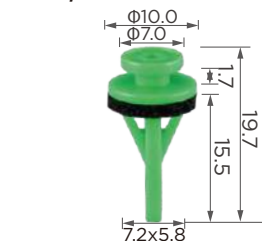

**C3618**

**Material:** POM  
**Color:** Green  
**Side moulding, pillar**



**C3662**

**Material:** POM  
**Color:** Natural  
**Rocker panel**



**C3338**

**Material:** POM  
**Color:** Natural  
**Side moulding, rocker panel**

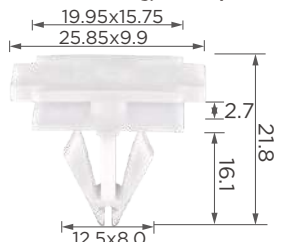

**C3441**

**Material:** POM  
**Color:** Natural  
**Side moulding, rocker panel**



**C3526**

**Material:** POM  
**Color:** Black  
**Side moulding, fender flare**

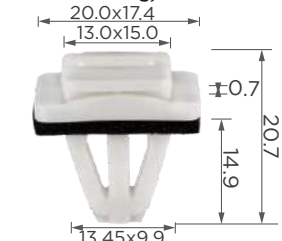

**C3648**

**Material:** POM  
**Color:** White  
**Rocker Panel, Bumper**

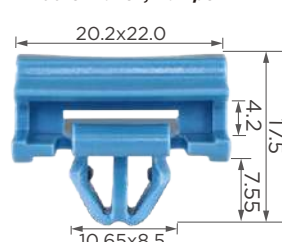

**C3702**

**Material:** POM  
**Color:** Blue  
**Rocker panel**

## — SIDE MOULDING CLIP

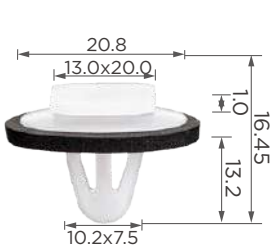

C3759

**Material:** POM  
**Color:** Natural  
**Body trim**

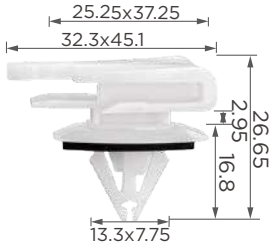

C3834

**Material:** POM  
**Color:** Natural  
**Rocker panel**

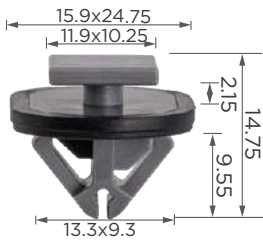

C3990

**Material:** POM  
**Color:** Grey  
**Fender liner, rocker panel**

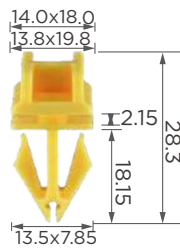

C3761

**Material:** POM  
**Color:** Yellow  
**Fender flare**



C3837

**Material:** POM  
**Color:** Grey  
**Trunk lid center applique, rocker panel, side modling**



C4011

**Material:** POM  
**Color:** Natural  
**Hinge cover**



C3768

**Material:** POM  
**Color:** Natural  
**Rocker panel**

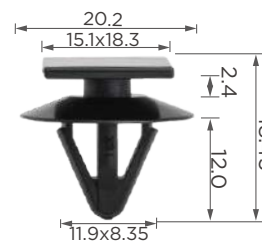

C3851

**Material:** PA  
**Color:** Black  
**Grille, side molding, rocker panel**



C3808

**Material:** POM  
**Color:** Natural  
**Side molding**



C3933

**Material:** POM  
**Color:** Natural  
**Rocker panel, side skirt cover**



C0212

**Material:** POM  
**Color:** Black  
**Side moulding**



C0345

**Material:** POM  
**Color:** Black  
**Rocker panel**



C0348

**Material:** POM  
**Color:** Black  
**Side moulding, rocker panel, fender flare**



C0547

**Material:** POM  
**Color:** White  
**Door panel**

## SIDE MOULDING CLIP

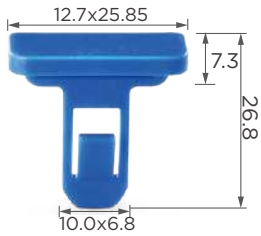

C1167

**Material:** POM  
**Color:** Blue  
**Front and rear bumper, rocker panel**



C1270

**Material:** POM  
**Color:** White  
**Front bumper, rocker panel**



C1543

**Material:** POM  
**Color:** White  
**Rear bumper**



C1670

**Material:** POM  
**Color:** White  
**Front and rear bumper**



C1787

**Material:** POM  
**Color:** White/ Black  
**Front and rear bumper**



C3094

**Material:** POM  
**Color:** White  
**Rear bumper**

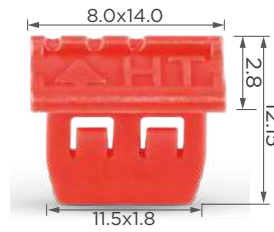

C3196

**Material:** POM  
**Color:** Red  
**Door panel**

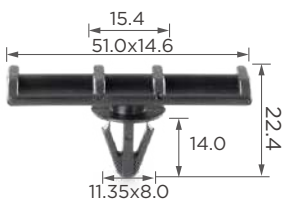

CO078

**Material:** PA  
**Color:** Black  
**Side moulding**

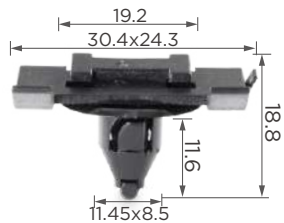

CO191

**Material:** PA  
**Color:** Black  
**Side moulding**



CO224

**Material:** POM  
**Color:** Black  
**Side moulding, rocker panel**



CO261

**Material:** PA  
**Color:** Black  
**Side moulding, rocker panel**

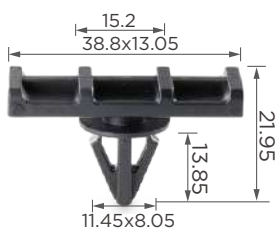

CO688

**Material:** PA  
**Color:** Black  
**Side moulding, rocker panel**

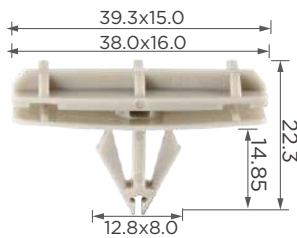

C1484

**Material:** POM  
**Color:** Grey/ Dark grey  
**Side moulding, rocker panel**



C1512

**Material:** PA  
**Color:** Black  
**Side moulding**

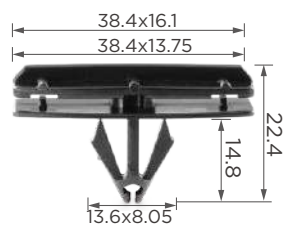

C1625

**Material:** POM  
**Color:** Black  
**Side moulding, fender flare**

## — SIDE MOULDING CLIP

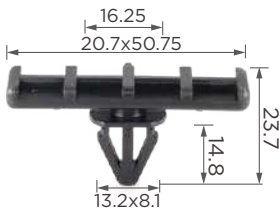

C1682

**Material:** PA  
**Color:** Black  
**Side moulding**



C1972

**Material:** POM  
**Color:** Black  
**Side moulding, rocker panel**

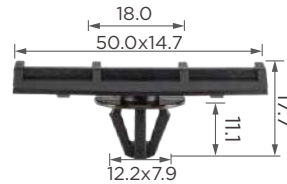

C3763

**Material:** PA  
**Color:** Black  
**Fender flare**

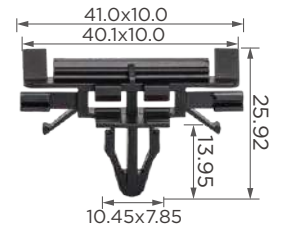

C3895

**Material:** POM  
**Color:** Black  
**Windshield, door side moulding**

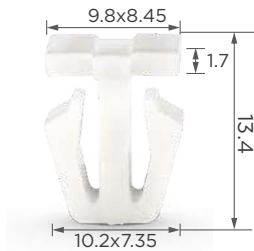

C0112

**Material:** POM  
**Color:** White  
**Side moulding**

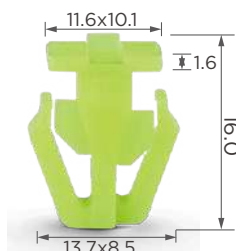

C0114

**Material:** PA  
**Color:** Green  
**Side moulding, rocker panel**



C0260

**Material:** POM  
**Color:** White  
**Side moulding, rocker panel**

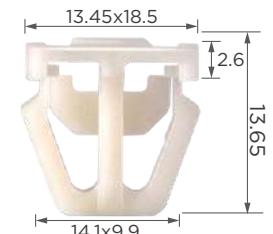

C0295

**Material:** POM  
**Color:** White  
**Side moulding, rocker panel**



C0296

**Material:** POM  
**Color:** Blue  
**Side moulding, rocker panel**

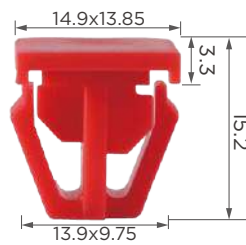

C0297

**Material:** POM  
**Color:** Red  
**Side moulding, rocker panel**

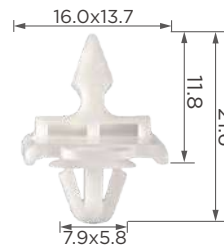

C0902

**Material:** PA  
**Color:** White  
**Side moulding**



C0946

**Material:** POM  
**Color:** White  
**Side moulding**

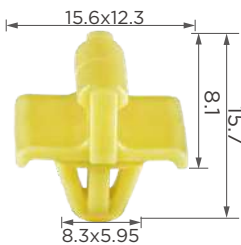

C0948

**Material:** POM  
**Color:** Yellow  
**Side moulding**

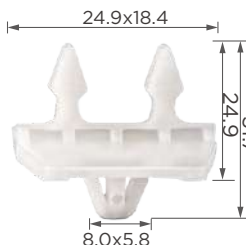

C0953

**Material:** POM  
**Color:** White  
**Side moulding**



C0973

**Material:** POM  
**Color:** White  
**Side moulding**



C0979

**Material:** POM  
**Color:** White  
**Side moulding**

## SIDE MOULDING CLIP



C0987

**Material:** POM  
**Color:** White  
**Side moulding**

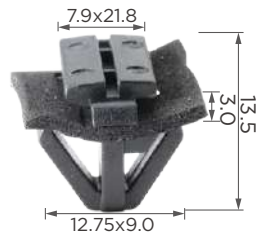

C1149

**Material:** POM  
**Color:** Black  
**Rocker panel, sill, side moulding**



C1966

**Material:** POM  
**Color:** White  
**Side moulding**

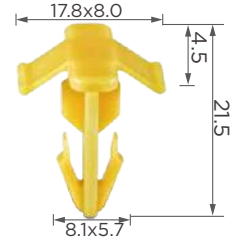

C3217

**Material:** POM  
**Color:** Yellow  
**Door panel**



C3428

**Material:** POM  
**Color:** Black  
**Front wheelarch, fuel tube**



C3613

**Material:** POM  
**Color:** Natural  
**Side moulding**



C3659

**Material:** POM  
**Color:** Natural  
**Rocker panel**

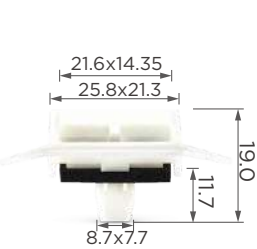

C0820

**Material:** POM  
**Color:** White  
**Cowl**



C1106

**Material:** POM  
**Color:** White  
**Tail light**



C1130

**Material:** POM  
**Color:** White  
**Door lock cylinder**



C1319

**Material:** POM  
**Color:** Yellow  
**Side moulding**



C1320

**Material:** POM  
**Color:** Grey  
**Side moulding**



C1353

**Material:** POM  
**Color:** Blue  
**Side moulding**



C1528

**Material:** POM  
**Color:** White  
**Rear fender**



C1614

**Material:** POM  
**Color:** White  
**Side moulding, rocker panel**

## SIDE MOULDING CLIP



C1664

**Material:** POM  
**Color:** Green  
**Tail light**



C1703

**Material:** POM  
**Color:** White  
**Fender flare, splash guard**



C1732

**Material:** POM  
**Color:** White  
**Side moulding, rocker panel**



C1812

**Material:** POM  
**Color:** White  
**Tail light**



C1926

**Material:** POM  
**Color:** White  
**Side moulding, rocker panel**



C1928

**Material:** POM  
**Color:** White  
**Side moulding, rocker panel**



C1967

**Material:** POM  
**Color:** White  
**Tail light**



C3074

**Material:** POM  
**Color:** White  
**Tail light**



C3075

**Material:** POM  
**Color:** White  
**Tail light**



C3223

**Material:** POM  
**Color:** Blue  
**Liftgate**

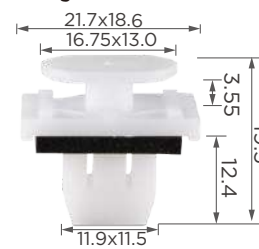

C3525

**Material:** POM  
**Color:** Natural  
**Rear bumper**



C3616

**Material:** POM  
**Color:** Natural  
**Footbrake**



C3681

**Material:** POM  
**Color:** Black  
**Tail lamp, rear panel**

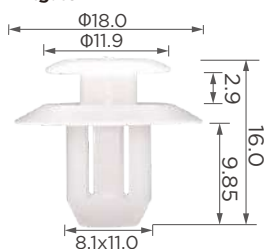

C3772

**Material:** POM  
**Color:** Natural  
**Rocker panel**

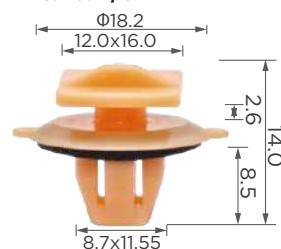

C3773

**Material:** POM  
**Color:** Light Orange  
**Rocker panel**



C3791

**Material:** POM  
**Color:** Natural  
**Taillight**



# SIDE MOULDING CLIP

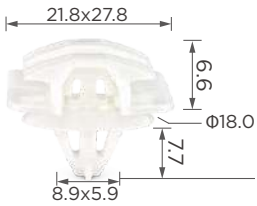

C1256

**Material:** POM  
**Color:** White  
*Side moulding, rocker panel*



C1256-A

**Material:** POM  
**Color:** White  
*Side moulding, rocker panel*

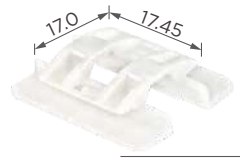

C1256-B

**Material:** POM  
**Color:** White  
*Side moulding, rocker panel*

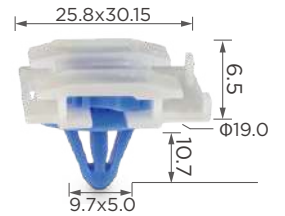

C1258

**Material:** POM  
**Color:** White + Blue  
*Side moulding, rocker panel*

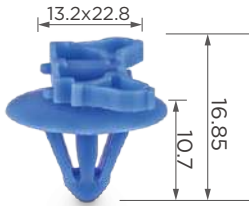

C1258-A

**Material:** POM  
**Color:** Blue  
*Side moulding, rocker panel*

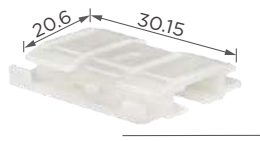

C1258-B

**Material:** POM  
**Color:** White  
*Side moulding, rocker panel*

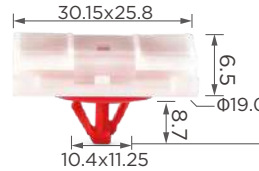

C1261

**Material:** POM  
**Color:** White + Red  
*Side moulding, rocker panel*

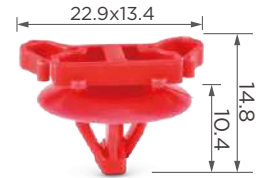

C1261-A

**Material:** POM  
**Color:** Red  
*Side moulding, rocker panel*



C1261-B

**Material:** POM  
**Color:** White  
*Side moulding, rocker panel*

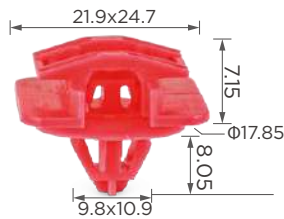

C1263

**Material:** POM  
**Color:** Red  
*Side moulding, rocker panel*

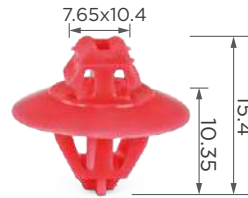

C1263-A

**Material:** POM  
**Color:** Red  
*Side moulding, rocker panel*

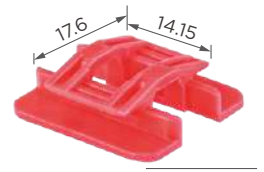

C1263-B

**Material:** POM  
**Color:** Red  
*Side moulding, rocker panel*

## EXTERIOR DOOR SIDE MOULDING CLIP

**Product No.:** C0904

**Material:** POM  
**Color:** White/ Yellow  
**Position:** Door side moulding

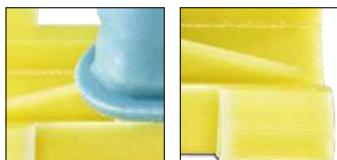

Product Details

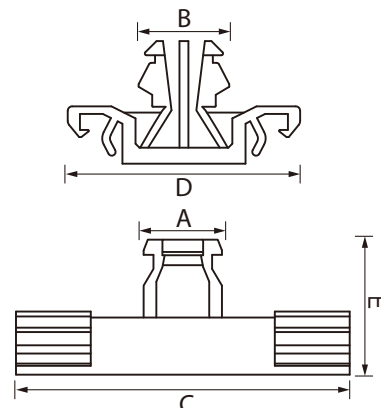

Part No.	Material	Color	mm					in				
			A	B	C	D	E	A	B	C	D	E
C0847	POM	White	8.00	10.30	38.20	34.00	14.90	0.312	0.402	1.490	1.326	0.581
C0848	POM	White	5.25	11.00	22.40	35.20	12.95	0.205	0.429	0.874	1.373	0.505
C0901	POM	White	10.00	12.00	32.30	47.70	14.85	0.390	0.468	1.260	1.860	0.579
C0904	POM	White/ Yellow	8.00	9.40	25.60	34.00	13.80	0.312	0.367	0.998	1.326	0.538
C0909	POM	White	8.85	10.75	18.60	40.30	14.95	0.345	0.419	0.725	1.572	0.583
C0910	POM	White	10.50	8.25	35.00	38.30	15.00	0.410	0.322	1.365	1.494	0.585
C0911	POM	White	8.85	10.60	17.65	21.00	13.20	0.345	0.413	0.688	0.819	0.515
C0912	POM	White	7.80	11.30	15.80	17.40	14.50	0.304	0.441	0.616	0.679	0.566
C0913	POM	White	6.70	11.00	21.90	34.70	10.40	0.261	0.429	0.854	1.353	0.406
C0916	POM	White	8.85	10.55	26.70	24.90	20.80	0.345	0.411	1.041	0.971	0.811
C0922	POM	White	8.20	10.75	38.65	34.35	21.50	0.320	0.419	1.507	1.340	0.839
C0928	POM	White	9.80	11.00	22.00	35.00	16.30	0.382	0.429	0.858	1.365	0.636
C0936	POM	White	8.30	10.70	17.80	31.05	15.50	0.324	0.417	0.694	1.211	0.605
C1483	POM	Original	8.20	10.50	20.45	35.00	13.00	0.320	0.410	0.798	1.365	0.507
C1638	POM	Original	10.00	13.45	22.80	39.30	26.50	0.390	0.525	0.889	1.533	1.034
C1654	POM	White	9.95	12.90	37.00	39.20	31.15	0.388	0.503	1.443	1.529	1.215
C3022	POM	Black	7.45	9.30	29.85	19.95	15.60	0.291	0.363	1.164	0.778	0.608

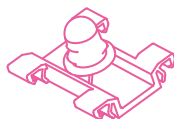

# EXTERIOR DOOR SIDE MOULDING CLIP

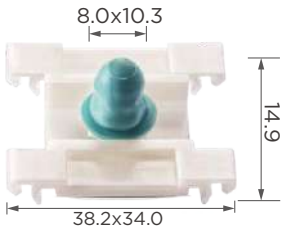

**C0847**

**Material:** POM  
**Color:** White  
**Door side moulding**



**C0848**

**Material:** POM  
**Color:** White  
**Door side moulding**



**C0901**

**Material:** POM  
**Color:** White  
**Door side moulding**



**C0904**

**Material:** POM  
**Color:** White/ Yellow  
**Door side moulding**



**C0909**

**Material:** POM  
**Color:** White  
**Door side moulding**

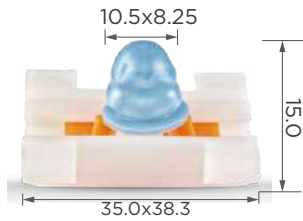

**C0910**

**Material:** POM  
**Color:** White  
**Door side moulding**



**C0911**

**Material:** Nylon  
**Color:** White  
**Door side moulding**



**C0912**

**Material:** POM  
**Color:** White  
**Door side moulding**



**C0913**

**Material:** POM  
**Color:** White  
**Door side moulding**



**C0916**

**Material:** POM  
**Color:** White  
**Door side moulding**



**C0922**

**Material:** POM  
**Color:** White  
**Door side moulding**

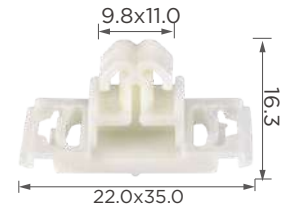

**C0928**

**Material:** POM  
**Color:** White  
**Door side moulding**



**C0936**

**Material:** POM  
**Color:** White  
**Door side moulding**

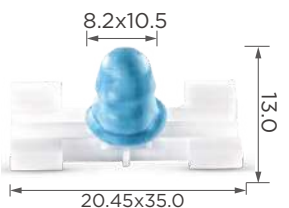

**C1483**

**Material:** POM  
**Color:** Natural  
**Door side moulding**



**C1638**

**Material:** POM  
**Color:** Natural  
**Door side moulding**



**C1654**

**Material:** POM  
**Color:** White  
**Door side moulding**



**C3022**

**Material:** POM  
**Color:** Black  
**Door sill**

# EXTERIOR DOOR SIDE MOULDING CLIP

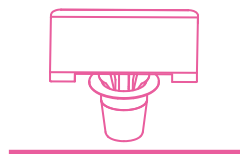

C0914

**Material:** POM  
**Color:** White  
**Door side moulding**



C0919

**Material:** POM  
**Color:** White  
**Door side moulding**

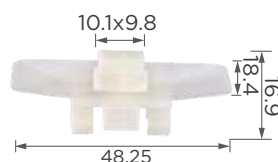

C0932

**Material:** POM  
**Color:** White  
**Door side moulding**



C1305

**Material:** POM  
**Color:** Natural  
**Door side moulding**

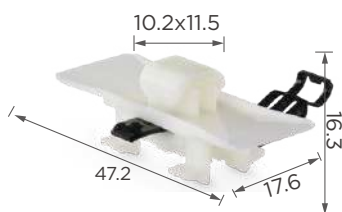

C1355

**Material:** POM+Metal  
**Color:** White+Black  
**Door side moulding**



C1442

**Material:** POM  
**Color:** Natural  
**Door side moulding**



C1443

**Material:** POM  
**Color:** Natural  
**Door side moulding**

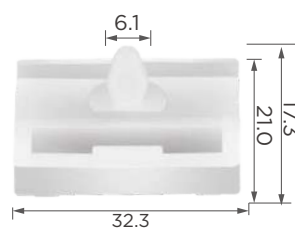

C1482

**Material:** POM  
**Color:** White  
**Door sill**



C1538

**Material:** POM  
**Color:** Natural  
**Door sill**



C1572

**Material:** POM  
**Color:** White  
**Door side moulding**

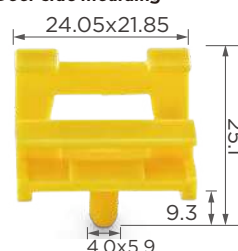

C1634

**Material:** POM  
**Color:** Yellow  
**Door sill**

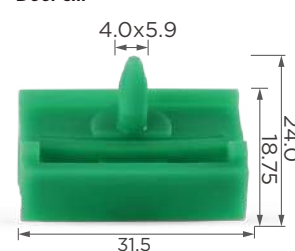

C1635

**Material:** POM  
**Color:** Green  
**Door sill**

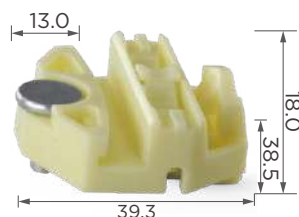

C1636

**Material:** POM  
**Color:** Light yellow  
**Door side moulding**



C1863

**Material:** POM  
**Color:** Natural  
**Door side moulding**



C1871

**Material:** POM  
**Color:** White+Black  
**Door side moulding**



C1881

**Material:** POM  
**Color:** Natural  
**Door sill**

# EXTERIOR DOOR SIDE MOULDING CLIP

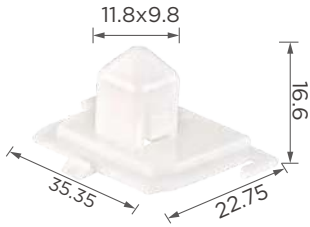

**C3082**

**Material:** POM  
**Color:** White  
**Door side moulding**

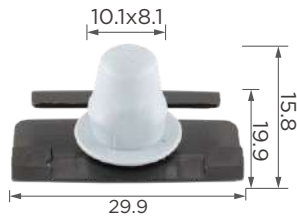

**C3365**

**Material:** POM  
**Color:** Black  
**Door side moulding**

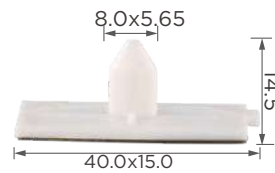

**C3471**

**Material:** POM  
**Color:** Natural  
**Door side moulding**



**C3550**

**Material:** POM  
**Color:** Natural  
**Door sill**

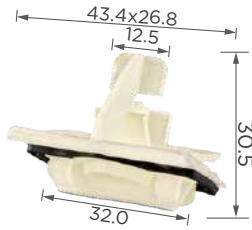

**C3385**

**Material:** PP  
**Color:** Natural  
**Side moulding**

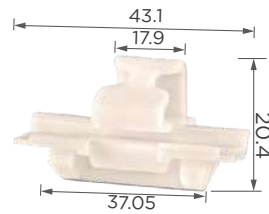

**C3386**

**Material:** POM  
**Color:** Natural  
**Side moulding, rocker panel**

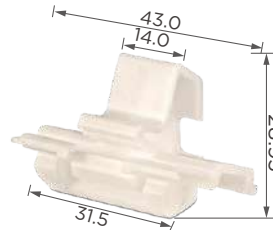

**C3392**

**Material:** POM  
**Color:** Natural  
**Side moulding, rocker panel**

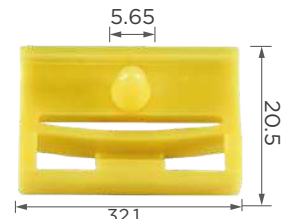

**C3625**

**Material:** POM  
**Color:** Yellow  
**Rocker panel**

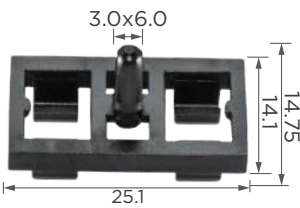

**C3660**

**Material:** POM  
**Color:** Black  
**Door seal**



**C3639**

**Material:** POM  
**Color:** Natural  
**Rocker panel**

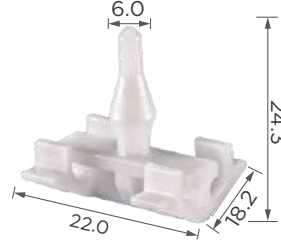

**C3665**

**Material:** POM  
**Color:** Natural  
**Rocker panel**

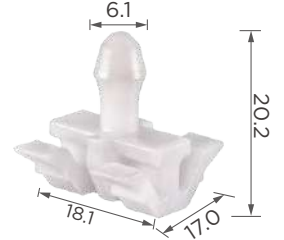

**C3672**

**Material:** POM  
**Color:** Natural  
**Rocker panel**



**C3972**

**Material:** POM+Metal  
**Color:** Black  
**Windshield**

## — INTERIOR TRIM CLIP

**Product No.:** C1291

**Material:** PA  
**Color:** Black  
**Position:** Seat

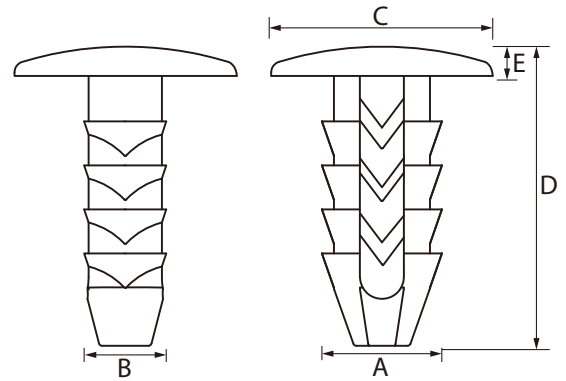

Part No.	Material	Color	mm					in				
			A	B	C	D	E	A	B	C	D	E
C3488	PA	Black	6.65	4.70	15.20	16.45	2.50	0.259	0.183	0.593	0.642	0.098
C3310	PA	Black	7.95	5.90	15.00	14.80	2.00	0.310	0.230	0.585	0.577	0.078
C1291	PA	Black	8.00	4.70	15.00	20.40	2.05	0.312	0.183	0.585	0.796	0.080
C1890	PA	Black	8.00	5.80	24.85	19.30	2.20	0.312	0.226	0.969	0.753	0.086
C1275	PA	Black	8.10	5.50	25.15	20.65	2.30	0.316	0.215	0.981	0.805	0.090
C1288	PA	Black	8.15	5.85	19.70	24.80	2.00	0.318	0.228	0.768	0.967	0.078
C3482	PA	Grey	8.75	7.90	13.80	25.10	1.70	0.341	0.308	0.538	0.979	0.066
C0213	PA	Black	9.20	5.70	16.05	20.00	2.00	0.359	0.222	0.626	0.780	0.078
C0853	PA	Black	9.40	8.55	24.30	19.20	2.10	0.367	0.333	0.948	0.749	0.082
C0855	PA	Grey	9.50	6.80	18.20	24.50	2.00	0.371	0.265	0.710	0.956	0.078
C1284	PA	Black	9.50	7.30	20.00	20.35	3.10	0.371	0.285	0.780	0.794	0.121
C1297	PA	Black	11.90	6.70	11.70	23.25	1.85	0.464	0.261	0.456	0.907	0.072

**Product No.:** C0985

**Material:** PA  
**Color:** Black  
**Position:** Rear tray, trunk lid

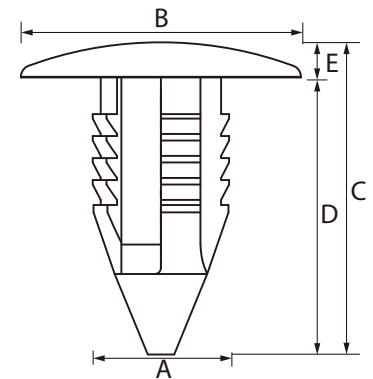



# INTERIOR TRIM CLIP

Part No.	Material	Color	mm					in				
			A	B	C	D	E	A	B	C	D	E
C0985	PA	Black	9.15	19.10	21.30	19.00	2.30	0.357	0.745	0.831	0.741	0.090
C1254	POM	Black	9.20	17.80	17.65	15.25	2.40	0.359	0.694	0.688	0.595	0.094
C1257	POM	Black	9.35	21.80	21.20	18.70	2.50	0.365	0.850	0.827	0.729	0.098
C1260	POM	Black	11.20	22.00	21.30	19.00	2.30	0.437	0.858	0.831	0.741	0.090
C1584	PA	Black	9.20	25.00	14.80	12.50	2.30	0.359	0.975	0.577	0.488	0.090



C0213

**Material:** PA  
**Color:** Black  
**Door cladding**



C0853

**Material:** PA  
**Color:** Black  
**Front head**

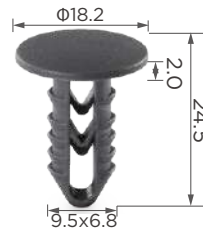

C0855

**Material:** PA  
**Color:** Grey  
**Body cover**

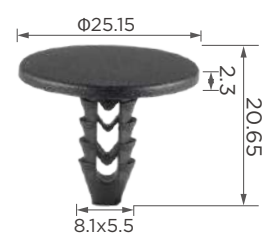

C1275

**Material:** PA  
**Color:** Black  
**Trim clip**



C1284

**Material:** PA  
**Color:** Black  
**Trim clip**



C1288

**Material:** PA  
**Color:** Black  
**Trim clip**



C1291

**Material:** PA  
**Color:** Black  
**Seat**



C1297

**Material:** PA  
**Color:** Black  
**Body cover**



C1890

**Material:** PA  
**Color:** Black  
**Roof**



C3310

**Material:** PA  
**Color:** Black  
**Instrument & side panel clip**

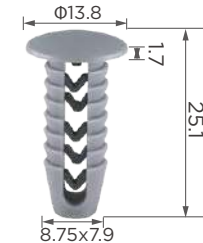

C3482

**Material:** PA  
**Color:** Grey  
**Trim clip**



C3488

**Material:** PA  
**Color:** Black  
**Front head**

# — INTERIOR TRIM CLIP



**C0985**

**Material:** PA  
**Color:** Black  
*Rear tray, trunk lid*



**C1254**

**Material:** POM  
**Color:** Black  
*Trim clip*



**C1257**

**Material:** POM  
**Color:** Black  
*Trim clip*

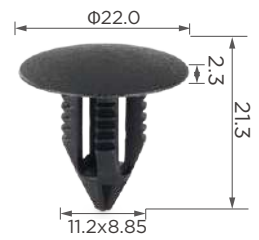

**C1260**

**Material:** POM  
**Color:** Black  
*Trim clip*



**C1584**

**Material:** PA  
**Color:** Black  
*Retainer*

# INSTRUMENT & SIDE PANEL CLIP

**Product No.:** C1191

**Material:** POM  
**Color:** Orange  
**Position:** Instrument & side panel clip

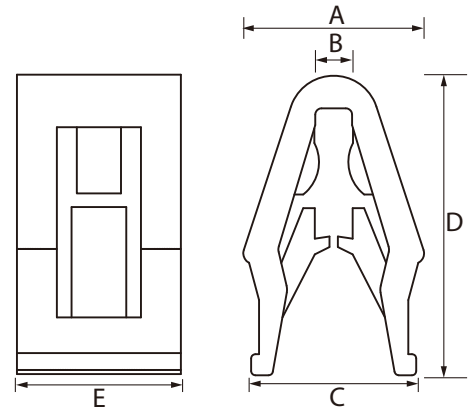

Part No.	Material	Color	mm					in				
			A	B	C	D	E	A	B	C	D	E
C0887	POM	White/ Beige	10.00	2.00	11.90	18.60	7.40	0.390	0.078	0.464	0.725	0.289
C0993	POM	Natural	7.40	2.20	14.60	12.55	7.20	0.289	0.086	0.569	0.489	0.281
C1143	POM	White	15.30	3.00	11.20	14.15	7.50	0.597	0.117	0.437	0.552	0.293
C1191	POM	Orange	8.10	1.60	7.40	14.15	7.80	0.316	0.062	0.289	0.552	0.304
C1311	PA	White	10.75	3.00	13.20	18.35	7.40	0.419	0.117	0.515	0.716	0.289
C1567	PA	Orange	9.30	2.30	14.15	15.00	8.50	0.363	0.090	0.552	0.585	0.332
C1710	POM	Yellow	10.00	2.30	13.90	17.35	8.00	0.390	0.090	0.542	0.677	0.312
C1778	POM	Natural	9.00	1.50	10.40	16.60	8.00	0.351	0.059	0.406	0.647	0.312
C1836	POM	Natural	10.40	2.80	12.40	21.30	7.40	0.406	0.109	0.484	0.831	0.289
C1880	POM	Natural	10.95	2.00	12.40	20.31	7.80	0.427	0.078	0.484	0.792	0.304
C3053	PA	Black/ Green	11.00	2.80	11.20	16.50	7.60	0.429	0.109	0.437	0.644	0.296
C3208	POM	Black	10.00	3.30	11.30	18.20	7.15	0.390	0.129	0.441	0.710	0.279
C3438	POM	Natural	8.60	1.90	6.00	14.15	11.00	0.335	0.074	0.234	0.552	0.429
C3439	POM	Natural	8.60	1.75	7.10	14.20	7.80	0.335	0.068	0.277	0.554	0.304
C3521	POM	Natural	8.00	1.55	5.70	14.00	11.00	0.312	0.060	0.222	0.546	0.429
C3589	POM	Orange	7.80	1.70	9.80	16.35	7.90	0.304	0.066	0.382	0.638	0.308
C3786	POM	Black	8.20	2.10	8.20	14.20	13.60	0.320	0.082	0.320	0.554	0.530
C3854	POM	Natural	10.00	2.90	10.80	17.90	7.50	0.390	0.113	0.421	0.698	0.293
C3879	POM	Red	6.40	1.30	6.40	15.10	7.00	0.250	0.051	0.250	0.589	0.273
C3884	POM	Orange	8.30	3.00	9.50	15.05	6.80	0.324	0.117	0.371	0.587	0.265
C4010	POM	Natural	6.90	1.65	4.00	8.95	8.00	0.269	0.064	0.156	0.349	0.312

# INSTRUMENT & SIDE PANEL CLIP

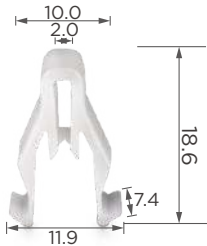

C0887

**Material:** POM  
**Color:** White/ Beige  
*Dashboard, console, audio, rear panel*

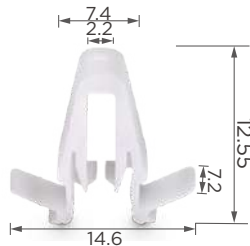

C0993

**Material:** POM  
**Color:** Natural  
*Front door*

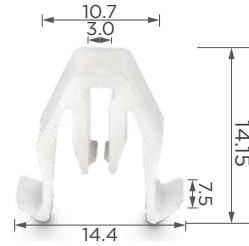

C1143

**Material:** POM  
**Color:** White  
*Grille, front bumper*

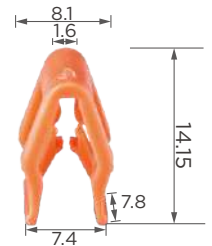

C1191

**Material:** POM  
**Color:** Orange  
*Instrument & side panel clip*

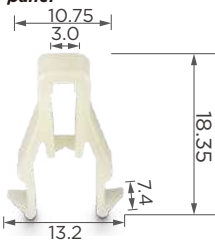

C1311

**Material:** PA  
**Color:** White  
*Instrument & side panel clip*

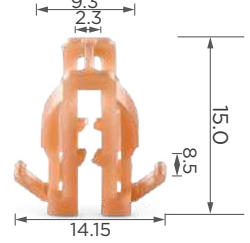

C1567

**Material:** PA  
**Color:** Orange  
*Instrument & side panel clip*

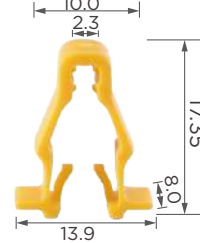

C1710

**Material:** POM  
**Color:** Yellow  
*Front bumper, fender flare*

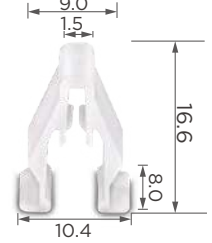

C1778

**Material:** POM  
**Color:** Natural  
*Door panel, console, dashboard, back seat, splash guard*



C1836

**Material:** POM  
**Color:** Natural  
*Instrument & side panel clip*

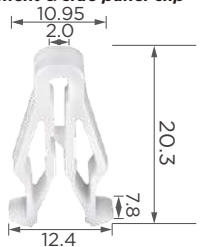

C1880

**Material:** POM  
**Color:** Natural  
*Instrument & side panel clip*

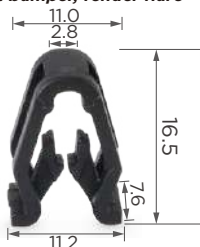

C3053

**Material:** PA  
**Color:** Black/ Green  
*Pillar, rear panel*

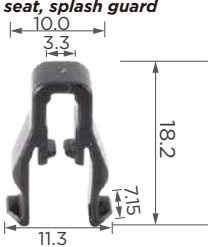

C3208

**Material:** POM  
**Color:** Black  
*Instrument & side panel clip*

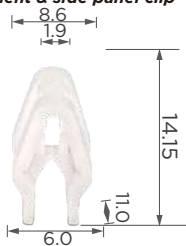

C3438

**Material:** POM  
**Color:** Natural  
*Instrument & side panel clip*

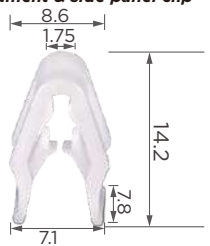

C3439

**Material:** POM  
**Color:** Natural  
*Instrument & side panel clip*

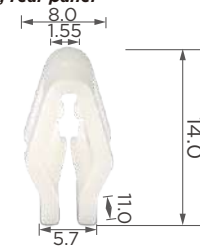

C3521

**Material:** POM  
**Color:** Natural  
*Instrument & side panel clip*

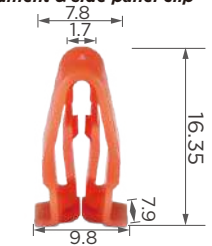

C3589

**Material:** POM  
**Color:** Orange  
*Instrument & side panel clip*

## INSTRUMENT & SIDE PANEL CLIP



C3786

**Material:** POM

**Color:** Black

**Interior liftgate**

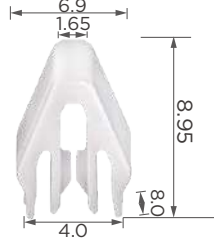

C4010

**Material:** POM

**Color:** Natural

**Pillar, trunk interior trim**

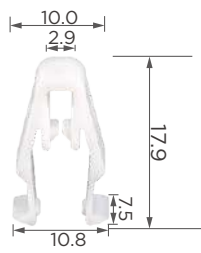

C3854

**Material:** POM

**Color:** Natural

**Center console, taillight, dashboard, door panel**

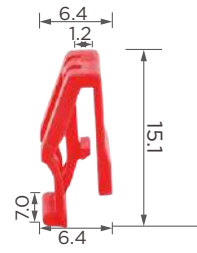

C3879

**Material:** POM

**Color:** Red

**C pillar panel trim cover**

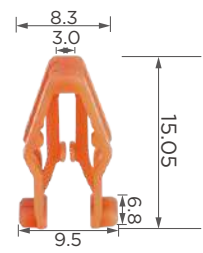

C3884

**Material:** POM

**Color:** Orange

**Dashboard, center console, side molding, taillight**

# — WINDOW RETAINER

**Product No.:** C1039

**Material:** POM  
**Color:** Black  
**Position:** Door window



Product Details

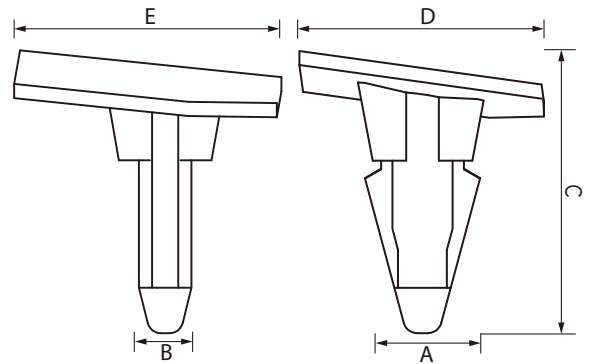

Part No.	Material	Color	mm					in				
			A	B	C	D	E	A	B	C	D	E
C1034	POM	Blue	11.70	7.50	15.00	39.50	35.40	0.456	0.293	0.585	1.541	1.381
C1035	POM	Red	12.00	7.70	21.50	49.70	20.35	0.468	0.300	0.839	1.938	0.794
C1036	PA	Black	5.65	4.20	11.90	50.15	11.10	0.220	0.164	0.464	1.956	0.433
C1037	POM	Black	11.50	6.00	28.70	30.10	25.61	0.449	0.234	1.119	1.174	0.999
C1038	POM	Black	11.65	5.90	25.55	30.00	25.60	0.454	0.230	0.996	1.170	0.998
C1039	POM	Black	11.70	6.00	30.00	29.90	25.75	0.456	0.234	1.170	1.166	1.004
C1040	POM	Black	11.50	6.00	30.00	30.00	26.25	0.449	0.234	1.170	1.170	1.024
C1055	POM	Yellow	11.70	7.50	15.00	39.20	35.50	0.456	0.293	0.585	1.529	1.385
C1366	POM	Black	12.00	5.90	26.70	26.00	26.10	0.468	0.230	1.041	1.014	1.018
C1369	POM	Black	12.25	6.00	24.89	26.10	26.10	0.478	0.234	0.971	1.018	1.018
C1370	POM	Black	11.90	6.00	24.70	26.00	26.00	0.464	0.234	0.963	1.014	1.014
C1372	POM	Black	13.20	9.40	33.20	34.40	33.10	0.515	0.367	1.295	1.342	1.291
C1373	POM	Black	13.20	9.35	33.90	32.10	32.05	0.515	0.365	1.322	1.252	1.250
C1374	POM	Black	13.10	9.45	25.50	40.35	32.20	0.511	0.369	0.995	1.574	1.256
C1375	POM	Black	12.95	9.40	25.40	40.35	32.10	0.505	0.367	0.991	1.574	1.252

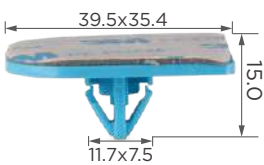

C1034

**Material:** POM  
**Color:** Blue  
**Door window**

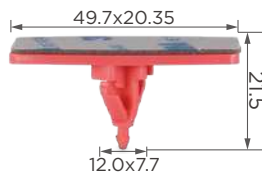

C1035

**Material:** POM  
**Color:** Red  
**Door window**



C1036

**Material:** PA  
**Color:** Black  
**Door window**



C1037

**Material:** POM  
**Color:** Black  
**Door window**



# WINDOW RETAINER



C1038

**Material:** POM  
**Color:** Black  
**Door window**



C1039

**Material:** POM  
**Color:** Black  
**Door window**



C1040

**Material:** POM  
**Color:** Black  
**Door window**

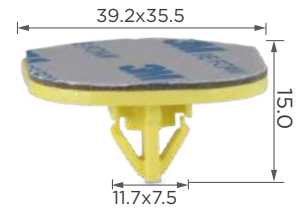

C1055

**Material:** POM  
**Color:** Black  
**Door window**



C1366

**Material:** POM  
**Color:** Black  
**Door window**



C1369

**Material:** POM  
**Color:** Black  
**Door window**



C1370

**Material:** POM  
**Color:** Black  
**Door window**



C1372

**Material:** POM  
**Color:** Black  
**Door window**

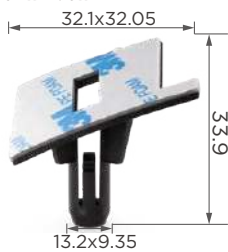

C1373

**Material:** POM  
**Color:** Black  
**Door window**

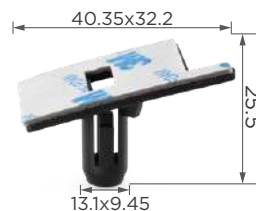

C1374

**Material:** POM  
**Color:** Black  
**Door window**



C1375

**Material:** POM  
**Color:** Black  
**Door window**

# PILLAR TRIM CLIP WITH METAL SPRING

**Product No.:** C3820

**Material:** PA  
**Color:** Blue  
**Position:** Liftfate trim

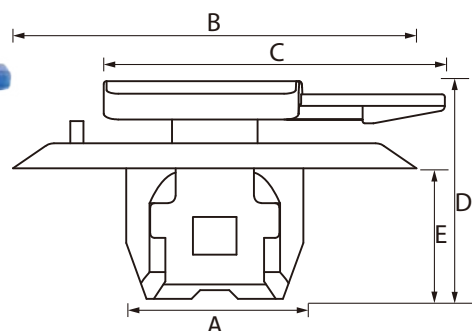
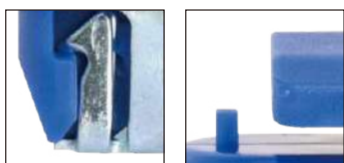

Part No.	Material	Color	mm					in				
			A	B	C	D	E	A	B	C	D	E
C3197	POM	Black	7.0x7.86	28.15x14.45	20.25x16.8	18.40	12.20	0.273X0.307	1.098X0.564	0.790X0.655	0.718	0.476
C3198	POM	Blue	7.1x7.6	28.2x14.55	20.25x16.8	16.15	9.95	0.277X0.296	1.099X0.567	0.790X0.655	0.630	0.388
C3764	POM	Green	8.45x7.8	28.0x14.8	20.15x16.8	17.50	11.00	0.330X0.304	0.786X0.577	0.786X0.655	0.683	0.429
C3767	PA	Red	12.5x7.65	28.0x14.45	24.0x16.9	15.90	9.30	0.488X0.298	1.092X0.564	0.936X0.659	0.620	0.363
C3820	PA	Blue	12.1X6.3	27.7X14.0	23.5X16.8	15.00	8.80	0.472X0.246	1.080X0.546	0.917X0.655	0.585	0.343

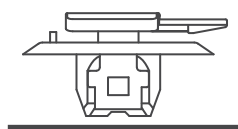

**C3197**

**Material:** POM  
**Color:** Black  
**Pillar**

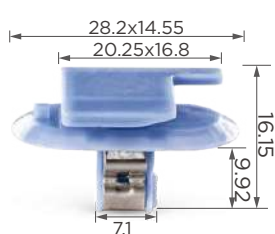

**C3198**

**Material:** POM  
**Color:** Blue  
**Pillar**

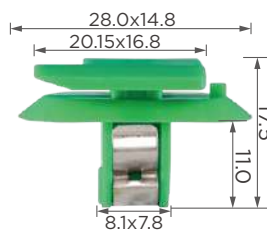

**C3764**

**Material:** POM  
**Color:** Green  
**Pillar, Rocker panel, Rear tray**

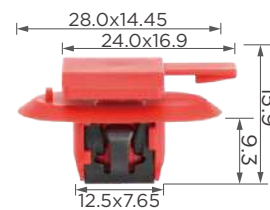

**C3767**

**Material:** PA  
**Color:** Red  
**Pillar, rear tray carpet**

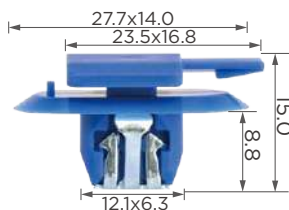

**C3820**

**Material:** PA  
**Color:** Blue  
**Liftgate panel trim**

# — WINDOW & ROOF DRIP CLIP

**Product No.:** C0062

**Material:** POM  
**Color:** White  
**Position:** Door window

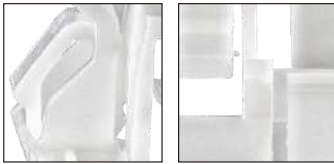

Product Details

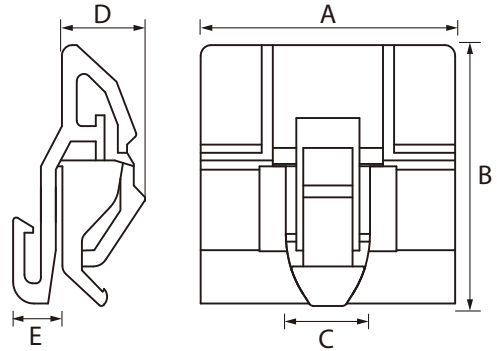

Part No.	Material	Color	mm					in				
			A	B	C	D	E	A	B	C	D	E
C0062	POM	White	24.80	23.75	8.10	7.05	4.00	0.967	0.926	0.316	0.275	0.156
C0640	POM	White	19.70	35.80	19.70	7.90	3.55	0.768	1.396	0.768	0.308	0.138
C0669	POM	White	18.70	34.35	18.70	7.35	6.90	0.729	1.340	0.729	0.287	0.269
C0683	POM	Red	19.50	24.10	14.70	6.00	4.85	0.761	0.940	0.573	0.234	0.189
C0810	POM	White	19.70	25.00	19.70	10.40	3.90	0.768	0.975	0.768	0.406	0.152
C1144	POM	White	18.40	37.50	18.40	13.00	6.30	0.718	1.463	0.718	0.507	0.246
C1308	POM	Natural	22.80	39.45	34.40	6.50	2.75	0.889	1.539	1.342	0.254	0.107
C1548	POM	Natural	24.85	27.80	18.50	10.50	3.20	0.969	1.084	0.722	0.410	0.125
C1835	POM	Brown	26.20	28.65	26.20	7.80	5.15	1.022	1.117	1.022	0.304	0.201
C1927	POM	Pink	20.00	28.65	20.00	7.95	4.45	0.780	1.117	0.780	0.310	0.174
C1929	POM	Green	20.10	37.95	20.10	9.00	2.55	0.784	1.480	0.784	0.351	0.099
C3164	POM	Natural	20.00	36.55	20.00	8.50	2.70	0.780	1.425	0.780	0.332	0.105
C3395	POM	Natural	20.00	25.10	10.00	5.00	4.80	0.780	0.979	0.390	0.195	0.187
C3487	POM	Green	32.00	19.12	13.80	6.00	4.00	1.248	0.746	0.538	0.234	0.156
C3495	PA	Natural	27.30	28.70	13.80	6.30	6.00	1.065	1.119	0.538	0.246	0.234
C3594	POM	Light blue	20.00	36.40	20.00	8.60	4.90	0.780	1.420	0.780	0.335	0.191
C3596	POM	Yellow	19.75	31.00	19.75	8.75	5.60	0.770	1.209	0.770	0.341	0.218

**Product No.:** C0082

**Material:** POM  
**Color:** White  
**Position:** Quarter belt reveal moulding

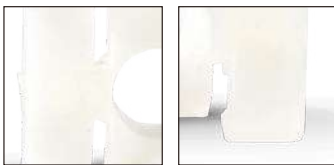

Product Details

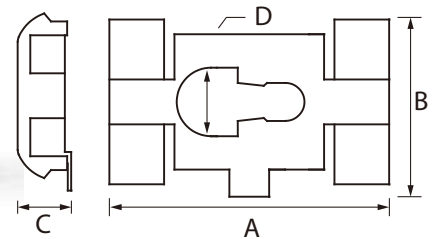

## — WINDOW & ROOF DRIP CLIP

Part No.	Material	Color	mm				in			
			A	B	C	D	A	B	C	D
C0082	POM	White	24.35	14.30	4.65	6.00	0.950	0.558	0.181	0.234
C0266	POM	Black	49.75	17.70	4.85	5.60	1.940	0.690	0.189	0.218
C0331	PA	Grey	21.50	13.00	4.35	5.40	0.839	0.507	0.170	0.211
C0408	POM	Light green/ Natural	19.30	18.70	5.30	5.80	0.753	0.729	0.207	0.226
C0409	PA	White	17.10	8.60	4.10	4.05	0.667	0.335	0.160	0.158
C0432	POM	Grey	49.30	14.00	5.50	5.70	1.923	0.546	0.215	0.222
C0437	POM	White	21.05	11.40	5.90	5.50	0.821	0.445	0.230	0.215
C0501	POM	White	24.70	11.00	4.00	5.90	0.963	0.429	0.156	0.230
C0662	POM	Light green	45.00	11.20	4.40	5.10	1.755	0.437	0.172	0.199
C0915	POM	White	30.90	8.10	5.10	3.30	1.205	0.316	0.199	0.129
C3029	POM	Black	40.50	16.00	6.05	3.25	1.580	0.624	0.236	0.127
C3469	POM	Grey	84.30	14.50	5.65	3.20	3.288	0.566	0.220	0.125

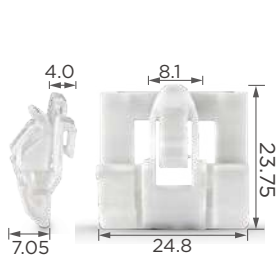
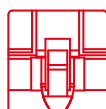

C0062

**Material:** POM  
**Color:** White  
**Door window**

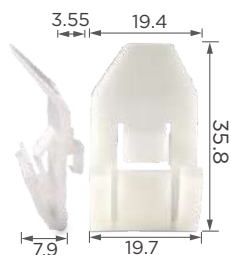

C0640

**Material:** POM  
**Color:** White  
**Door window**



C0669

**Material:** POM  
**Color:** White  
**Door window**

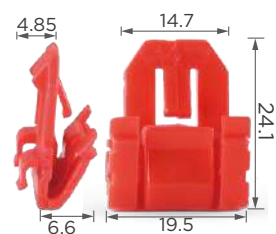

C0683

**Material:** POM  
**Color:** Red  
**Door window**



C0810

**Material:** POM  
**Color:** White  
**Door window**



C1144

**Material:** POM  
**Color:** White  
**Door window**

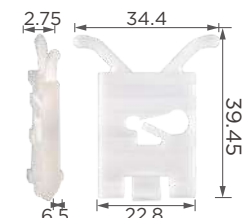

C1308

**Material:** POM  
**Color:** Natural  
**Door window**



C1548

**Material:** POM  
**Color:** Natural  
**Door window**

# WINDOW & ROOF DRIP CLIP

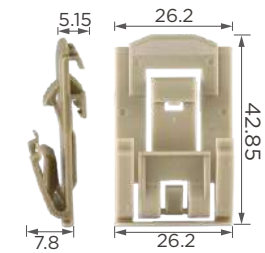

C1835

**Material:** POM  
**Color:** Brown  
**Door window**

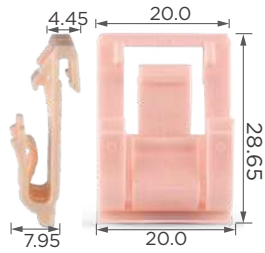

C1927

**Material:** POM  
**Color:** Pink  
**Door window**

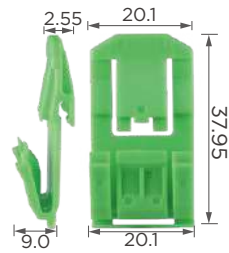

C1929

**Material:** POM  
**Color:** Green  
**Door window**



C3164

**Material:** POM  
**Color:** Natural  
**Door window**

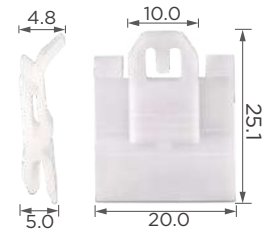

C3395

**Material:** POM  
**Color:** Natural  
**Quarter belt reveal moulding**

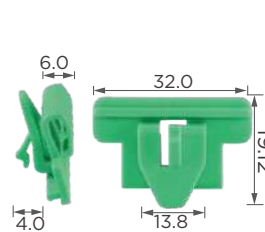

C3487

**Material:** POM  
**Color:** Green  
**Door window, roof drip**



C3495

**Material:** PA  
**Color:** Natural  
**Quarter belt reveal moulding**



C3594

**Material:** POM  
**Color:** Light blue  
**Door window**

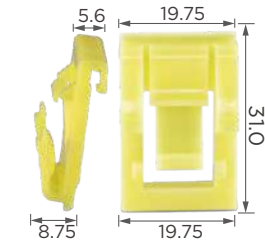

C3596

**Material:** POM  
**Color:** Yellow  
**Door window, roof drip**

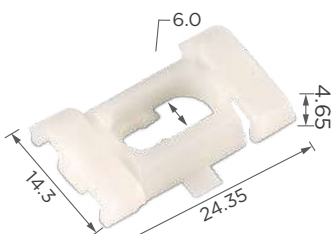
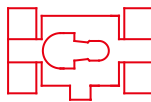

C0082

**Material:** POM  
**Color:** White  
**Quarter belt reveal moulding**

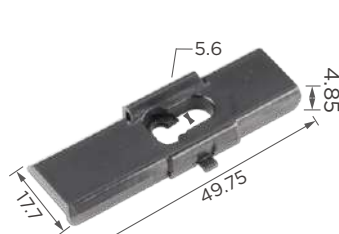

C0266

**Material:** POM  
**Color:** Black  
**Rear window**



C0331

**Material:** PA  
**Color:** Grey  
**Convertible top**

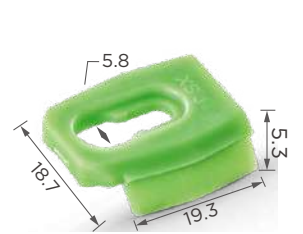

C0408

**Material:** POM  
**Color:** Light green  
**Quarter belt moulding**

## — WINDOW & ROOF DRIP CLIP



C0409

**Material:** PA  
**Color:** White  
**Side moulding**

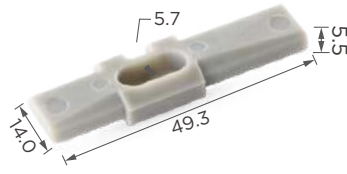

C0432

**Material:** POM  
**Color:** Grey  
**Side moulding**



C0437

**Material:** POM  
**Color:** White  
**Quarter belt reveal moulding**



C0501

**Material:** POM  
**Color:** White  
**Roof**

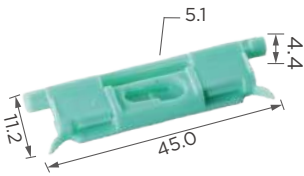

C0662

**Material:** POM  
**Color:** Light green  
**Windshield**

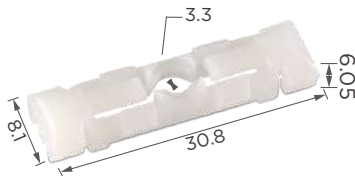

C0915

**Material:** POM  
**Color:** White  
**Door window**



C3029

**Material:** POM  
**Color:** Black  
**Rocker panel, side moulding**

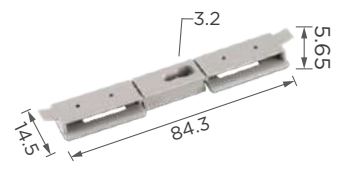

C3469

**Material:** POM  
**Color:** Grey  
**Front roof drip**



C3715

**Material:** PA  
**Color:** Natural  
**Landau top moulding clip**

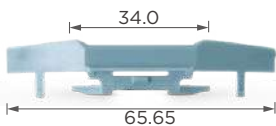

C0184

**Material:** PA  
**Color:** Light blue  
**Windshield**



C0055

**Material:** POM  
**Color:** Light blue  
**Side moulding**



C0399

**Material:** POM  
**Color:** Light blue  
**Windshield**



C0416

**Material:** POM  
**Color:** White  
**Windshield**



# — WINDOW & ROOF DRIP CLIP

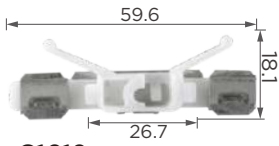

**C1612**

**Material:** POM  
**Color:** White  
**Windshield**



**C1621**

**Material:** POM  
**Color:** White  
**Windshield**

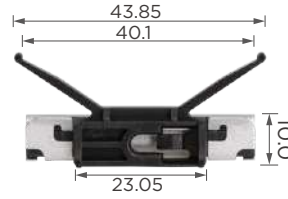

**C3922**

**Material:** POM+Metal  
**Color:** Black  
**Windshield**

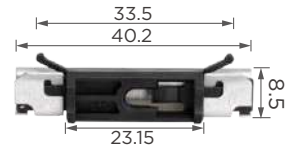

**C3923**

**Material:** POM+Metal  
**Color:** Black  
**Windshield**



**C1789**

**Material:** POM  
**Color:** White  
**Windshield**

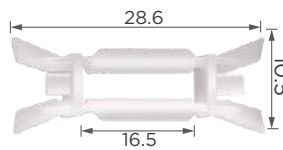

**C3168**

**Material:** POM  
**Color:** White  
**Door seal**



**C3065**

**Material:** POM  
**Color:** White  
**Windshield**



**C3323**

**Material:** POM  
**Color:** White  
**Side moulding**

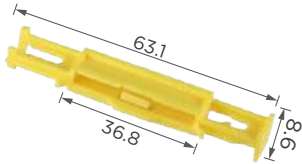

**C3321**

**Material:** POM  
**Color:** Yellow  
**Side moulding**



**C3322**

**Material:** POM  
**Color:** Dark grey  
**Side moulding**



**C3413**

**Material:** POM  
**Color:** Natural  
**Front roof drip**

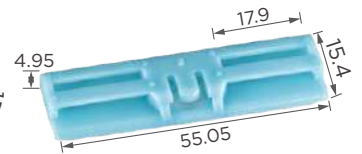

**C3606**

**Material:** POM  
**Color:** Blue  
**Windshield moulding**



**C3742**

**Material:** POM  
**Color:** Natural  
**Front Windshield**

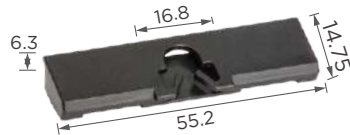

**C3830**

**Material:** POM  
**Color:** Black  
**Roof drip side finish moulding**

# GRILLE CLIP

**Product No.:** C1039

**Material:** POM  
**Color:** Black  
**Position:** Door window



Product Details

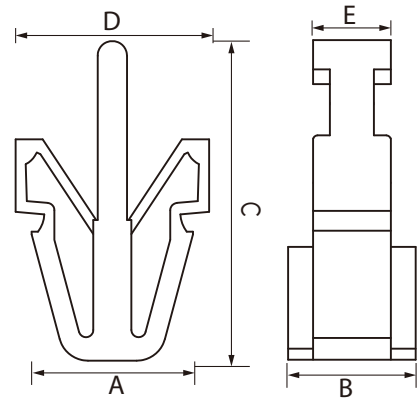

Part No.	Material	Color	mm					in				
			A	B	C	D	E	A	B	C	D	E
C0014	POM	Black	11.10	8.60	21.70	13.10	5.30	0.433	0.335	0.846	0.511	0.207
C0015	POM	Black	11.05	8.45	22.05	12.20	5.10	0.431	0.330	0.860	0.476	0.199
C0016	POM	Black	16.65	7.20	21.70	21.30	5.30	0.649	0.281	0.846	0.831	0.207
C0263	PA	Black	10.21	6.60	22.90	17.30	4.70	0.398	0.257	0.893	0.675	0.183
C0545	PA	Grey/Black	11.40	6.00	22.00	18.60	7.60	0.445	0.234	0.858	0.725	0.296
C1632	POM	Black	11.10	5.95	25.80	17.80	7.45	0.433	0.232	1.006	0.694	0.291



C0014

**Material:** POM  
**Color:** Black  
**Grille**



C0015

**Material:** POM  
**Color:** Black  
**Grille**

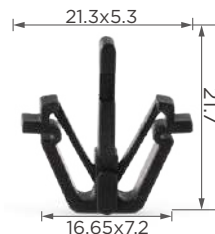

C0016

**Material:** POM  
**Color:** Black  
**Grille**

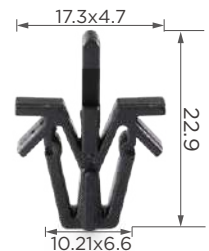

C0263

**Material:** PA  
**Color:** Black  
**Grille**



C0545

**Material:** PA  
**Color:** Grey/ Black  
**Grille**



C1632

**Material:** POM  
**Color:** Black  
**Grille**

## — GRILLE CLIP

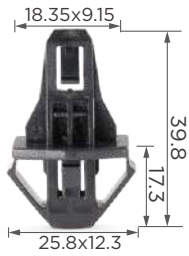

C0076

**Material:** POM  
**Color:** Black  
**Grille**

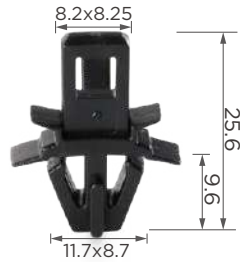

C0647

**Material:** POM  
**Color:** Black  
**Grille**

# OIL DRAIN PLUG GASKET

**Product No.:** C0537

**Material:** PA  
**Color:** Beige  
**Position:** Oil drain plug

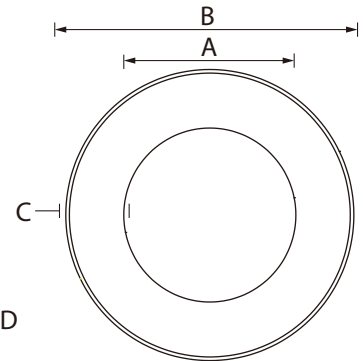
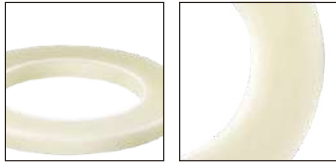

Part No.	Material	Color	mm				in			
			A	B	C	D	A	B	C	D
C0536	PA	Beige	16.50	25.90	4.70	2.05	0.644	1.010	0.183	0.080
C0550	PA	Beige	19.55	27.45	3.95	2.50	0.762	1.071	0.154	0.098
C0537	PA	Beige	12.45	22.60	5.07	1.30	0.486	0.881	0.198	0.051
C0314	PA	Beige	14.40	24.30	4.95	1.15	0.562	0.948	0.193	0.045
C0315	PA	Beige	13.15	24.15	5.50	1.25	0.513	0.942	0.215	0.049
C1673	PA	Black	26.20	37.20	5.50	2.40	1.022	1.451	0.215	0.094
C3063	PA	Black	17.85	5.50	6.12	1.10	0.696	0.215	0.239	0.043
C3657	PA	White	14.15	24.00	4.93	1.55	0.552	0.936	0.192	0.060
C3846	PA	White	24.00	13.00	5.50	1.75	0.936	0.507	0.215	0.068
C3849	PA	Black	17.50	12.50	2.50	0.80	0.683	0.488	0.098	0.031
C3919	PA	Natural	12.70	9.40	1.65	1.14	0.495	0.367	0.064	0.044



**C0314**

**Material:** PA  
**Color:** Beige  
**Oil drain plug**

**C0315**

**Material:** PA  
**Color:** Beige  
**Oil drain plug**

**C0536**

**Material:** PA  
**Color:** Beige  
**Oil drain plug**

**C0537**

**Material:** PA  
**Color:** Beige  
**Oil drain plug**

## OIL DRAIN PLUG GASKET

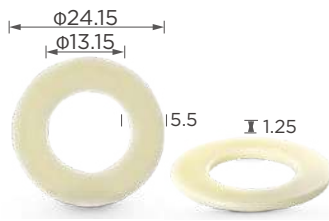

C0550

**Material:** PA  
**Color:** Beige  
**Oil drain plug**



C1673

**Material:** PA  
**Color:** Black  
**Oil drain plug**

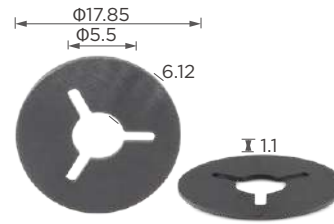

C3062

**Material:** PA  
**Color:** Black  
**Fuel pump, rear bumper, grille**

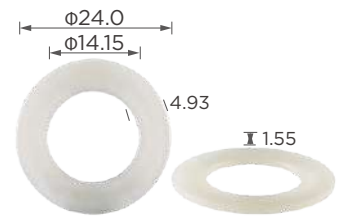

C3657

**Material:** PA  
**Color:** White  
**Oil drain plug**

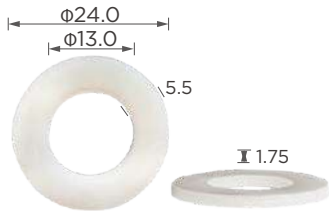

C3846

**Material:** PA  
**Color:** White  
**Washer & gasket**



C3849

**Material:** PA  
**Color:** Black  
**Washer & gasket**

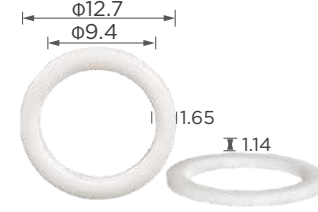

C3919

**Material:** PA  
**Color:** Natural  
**Gasket**

## SEATING CLIP

**Product No.:** C1569

**Material:** PA + POM  
**Color:** White + Black  
**Position:** Rear seat cushion

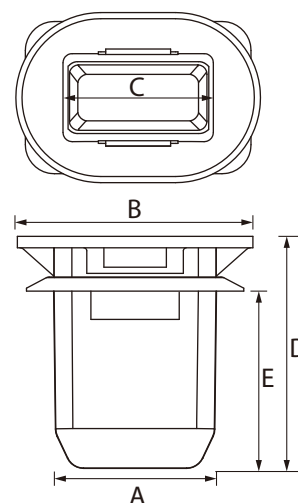
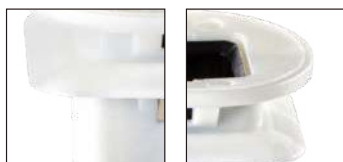

Part No.	Material	Color	mm					in				
			A	B	C	D	E	A	B	C	D	E
C1569	PA+POM	White +Black	26.9x15.55	40.0x27.3	24.65x14.3	39.60	30.10	1.049X0.606	1.56x1.065	0.961x0.558	1.544	1.174
C1570	POM	Black	27.15x15.2	45.3x34.15	33.0x21.5	34.30	30.20	1.589x0.593	1.767x1.332	1.287x0.839	1.338	1.178
C3073	PA	White	27.0x15.55	40.0x27.3	24.65x14.3	39.60	30.10	1.053X0.606	1.56x1.065	0.961x0.558	1.544	1.174
C3333	POM	Grey	22.0x8.9	33.45x23.95	18.8x8.95	37.15	33.60	0.858x0.347	1.305x0.934	0.733x0.349	1.449	1.310
C3484	PA	Natural+Red	27.1x15.6	36.7x25.9	24.7x12.9	33.00	31.00	1.057x0.609	1.431x1.010	0.963x0.503	1.287	1.209
C3690	PA+POM	Black	27.2x18.2	31.95x21.7	23.65x5.95	30.80	15.35	1.061x0.710	1.246x0.846	0.922x0.232	1.201	0.599
C3811	POM	Black	26.7X15.75	37.8X26.1	24.9X13.0	33.60	31.20	1.041X0.614	1.474X1.018	0.971X0.507	1.310	1.217
C3841	POM	Natural	27.6x19.3	48.9x30.0	20.0x7.9	37.50	21.80	1.076x0.753	1.907x1.170	0.780x0.308	1.463	0.850
C3843	POM	Natural	31.1x18.0	51.1x35.5	28.2x14.05	30.40	21.10	1.213x0.702	1.993x1.385	1.099x0.548	1.186	0.823



**C1569**

**Material:** PA+POM  
**Color:** White+Black  
**Rear seat cushion**



**C1570**

**Material:** POM  
**Color:** Black  
**Rear seat cushion**



**C3073**

**Material:** PA  
**Color:** White  
**Rear seat cushion**



**C3333**

**Material:** POM  
**Color:** Grey  
**Rear seat cushion**



## SEATING CLIP



C3484

**Material:** PA

**Color:** Natural+Red

**Rear seat hook cushion**

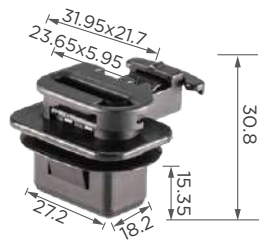

C3690

**Material:** PA

**Color:** Black

**Rear seat cushion**

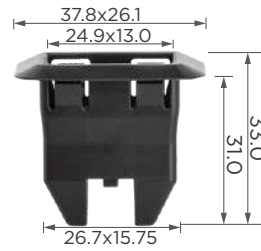

C3811

**Material:** POM

**Color:** Black

**Seat clip**



C3841

**Material:** POM

**Color:** Natural

**Seat clip**



C3843

**Material:** POM

**Color:** Natural

**Seat clip**

# SPECIALIZED PIN



C0124

**Material:** PA  
**Color:** Black  
**Roof, carpet**



C0210

**Material:** PA  
**Color:** White  
**Seat**



C0312

**Material:** PA  
**Color:** Black  
**Door flange, tailgate**



C0484

**Material:** PA  
**Color:** Black  
**Hood, cowl**



C0489

**Material:** PA  
**Color:** Black  
**Door panel**



C0596

**Material:** PA  
**Color:** Black  
**Hood, heat**

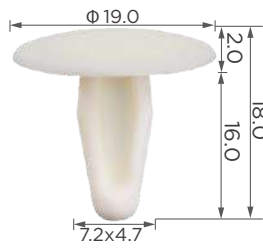

C3847

**Material:** PA  
**Color:** Natural  
**Mounting button**



C0892

**Material:** PA  
**Color:** Black  
**Radiator top shield**



C1290

**Material:** Nylon  
**Color:** White  
**Retainer**



C3001

**Material:** POM  
**Color:** Black  
**Door panel**



C3275

**Material:** POM  
**Color:** Black  
**Front and rear axle**



C0931

**Material:** POM  
**Color:** White  
**Door sill, rocker panel**



C3292

**Material:** POM  
**Color:** Yellow  
**Door sill, rocker panel**



C0013

**Material:** PA  
**Color:** White  
**Rear tray, door panel**



C0165

**Material:** PA  
**Color:** Black  
**Door panel**



C0285

**Material:** Nylon  
**Color:** Black + White  
**Cowl**



C0290

**Material:** PA  
**Color:** Black  
**Rear windshield**



C0579

**Material:** PA  
**Color:** Black  
**Cowl**



C1922

**Material:** POM  
**Color:** Black  
**Wheelarch, splash guard**



C3472

**Material:** POM  
**Color:** Black  
**Under cover, rear inner, fender, wheelarch**

## SPECIALIZED PIN



C3706

**Material:** PA  
**Color:** Black  
**Rear fender, grille, finish molding upper retainer**



C1558

**Material:** POM  
**Color:** Black  
**Door sill, rocker panel, bottom**



C1468

**Material:** PA  
**Color:** Black  
**Cowl**



C3686

**Material:** POM  
**Color:** Green  
**Rear panel, rear bumper**



C1469

**Material:** PA  
**Color:** Black  
**Fastener**



C0962

**Material:** POM  
**Color:** Black  
**Wheelarch, splash guard**



C1592

**Material:** POM  
**Color:** Black  
**Door sill**



C1608

**Material:** PA  
**Color:** Black  
**Front and rear bumper**



C1175

**Material:** PA  
**Color:** Black  
**Hood**



C1551

**Material:** PA  
**Color:** Black  
**Wheelarch, splash guard, under engine**



C3451

**Material:** PA  
**Color:** Black  
**Specialized pin**



C1974

**Material:** PA  
**Color:** Black  
**Rocker panel, floor**



C1747

**Material:** POM  
**Color:** Black  
**Door panel**



C1176

**Material:** PA  
**Color:** Black  
**Hood**



C1846

**Material:** POM  
**Color:** Black  
**Rear bumper**



C1111

**Material:** PA  
**Color:** Black  
**Rear tray**



C1405

**Material:** PA  
**Color:** Black  
**Fasteners**



C3166

**Material:** POM  
**Color:** Black  
**Wheelarch, splash guard**



C1409

**Material:** PA  
**Color:** Black  
**Fuel pump**



C1554

**Material:** PA  
**Color:** Black  
**Pin**

# SPECIALIZED PIN



C3542

**Material:** POM  
**Color:** Black  
**Front and rear bumper, heat insulation**



C1559

**Material:** PA  
**Color:** Black  
**Door panel**



C0937

**Material:** POM  
**Color:** White  
**Rocker panel**



C1535

**Material:** PA  
**Color:** Black  
**Rear bumper and bracket**



C1827

**Material:** POM  
**Color:** White  
**Floor, footrest**



C1456

**Material:** PA  
**Color:** Light green  
**Rocker panel**



C0651

**Material:** POM  
**Color:** Black  
**Front and rear bumper**



C0968

**Material:** POM  
**Color:** Black  
**Fender**



C1596

**Material:** PA  
**Color:** Pink  
**Rear panel, door panel**



C3502

**Material:** PA  
**Color:** Black  
**Rocker panel**

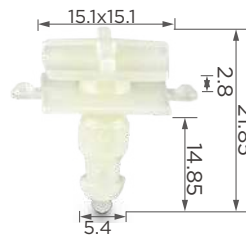

C3034

**Material:** PA  
**Color:** Light green  
**Fastener**



C0675

**Material:** PA  
**Color:** Black  
**Rocker panel**



C1273

**Material:** PA  
**Color:** Black  
**Rear bumper**



C1600

**Material:** PA  
**Color:** Black  
**Rear panel, door panel**

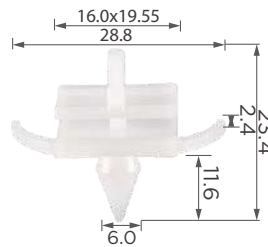

C3668

**Material:** POM  
**Color:** Natural  
**Rocker panel**



C1545

**Material:** PA  
**Color:** Black/ Blue  
**Door panel**

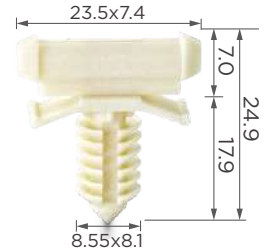

C0821

**Material:** PA  
**Color:** Natural  
**Fasteners**



C1473

**Material:** PA  
**Color:** Black  
**Door panel**



C1730

**Material:** PA  
**Color:** Black  
**Rocker panel**



C3873

**Material:** PA  
**Color:** Black  
**Tail light**

## SPECIALIZED PIN



C3890

**Material:** POM

**Color:** Black

**Trunk, dashboard, headlight**



C3920

**Material:** PA

**Color:** Black

**Clip**

# SPECIALIZED PLUG

## 1. Screw Cover & Base



**C1070**  
**Material:** PA  
**Color:** Grey/ light yellow/ dark blue  
*Screw cap cover*



**C1120**  
**Material:** PA  
**Color:** Dark grey/ grey  
*Screw cap cover*



**C1218**  
**Material:** PA  
**Color:** Grey/ Yellow/ Light brown  
*Screw cap cover*



**C1342**  
**Material:** PA  
**Color:** Grey/ Black/ Red/ Yellow  
*Screw cap cover*



**C3800**  
**Material:** PA  
**Color:** White  
*POP-ON screw cover*



**C3857**  
**Material:** PA  
**Color:** Natural  
*Pop-on screw cover base*



**C3858**  
**Material:** PA  
**Color:** Black  
*Pop-on screw cover base*

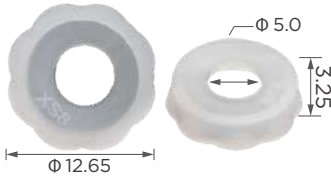

**C3859**  
**Material:** PA  
**Color:** Natural  
*Pop-on screw cover base*

## 2. Seat Belt Button

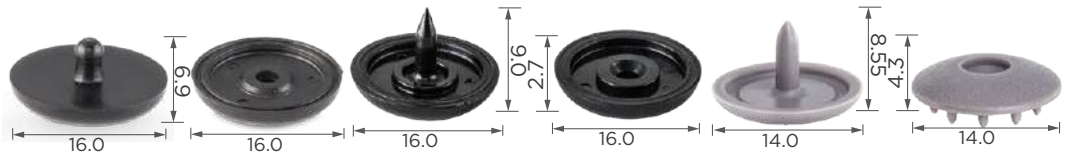

**C3339**  
**Material:** POM  
**Color:** Black  
*Seat belt button*

**C3755**  
**Material:** POM  
**Color:** Black  
*Seat belt button*

**C4012**  
**Material:** POM  
**Color:** Grey  
*Seat belt stopper*

## 3. Bolt Washer



**C1693**  
**Material:** PA  
**Color:** Black  
*Wheelarch, bottom, rear tray*



**C3391**  
**Material:** PA  
**Color:** Black  
*Wheelarch, underdoby*



## — SPECIALIZED PLUG

### 4. Engine Cover Cap



C1424

**Material:** PA  
**Color:** Black  
**Plug**



C1429

**Material:** PA  
**Color:** Black  
**Plug**



C1435

**Material:** PA  
**Color:** Black  
**Plug**

### 5. Under Cover Engine Push



C3645

**Material:** PA  
**Color:** Black  
**Plug**



C3762

**Material:** PA  
**Color:** Black  
**Front under shield**

### 6. Other Specialized Plug



C1002

**Material:** PA  
**Color:** Black  
**Front panel, windshield**



C1031

**Material:** PA  
**Color:** White  
**Plug**



C1365

**Material:** PA  
**Color:** Black  
**Plug**

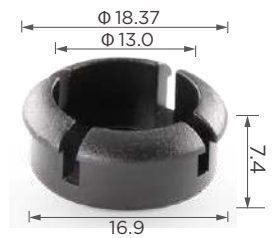

C1406

**Material:** POM  
**Color:** Black  
**Plug**



C1816

**Material:** PA  
**Color:** Black  
**Carpet, floor**



C1817

**Material:** PA  
**Color:** Black  
**Carpet, floor**



C3061

**Material:** PA  
**Color:** Black  
**Carpet, floor**



C3307

**Material:** PA  
**Color:** Black  
**Plug**

## SPECIALIZED PLUG



C3687

**Material:** POM  
**Color:** Natural  
**Fender flare**

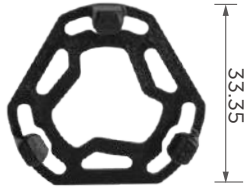

C3827

**Material:** PA  
**Color:** Black  
**Under shield**



C3945

**Material:** POM  
**Color:** Black  
**Undershield**



C3946

**Material:** POM  
**Color:** Black  
**Undershield**

# SPECIALIZED RETAINER

## 1. Fuel Line Clip



**C0581**

**Material:** PA  
**Color:** Light grey  
**Fuel line**



**C1113**

**Material:** PA  
**Color:** White  
**Fuel line**

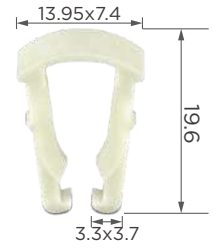

**C3422**

**Material:** PA  
**Color:** Light green  
**Vapor canister line, full supply system**



**C3455**

**Material:** PA  
**Color:** Black  
**Fuel pump**

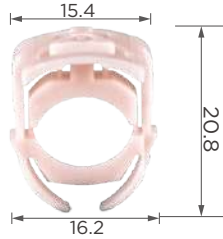

**C1837**

**Material:** POM  
**Color:** Pink  
**Fuel liner**

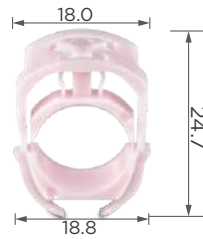

**C1860**

**Material:** POM  
**Color:** Pink  
**Fuel liner**

## 2. Bundling Clip



**C1047**

**Material:** PA  
**Color:** White  
**Routing & securing cable sets**

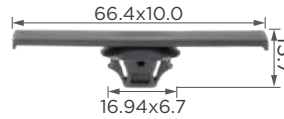

**C1052**

**Material:** PA  
**Color:** Black  
**Routing & securing cable sets**



**C1156**

**Material:** POM  
**Color:** White  
**Routing & securing cable sets**



**C1157**

**Material:** PA  
**Color:** Black  
**Routing & securing cable sets**



**C1158**

**Material:** PA  
**Color:** Black  
**Routing & securing cable sets**



**C1164**

**Material:** PA  
**Color:** White  
**Routing & securing cable sets**



**C1202**

**Material:** POM  
**Color:** White  
**Routing & securing cable sets**



**C1351**

**Material:** PA  
**Color:** Black  
**Routing & securing cable sets**

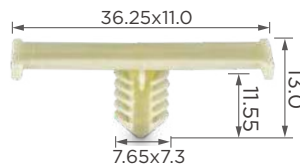

**C1508**

**Material:** PA  
**Color:** Beige  
**Routing & securing cable sets**



**C1594**

**Material:** PA  
**Color:** Black  
**Routing & securing cable sets**

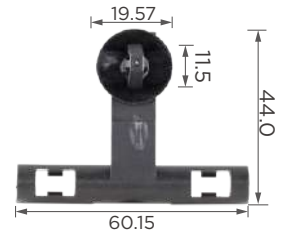

**C1814**

**Material:** PA  
**Color:** Black  
**Routing & securing cable sets**

## SPECIALIZED RETAINER

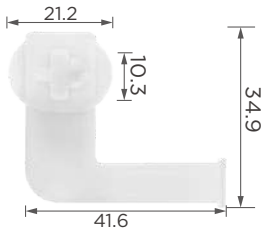

C1815

**Material:** PA  
**Color:** Natural  
**Routing & securing cable sets**

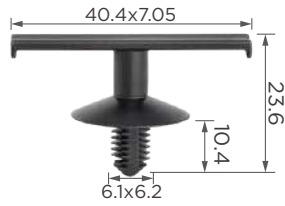

C3871

**Material:** PA  
**Color:** Black  
**Bundling clip**

### 3. Door Lock Pawl Retainer



C0561

**Material:** POM  
**Color:** Brown  
**Door lock pawl**



C0562

**Material:** POM  
**Color:** Pink  
**Door lock pawl**



C3607

**Material:** POM+ Metal  
**Color:** Natural  
**Door lock pawl**

### 4. Tube Suspension Clamp



C1058

**Material:** PE  
**Color:** Black  
**Tube suspension**

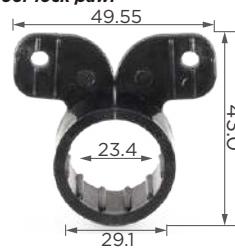

C1059

**Material:** PE  
**Color:** Black  
**Tube suspension**



C1060

**Material:** PE  
**Color:** Black  
**Tube suspension**

### 5. Foam Strip



C1215

**Material:** PET  
**Color:** Black  
**Foam strip**



C1216

**Material:** PET  
**Color:** Black  
**Foam strip**

### 6. Foam Pad Cushion

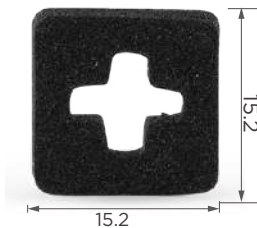

C1335

**Material:** CR  
**Color:** Black  
**Foam pad**

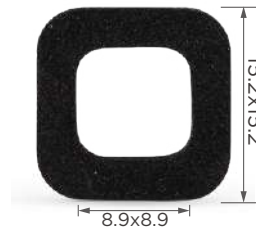

C1364

**Material:** CR  
**Color:** Black  
**Foam pad**

## SPECIALIZED RETAINER

### 7. Windshield Wash Hose Clip

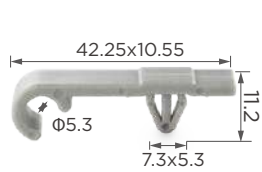

C0127

**Material:** PA  
**Color:** Grey  
**Windshield washer hose**



C1653

**Material:** PA  
**Color:** Natural  
**Interior pillar**

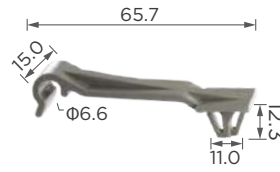

C0696

**Material:** POM  
**Color:** Grey  
**Windshield washer tube**

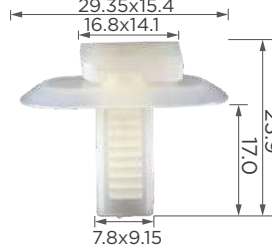

C3512

**Material:** PA  
**Color:** White  
**Back panel, rear tray**



C3652

**Material:** POM  
**Color:** Natural  
**Front windshiled**

### 8. Panel Clip

### 9. Door Seal Clip



C3019

**Material:** POM  
**Color:** Black  
**Door seal**



C3064

**Material:** POM  
**Color:** Black  
**Door seal**

### 10. Door Moulding Fastener

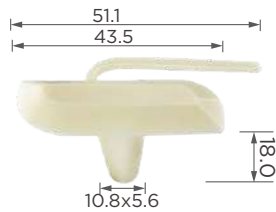

C0316

**Material:** PA  
**Color:** Beige  
**Door moulding**



C0318

**Material:** PA  
**Color:** Beige  
**Door moulding**



C3403

**Material:** PA  
**Color:** Beige  
**Front and rear door moulding**



C3915

**Material:** PA  
**Color:** Beige  
**Rear fender lower moulding**

## SPECIALIZED RETAINER

### 11. Combined Clip



C0908

**Material:** POM  
**Color:** White+Grey  
**Rear mirror**



C0921

**Material:** POM  
**Color:** Black  
**Door panel**

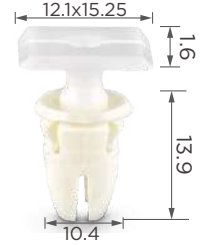

C1955

**Material:** POM  
**Color:** White  
**Door panel**



C3163

**Material:** POM  
**Color:** White  
**Side sill garnish**



C3204

**Material:** POM  
**Color:** Natural  
**Retainer**



C3213

**Material:** PA + POM  
**Color:** Black+White  
**Retainer**



C3214

**Material:** PA + POM  
**Color:** Black+White  
**Retainer**



C3663

**Material:** POM  
**Color:** Black + Grey  
**Fender flare, rocker panel**



C3548

**Material:** PA+POM  
**Color:** Grey+Black  
**Cowl, lower**



C3680

**Material:** POM  
**Color:** Natural+Black  
**Rocker panel, pillar**



C3707

**Material:** PA  
**Color:** Black+White  
**Taillight water gutter**



C4034

**Material:** POM+PA  
**Color:** Natural  
**Door sill trim**

### 12. Round Covering Insert



C1126

**Material:** POM  
**Color:** Black  
**Closing unnecessary holes**



C1201

**Material:** PA  
**Color:** Black  
**Closing unnecessary holes**



# SPECIALIZED RETAINER

## 13. Cowl Vent Retainer



C1166

**Material:** POM  
**Color:** White  
**Cowl**

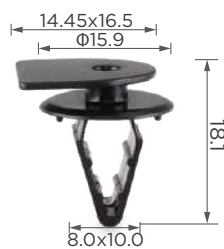

C3023

**Material:** POM  
**Color:** Black  
**Cowl**

## 14. Seat Runner Guide



C1417

**Material:** POM  
**Color:** White  
**Seat runner guide**

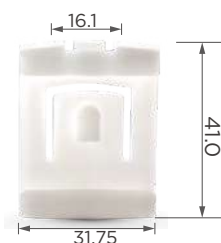

C1566

**Material:** POM  
**Color:** White  
**Seat runner guide**

## 15. Interior Door Trim Clip With Metal Inlay



C1432

**Material:** POM  
**Color:** Natural  
**Interior door trim**



C1433

**Material:** POM  
**Color:** Natural  
**Interior trim**



C1434

**Material:** POM  
**Color:** Natural  
**Interior trim**

## 16. Sun Visor Support



C1480

**Material:** ABS  
**Color:** Grey  
**Sun visor support**



C1485

**Material:** POM  
**Color:** Grey  
**Sun visor support**



C1490

**Material:** POM  
**Color:** Grey  
**Sun visor support**



C1486

**Material:** PA  
**Color:** Grey  
**Sun visor support**

## SPECIALIZED RETAINER

### 17. Rocker Panel Clip

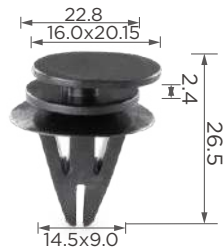

C1517

**Material:** POM  
**Color:** Black  
**Side moulding, rocker panel**



C1561

**Material:** POM  
**Color:** Red  
**Side moulding, rocker panel**

### 18. Spacer Clip



C1589

**Material:** POM  
**Color:** Black  
**Rocker panel, side moulding, underfloor**

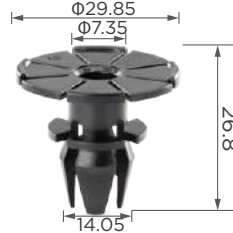

C1593

**Material:** POM  
**Color:** Black  
**Side moulding, rocker panel**

### 19. Wiper Panel Clip



C1630

**Material:** POM  
**Color:** Black  
**Cowl, wiper panel**

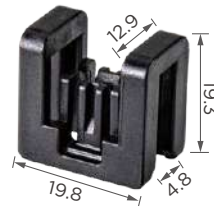

C3718

**Material:** POM  
**Color:** Black  
**Cowl, wiper panel, rear bumper**

### 20. Rear Bumper Cover

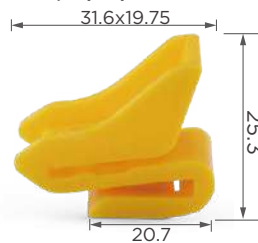

C1631

**Material:** POM  
**Color:** Yellow  
**Rear bumper**

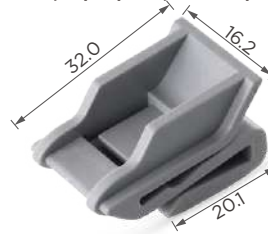

C3229

**Material:** POM  
**Color:** Grey  
**Rear bumper**

### 21. Headliner Clip



C1743

**Material:** POM  
**Color:** Black  
**Roof**

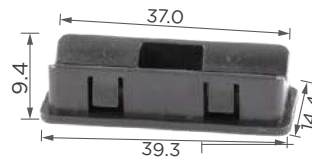

C1744

**Material:** POM  
**Color:** Black  
**Roof**

## SPECIALIZED RETAINER

### 22. Stopper



**C1861**  
**Material:** PP + TE  
**Color:** Black+White  
**Liftgate, door panel, hood**



**C1939**  
**Material:** PP + TPE  
**Color:** White + Black  
**Door panel**



**C3195**  
**Material:** TPV  
**Color:** Black  
**Door panel**



**C3237**  
**Material:** TPV  
**Color:** Black  
**Hood, liftgate**



**C3247**  
**Material:** TPV  
**Color:** Black  
**Hood**



**C3425**  
**Material:** TPE  
**Color:** Black  
**Body**

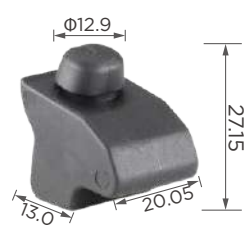

**C3429**  
**Material:** TPV  
**Color:** Black  
**Hood stop buffer**



**C3588**  
**Material:** TPV  
**Color:** Black  
**Door buffer block**



**C3623**  
**Material:** TPV  
**Color:** Black  
**Liftgate stopper**



**C3766**  
**Material:** TE  
**Color:** Black  
**Hood / bumper stopper**



**C3942**  
**Material:** TPE  
**Color:** Black  
**Hood stopper**

### 23. Bumper Fender Liner Clips



**C1856**  
**Material:** POM  
**Color:** Black  
**Front bumper**

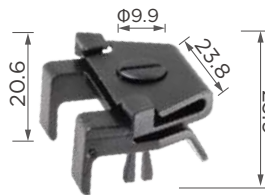

**C3448**  
**Material:** POM  
**Color:** Black  
**Wheelarch**



**C3449**  
**Material:** POM  
**Color:** Black  
**Wheelarch**

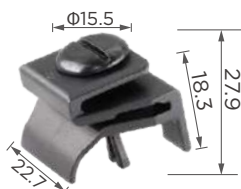

**C3450**  
**Material:** POM  
**Color:** Black  
**Wheelarch**



**C3758**  
**Material:** PA  
**Color:** Black  
**Front bumper**

## SPECIALIZED RETAINER

### 24. Window Guide Clip

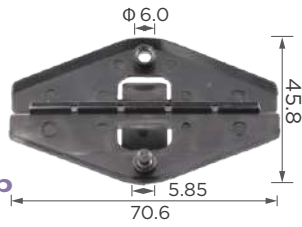

C0328

**Material:** PA  
**Color:** Black  
**Window**



C0517

**Material:** PA  
**Color:** Black  
**Window**

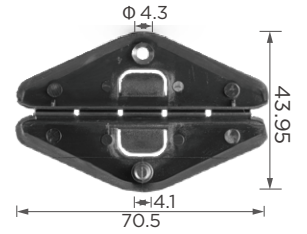

C0518

**Material:** PA  
**Color:** Black  
**Window**

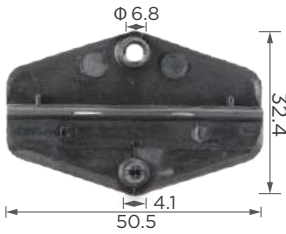

C0519

**Material:** PA  
**Color:** Black  
**Window**



C0520

**Material:** PA  
**Color:** Black  
**Window**



C0563

**Material:** PA  
**Color:** Black  
**Window**

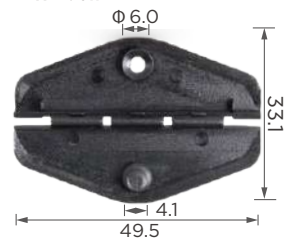

C0565

**Material:** PA  
**Color:** Black  
**Window**

### 25. Windshield Pillar Clip



C3081

**Material:** PA  
**Color:** Black  
**Pillar**



C3085

**Material:** PA  
**Color:** Black  
**Pillar**



C3093

**Material:** PA  
**Color:** Black  
**Front pillar**



C3683

**Material:** pa  
**Color:** Black  
**Front pillar**

### 26. Mat Clip



C1854

**Material:** PA  
**Color:** Black  
**Carpet, mat**



C1865

**Material:** PA  
**Color:** Black  
**Underfloor, mat**

## SPECIALIZED RETAINER

### 27. Rocker Panel Clip

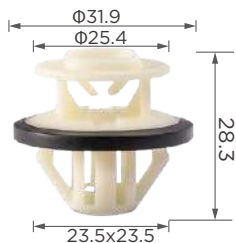

C1798

**Material:** PA  
**Color:** Beige  
**Side moulding, rocker panel**



C3335

**Material:** PA  
**Color:** Natural  
**Side moulding, rocker panel**

### 28. Turn Lock Clip



C0211

**Material:** PA  
**Color:** Black  
**Emission control, front end, rear bumper**



C1613

**Material:** POM  
**Color:** Black  
**Front bumper, splash guard**



C3569

**Material:** PA  
**Color:** Black  
**Trun locking**

### 29. Arm Bearing Clip



C3559

**Material:** TPU  
**Color:** Black  
**Rocker arm bearing**



C3575

**Material:** TPU  
**Color:** Black  
**Rocker arm bearing**



C3576

**Material:** TPU  
**Color:** Black  
**Rocker arm bearing**

### 30. Panel Clip With Hole



C1879

**Material:** POM  
**Color:** Grey  
**Rocker panel, sill**



C0237

**Material:** POM  
**Color:** White  
**Rocker panel, sill**



C0970

**Material:** POM  
**Color:** White  
**Rocker panel, sill, side moulding**



C1148

**Material:** POM  
**Color:** Yellow  
**Rocker panel, sill, side moulding**



C1958

**Material:** POM  
**Color:** White  
**Rocker panel, sill**



C3057

**Material:** POM  
**Color:** White  
**Rocker panel, sill, side moulding**

## — SPECIALIZED RETAINER

### 31. Cable Strap



C1053

**Material:** PA  
**Color:** Grey  
**Cable fixing**



C3430

**Material:** POM  
**Color:** Natural  
**Side moulding, rocker panel**



C1054

**Material:** PA  
**Color:** Grey  
**Side moulding**



C3436

**Material:** POM  
**Color:** Natural  
**Side moulding, rocker panel**

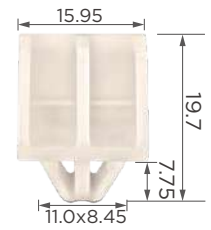

C3426

**Material:** POM  
**Color:** Natural  
**Side moulding, rocker panel**

### 32. Moulding Clip

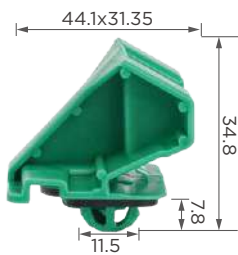

C3703

**Material:** POM  
**Color:** Green  
**Rocker panel, side skirt**



C3704

**Material:** POM  
**Color:** Natural  
**Rocker panel**

### 33. Door Handle Clip



C3486

**Material:** PA  
**Color:** Grey  
**Retainer**



C3489

**Material:** PA  
**Color:** Grey  
**Retainer**

### 34. Door Seal Proof Clip



C1032

**Material:** PA  
**Color:** Black  
**Door dust proof**



C1033

**Material:** PA  
**Color:** Black  
**Door dust proof**



## SPECIALIZED RETAINER

### 35. Front Bumper Side Support



C1514

**Material:** POM  
**Color:** Black  
**Front bumper side**

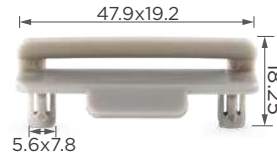

C1515

**Material:** POM  
**Color:** Grey  
**Front bumper side**

### 36. Combination Clips



C1123

**Material:** POM  
**Color:** Black  
**Rear Parcel shelf hook**



C1123-A



C1123-B



C1123-C



C1348

**Material:** POM  
**Color:** Black  
**Rear Parcel shelf hook**



C1348-A



C1348-B



C1123-C



C1183

**Material:** PA  
**Color:** Black  
**Retainer**



C1183 Body



C1183 Pin



C3396

**Material:** PA  
**Color:** Black  
**Retainer**



C3396 Body



C3396 Pin

# SPECIALIZED RETAINER



C3546

**Material:** POM  
**Color:** Black  
**Front bumper**

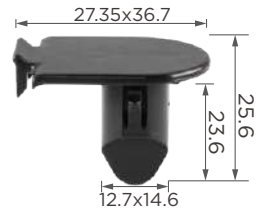

C3544

**Material:** POM  
**Color:** Black  
**Front bumper**

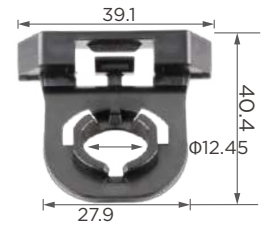

C3545

**Material:** POM  
**Color:** Black  
**Front bumper**

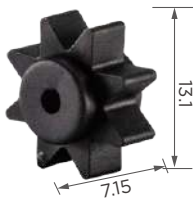

C3709

**Material:** TPV  
**Color:** Black  
**Electric power steering motor shaft**

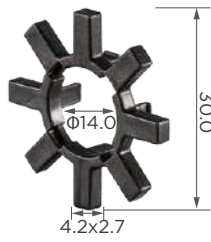

C3708

**Material:** POM  
**Color:** Dark grey  
**Column steering motor ring gear elastic coupling gear**

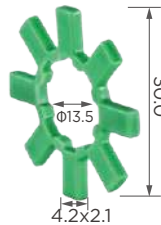

C3712

**Material:** TPU  
**Color:** Green  
**Column steering motor ring gear elastic coupling gear**



C3845

**Material:** TPU + POM  
**Color:** Green + Dark Grey  
**Column steering motor ring gear elastic coupling gear**

C3845 + C3709

## 37. Undershield Combination Clip

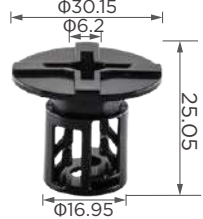

C1322-A

**Material:** POM  
**Color:** Black  
**Undershield, lower back panel**



C1322-B

**Material:** PA  
**Color:** White  
**Undershield, lower back panel**



C1322

**Material:** PA + POM  
**Color:** White + Black  
**Undershield, lower back panel**



C3947

**Material:** POM  
**Color:** Black  
**Undershield**



C3948

**Material:** PP  
**Color:** Natural  
**Undershield**



C3947+c3948

**Material:** POM+PP  
**Color:** Black+Natural  
**Undershield**

## 38. Side Molding Liner Clip

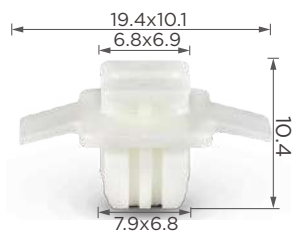

C1708

**Material:** PA  
**Color:** White  
**Side molding**

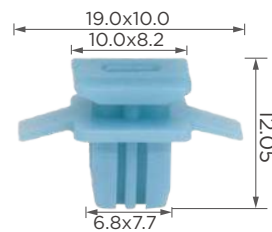

C3779

**Material:** PA  
**Color:** Light blue  
**Door belt molding pillar, front bumper**

# SPECIALIZED RETAINER

## 39. Knob Choke



C1779

**Material:** PA  
**Color:** Black  
**Retainer**



C1801

**Material:** PA  
**Color:** Black  
**Retainer**

## 40. Cap



C3612

**Material:** PA  
**Color:** Black  
**Retainer**



C3863

**Material:** PA  
**Color:** Black  
**Retainer**

## 41. Oil Drain Plug



C3713

**Material:** PA  
**Color:** Yellow  
**Oil drain plug**



C3714

**Material:** PA  
**Color:** Yellow  
**Oil drain plug**

## 42. Hollow Wall Anchor Clip

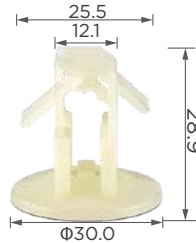

C1098

**Material:** PA  
**Color:** White  
**Underfloor, mat**



C1354

**Material:** PA  
**Color:** White  
**Retainer**



C3781

**Material:** PA  
**Color:** Natural  
**Carpet**

## 43. Cable Fixing Arrowhead Cradle



C1857

**Material:** POM  
**Color:** Black  
**Securing cables or pipes**

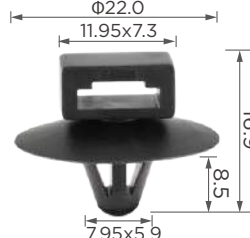

C3299

**Material:** POM  
**Color:** Black  
**Securing cables or pipes**



C3541

**Material:** PA  
**Color:** Black  
**Retainer**

## — SPECIALIZED RETAINER

### 44. Connector Holder



C3540

**Material:** PA  
**Color:** Black  
**Connector Clip**



C3649

**Material:** PA  
**Color:** Black  
**Connector Clip**



C3861

**Material:** PA  
**Color:** Natural  
**Connector Clip**



C3394

**Material:** PA  
**Color:** Black  
**Retainer**



C3579

**Material:** PA  
**Color:** Black  
**Retainer**

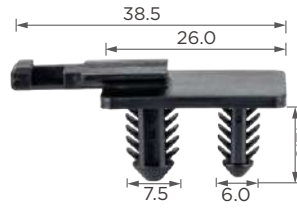

C3641

**Material:** PA  
**Color:** Black  
**Clip**



C3799

**Material:** PA  
**Color:** Black  
**Fir tree clip**

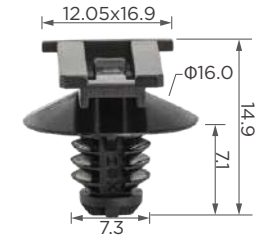

C3862

**Material:** PA  
**Color:** Black  
**Cable release**



C3832

**Material:** PA  
**Color:** Black  
**Cable holding**

### 45. Door Window Clip



C1306

**Material:** POM  
**Color:** White  
**Window regulator sliding**

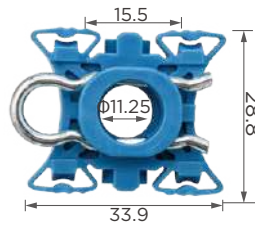

C3924

**Material:** POM  
**Color:** Blue  
**Door window**

### 46. Other Clips & Retainers

# SPECIALIZED RETAINER



**C0120**

**Material:** PA  
**Color:** Black  
**Retainer**



**C0196**

**Material:** POM  
**Color:** Black  
**Front bumper**



**C0218**

**Material:** POM  
**Color:** Black  
**Front fender, splash guard**



**C0226**

**Material:** POM  
**Color:** Brown + White  
**Side moulding**



**C0288**

**Material:** POM  
**Color:** White  
**Headlight**



**C0311**

**Material:** PA  
**Color:** Beige  
**Headlight**



**C0332**

**Material:** POM  
**Color:** Black  
**Engine**



**C0340**

**Material:** POM  
**Color:** White  
**Rear bumper**



**C0372**

**Material:** POM  
**Color:** Black  
**Retainer**

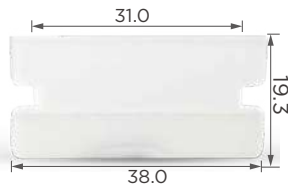

**C0499**

**Material:** POM  
**Color:** White  
**Retainer**



**C0548**

**Material:** PA  
**Color:** Green  
**Retainer**



**C0622**

**Material:** POM  
**Color:** Blue  
**Window drip moulding**

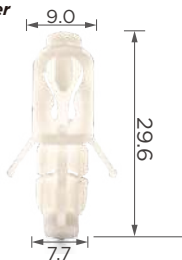

**C0668**

**Material:** POM  
**Color:** White  
**Roof**



**C0671**

**Material:** PA  
**Color:** Beige  
**Window**

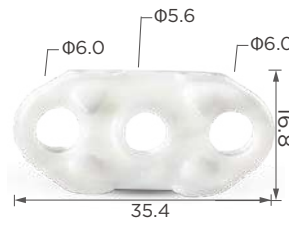

**C0694**

**Material:** POM  
**Color:** White  
**Retainer**



**C0836**

**Material:** PA + POM  
**Color:** White + Black  
**Rear bumper**



**C0849**

**Material:** PA  
**Color:** Black  
**Dashboard**

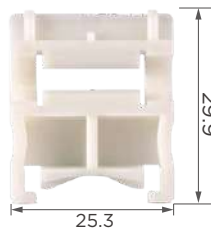

**C0851**

**Material:** POM  
**Color:** White  
**Rocker panel, sill**



**C0861**

**Material:** POM  
**Color:** White  
**Door seal**



**C0875**

**Material:** POM  
**Color:** White  
**Retainer**

## SPECIALIZED RETAINER

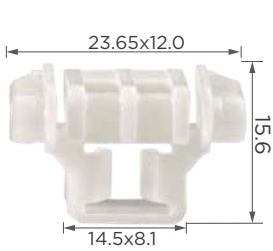

C0903

**Material:** POM  
**Color:** White  
**Outside attachment**



C0920

**Material:** POM  
**Color:** White  
**Outside attachment**



C0924

**Material:** POM  
**Color:** White  
**Side moulding**



C0927

**Material:** POM  
**Color:** Light green  
**Side moulding**



C0941

**Material:** POM  
**Color:** White  
**Side moulding, rear mirror**

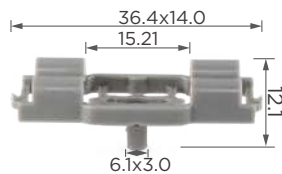

C0965

**Material:** PA  
**Color:** Grey  
**Door panel, rear bumper, hood**

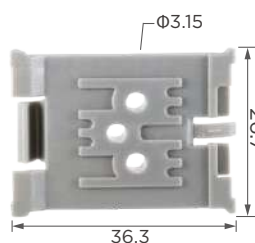

C0966

**Material:** POM  
**Color:** Grey  
**Retainer**



C0974

**Material:** POM  
**Color:** White  
**Side moulding**



C0978

**Material:** POM  
**Color:** White  
**Side moulding**



C0995

**Material:** PA  
**Color:** Black  
**Rocker panel, side moulding**



C1045

**Material:** PA  
**Color:** Natural  
**Retainer**



C1056

**Material:** POM  
**Color:** Black  
**Roof garnish**



C1087

**Material:** POM  
**Color:** White  
**Retainer**



C1102

**Material:** PA  
**Color:** White  
**Door panel**



C1105

**Material:** POM  
**Color:** White  
**Side moulding**



C1141

**Material:** PA  
**Color:** Beige  
**Radiator**



C1142

**Material:** PA  
**Color:** Black  
**Cock-water drain**



C1173

**Material:** POM  
**Color:** Red  
**Retainer**



C1180

**Material:** POM  
**Color:** White  
**Front and side door exterior**

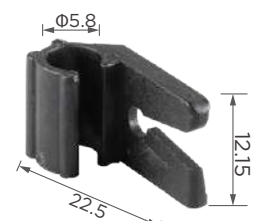

C1182

**Material:** PA  
**Color:** Black  
**Retainer**



# SPECIALIZED RETAINER

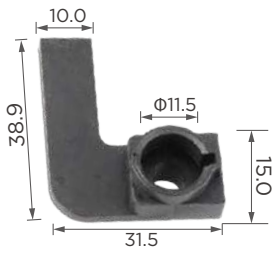

**C1196**

**Material:** PA  
**Color:** Black  
**Side moulding**



**C1247**

**Material:** PA  
**Color:** White  
**Quarter turn latches**



**C1255**

**Material:** PA  
**Color:** Black  
**Retainer**



**C1278**

**Material:** PA  
**Color:** Black  
**Front and rear bumper**

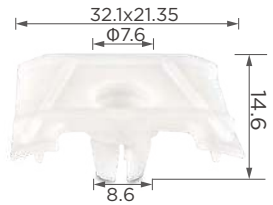

**C1282**

**Material:** POM  
**Color:** White  
**Retainer**



**C1301**

**Material:** PA  
**Color:** Milk white  
**Retainer**



**C1326**

**Material:** PA  
**Color:** White  
**Retainer**



**C1327**

**Material:** PA  
**Color:** Black  
**Side moulding**

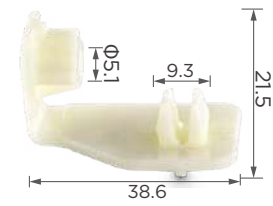

**C1328L/R**

**Material:** POM  
**Color:** White  
**Retainer**



**C1334**

**Material:** POM  
**Color:** White  
**Retainer**



**C1336**

**Material:** POM  
**Color:** Black  
**Retainer**



**C1338**

**Material:** PA  
**Color:** Black  
**Retainer**



**C1352**

**Material:** POM  
**Color:** Black  
**Windshield**



**C1381**

**Material:** POM  
**Color:** White  
**Retainer**



**C1383**

**Material:** PA  
**Color:** Black  
**Door weatherstrip**



**C1414**

**Material:** PA  
**Color:** Black  
**Gear housing, gearbox**



**C1415**

**Material:** PA  
**Color:** White  
**Retainer**



**C1431**

**Material:** POM  
**Color:** Black  
**Closing system**



**C1439**

**Material:** POM  
**Color:** White  
**Rear bumper**



**C1440**

**Material:** POM  
**Color:** White  
**Armrest, instrument panel, glove**

## SPECIALIZED RETAINER



C1441

**Material:** POM  
**Color:** White  
**Armrest, instrument panel, glove**

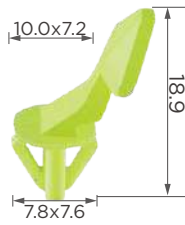

C1450

**Material:** PA  
**Color:** Bluish yellow  
**Door seal**



C1457

**Material:** PA  
**Color:** Light green  
**Side moulding**



C1463

**Material:** PA  
**Color:** Yellow  
**Door pull handle**



C1479

**Material:** PA  
**Color:** Black  
**Front and rear bumper**

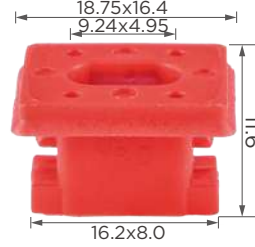

C1487

**Material:** PA  
**Color:** Red  
**Instrument panel, glove**



C1491

**Material:** POM  
**Color:** White  
**Retainer**

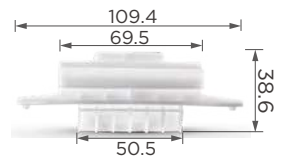

C1492

**Material:** POM  
**Color:** White  
**Retainer**



C1496

**Material:** PA  
**Color:** Black  
**Retainer**



C1516

**Material:** POM  
**Color:** Grey  
**Roof, rocker panel**



C1531

**Material:** POM  
**Color:** Black  
**Side moulding, rocker panel**



C1546

**Material:** POM  
**Color:** Black  
**Retainer**



C1560

**Material:** POM  
**Color:** Black  
**Front end panel**

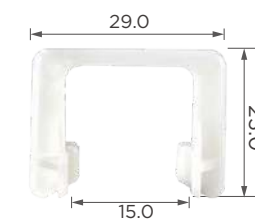

C1574

**Material:** POM  
**Color:** White  
**Door handle**



C1568

**Material:** ABS  
**Color:** Grey/ Black  
**Retainer**



C1571

**Material:** PA  
**Color:** Grey/ Black  
**Roof, seat**



C1573

**Material:** PA  
**Color:** Black  
**Door panel**



C1565

**Material:** POM  
**Color:** White  
**Channel subassy, rear door glass**



C1595

**Material:** POM  
**Color:** White  
**Retainer**



C1620

**Material:** PA  
**Color:** Black  
**Retainer**

# SPECIALIZED RETAINER



C1644

**Material:** POM  
**Color:** Black  
**Retainer**



C1651

**Material:** POM  
**Color:** White  
**Door seal**



C1657

**Material:** POM  
**Color:** White  
**Door panel**



C1662

**Material:** PA  
**Color:** Beige  
**Windshield wiper**



C1666

**Material:** POM  
**Color:** White  
**Retainer**



C1674

**Material:** POM  
**Color:** White  
**Tail light**



C1676

**Material:** PA  
**Color:** Black  
**Retainer**



C1681

**Material:** PA  
**Color:** Beige  
**Retainer**



C1696

**Material:** POM  
**Color:** Black  
**Side moulding**



C1712

**Material:** PA  
**Color:** Black  
**Wheelarch splash guard**



C1725

**Material:** POM  
**Color:** Green  
**Door panel**



C1734

**Material:** Nylon  
**Color:** Light blue  
**Side moulding, rocker panel**



C1742

**Material:** PA  
**Color:** Black  
**Front bumper grille**

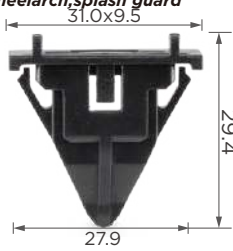

C1754

**Material:** POM  
**Color:** Black  
**Fender**



C1756

**Material:** POM  
**Color:** Yellow  
**Wheelarch, splash guard**

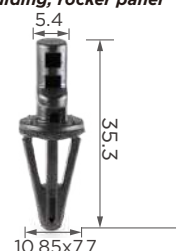

C1768

**Material:** POM  
**Color:** Black  
**Rear bumper**



C1781

**Material:** PA  
**Color:** Black  
**Door panel**



C1803

**Material:** POM  
**Color:** White  
**Side moulding**



C1809

**Material:** PA  
**Color:** Natural  
**Wheelarch, splash guard**



C1839

**Material:** PA  
**Color:** Grey  
**Side moulding, pillar**

# SPECIALIZED RETAINER



C1868

**Material:** POM  
**Color:** Black  
**Door panel**



C1871

**Material:** POM  
**Color:** Black  
**Liftgate**



C1994

**Material:** PA  
**Color:** Light green  
**Door panel**



C3041

**Material:** POM  
**Color:** White  
**Rocker panel, sill, side moulding**



C3091L/R

**Material:** POM  
**Color:** Yellow  
**Retainer**



C1878

**Material:** POM  
**Color:** Black  
**Side moulding, rocker panel**



C1984

**Material:** POM  
**Color:** Black  
**Grille**



C3010

**Material:** POM  
**Color:** White  
**Rocker panel**



C3060

**Material:** ABS  
**Color:** Black  
**Wheelarch, splash guard**



C3159

**Material:** POM  
**Color:** Black  
**Retainer**



C1885

**Material:** PA  
**Color:** Black  
**Retainer**



C1992

**Material:** POM  
**Color:** Green  
**Side moulding**



C3014

**Material:** POM  
**Color:** Black  
**Front fender**



C3072

**Material:** POM  
**Color:** White  
**Side moulding, rocker panel**



C3161

**Material:** POM  
**Color:** Grey  
**Splash guard, hood, engine cover latch, front grille**



C1925

**Material:** POM  
**Color:** Black  
**Wheelarch, splash guard**



C1993

**Material:** POM  
**Color:** White  
**Cowl**

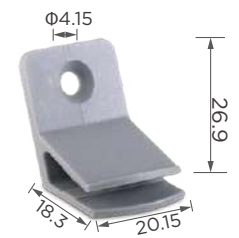

C3027

**Material:** PA  
**Color:** Grey  
**Retainer**



C3086

**Material:** PA  
**Color:** Black  
**Side moulding**



C3177

**Material:** POM  
**Color:** White  
**Door seal**

# SPECIALIZED RETAINER



C3181

**Material:** PA  
**Color:** White  
**Liftgate**



C3185

**Material:** POM  
**Color:** Black  
**Door panel**



C3189

**Material:** PA  
**Color:** Black  
**Door seal**

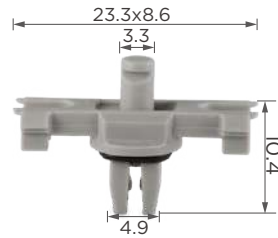

C3192

**Material:** POM  
**Color:** Grey  
**Roof, side window**

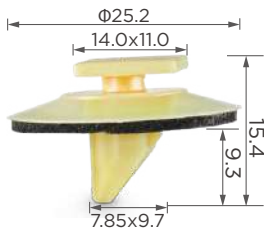

C3205

**Material:** POM  
**Color:** Yellow  
**Cowl**



C3234

**Material:** POM  
**Color:** White  
**Rear tray**



C3246

**Material:** POM  
**Color:** Grey  
**Door seal**



C3252

**Material:** POM  
**Color:** White  
**Rocker panel, sill**



C3255

**Material:** POM  
**Color:** White  
**Tube and cable holder**



C3268

**Material:** PA  
**Color:** Black+White  
**Door panel**



C3272

**Material:** POM  
**Color:** Black  
**Retainer**



C3282

**Material:** PA  
**Color:** Black  
**Retainer**



C3290

**Material:** POM  
**Color:** Black  
**Liftgate**



C3332

**Material:** POM  
**Color:** Green  
**Liftgate**



C3337

**Material:** PA  
**Color:** Black  
**Retainer**



C3351

**Material:** POM  
**Color:** Beige  
**Liftgate**



C3353

**Material:** POM  
**Color:** Natural  
**Liftgate**



C3355

**Material:** PA  
**Color:** Black  
**Liftgate**



C3379

**Material:** PA+Metal  
**Color:** Light green+ black  
**Taillight**



C3381

**Material:** POM  
**Color:** Natural  
**Rear spoiler**



# SPECIALIZED RETAINER



C3389

**Material:** PA  
**Color:** Black  
**Radiator**

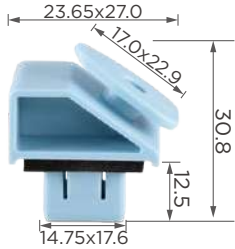

C3464

**Material:** POM  
**Color:** Light blue  
**Taillight**



C3498

**Material:** ABS  
**Color:** Grey black  
**Front air vent outlet tab**



C3592

**Material:** POM  
**Color:** Black  
**Under cover**



C3635

**Material:** POM  
**Color:** Black  
**Front & rear bumper towing cover**



C3393

**Material:** POM  
**Color:** Natural  
**Rear fender**



C3465

**Material:** POM  
**Color:** Black  
**Headlight**



C3523

**Material:** PA  
**Color:** Natural  
**Front and rear bumper**



C3603

**Material:** PA  
**Color:** Black  
**Clip**



C3637

**Material:** POM  
**Color:** Black  
**Grille**



C3432

**Material:** PP  
**Color:** Black  
**Cab assembly**



C3480

**Material:** PA  
**Color:** Black  
**Retainer**



C3554

**Material:** POM  
**Color:** Natural  
**Retainer**



C3605

**Material:** PA  
**Color:** Black  
**Retainer**



C3644

**Material:** POM  
**Color:** Natural  
**Clip**

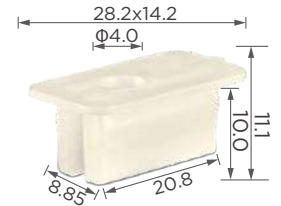

C3462

**Material:** PA  
**Color:** Natural  
**Fender**



C3481

**Material:** POM  
**Color:** Blue  
**Side moulding**



C3573

**Material:** PA  
**Color:** Black  
**Panel clip**



C3622

**Material:** POM  
**Color:** Black  
**Retainer**



C3646

**Material:** PA  
**Color:** White  
**Cowl, luggage apron**



# SPECIALIZED RETAINER

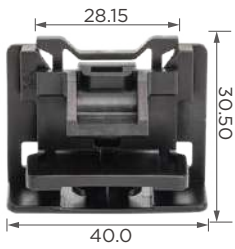

**C3671**  
**Material:** POM  
**Color:** Black  
*Rocker panel*



**C3673**  
**Material:** PA  
**Color:** Black  
*Rocker panel*



**C3676**  
**Material:** POM  
**Color:** Black  
*Drip moulding*



**C3684**  
**Material:** POM  
**Color:** Natural  
*Roof molding*



**C3685**  
**Material:** PBT  
**Color:** Black  
*Front windshield*

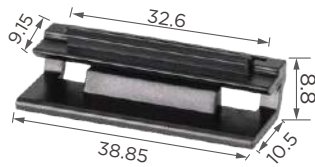

**C3691**  
**Material:** POM  
**Color:** Black  
*Front windshield glass stop*

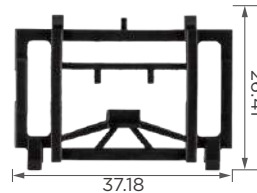

**C3698**  
**Material:** PA  
**Color:** Black  
*Retainer*



**C3716**  
**Material:** POM  
**Color:** Black  
*Rear tray, Parcel shelf fixing strap pin*



**C3748**  
**Material:** PA  
**Color:** Black  
*Grille*



**C3774**  
**Material:** POM  
**Color:** Natural  
*Front and rear bumper*



**C3777**  
**Material:** POM  
**Color:** White  
*Taillight*



**C3802**  
**Material:** PA + TPE  
**Color:** Black  
*Front liftgate, side molding*



**C3809**  
**Material:** POM  
**Color:** Natural  
*Retainer*



**C3813**  
**Material:** POM  
**Color:** Natural  
*Front bumper*

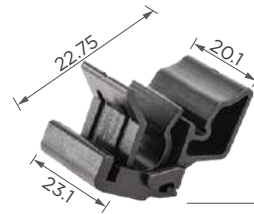

**C3828**  
**Material:** POM  
**Color:** Black  
*Front tray*



**C3833**  
**Material:** PP  
**Color:** Black  
*Rocker panel*



**C3852**  
**Material:** PA  
**Color:** Black  
*Assembly Clips*



**C3860**  
**Material:** PA  
**Color:** Natural  
*Cable release*



**C3881**  
**Material:** POM  
**Color:** White  
*Warning triangle*



**C3900**  
**Material:** POM  
**Color:** Dark blue  
*Grille, front bumper*

## SPECIALIZED RETAINER

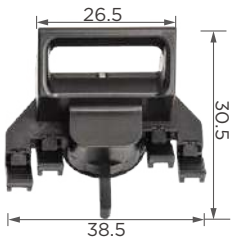

**C3905**

**Material:** POM

**Color:** Black

**Setting block and cowl**



**C3912**

**Material:** PA

**Color:** Black

**Hood insulation**



**C3925**

**Material:** PA

**Color:** Natural

**Door window**



**C3944**

**Material:** POM

**Color:** Natural

**Cowl**



**C3958**

**Material:** POM

**Color:** Natural

**Side molding**

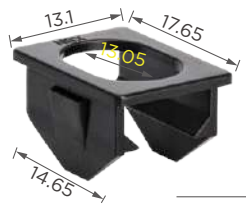

**C3984**

**Material:** POM

**Color:** Black

**Rear quarter trim panel, headlight**



**C4031**

**Material:** PA

**Color:** Beige

**Fuel line**

# METAL SCREW & BOLT

**Product No.:** H2254

**Head style:** Trox truss  
**Position:** Fender, dashboard  
**Metric:** M5

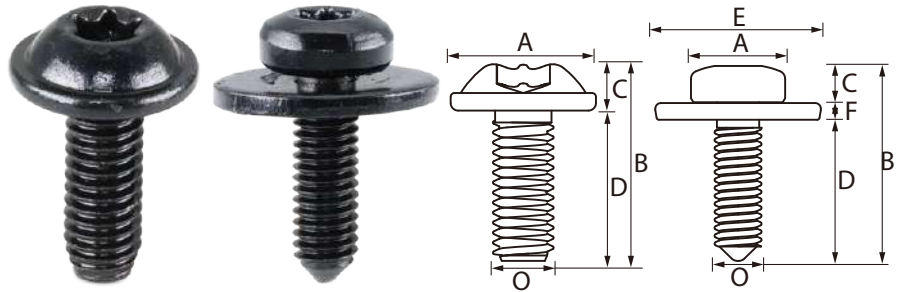

Product Details

Part No.	Metric	Threads	Pitch	mm							inch						
									Washer							Washer	
				O	A	B	C	D	E	F	O	A	B	C	D	E	F
H2321	X	7	1.80	4.00	8.80	16.60	2.40	14.20	X	X	0.156	0.343	0.647	0.094	0.554	X	X
H2267	X	6	1.80	4.10	7.90	14.35	2.75	11.60	X	X	0.160	0.308	0.560	0.107	0.452	X	X
H2373	X	10	1.45	4.10	8.80	18.90	3.00	15.90	X	X	0.160	0.343	0.737	0.117	0.620	X	X
H2272	X	6	1.80	4.10	11.20	14.75	2.75	12.00	X	X	0.160	0.437	0.575	0.107	0.468	X	X
H2287	X	6	1.45	4.10	11.80	13.05	3.10	9.95	X	X	0.160	0.460	0.509	0.121	0.388	X	X
H2268	X	12	1.35	4.15	11.75	19.00	2.90	16.10	X	X	0.162	0.458	0.741	0.113	0.628	X	X
H2288	X	8	1.45	4.15	7.85	14.50	3.00	11.50	11.80	1.00	0.162	0.306	0.566	0.117	0.449	0.460	0.039
H2264	X	9	1.40	4.20	11.55	15.95	3.00	12.95	X	X	0.164	0.450	0.622	0.117	0.505	X	X
H2372	X	17	1.40	4.20	9.70	27.50	2.90	24.60	X	X	0.164	0.378	1.073	0.113	0.959	X	X
H2330	X	12	1.50	4.20	9.30	21.60	2.70	18.90	X	X	0.164	0.363	0.842	0.105	0.737	X	X
H2349	X	9	1.60	4.70	13.90	19.15	3.45	15.70	X	X	0.183	0.542	0.747	0.135	0.612	X	X
H2397	X	8	2.00	4.40	15.80	22.75	2.75	20.00	X	X	0.172	0.616	0.887	0.107	0.780	X	X
H2096	X	11	1.60	4.79	14.50	21.90	3.50	18.40	X	X	0.187	0.566	0.854	0.137	0.718	X	X
H2126	X	9	1.55	4.80	14.80	19.59	3.29	16.30	X	X	0.187	0.577	0.764	0.128	0.636	X	X
H2252	X	9	1.60	4.80	14.80	19.10	3.15	15.95	X	X	0.187	0.577	0.745	0.123	0.622	X	X
H2182	X	6	2.00	4.90	14.30	19.20	3.50	15.70	X	X	0.191	0.558	0.749	0.137	0.612	X	X
H2250	M5	19	0.80	4.90	11.05	20.90	4.95	15.95	X	X	0.191	0.431	0.815	0.193	0.622	X	X
H2254	M5	13	0.80	4.90	11.60	15.70	3.70	12.00	X	X	0.191	0.452	0.612	0.144	0.468	X	X
H2095	X	8	2.16	4.99	11.80	24.30	4.80	17.85	20.00	1.65	0.195	0.460	0.948	0.187	0.696	0.780	0.064
H2189	X	8	2.40	5.00	9.60	28.00	3.50	22.50	16.00	2.00	0.195	0.374	1.092	0.137	0.878	0.624	0.078
H2265	X	7	2.15	5.05	12.25	18.80	3.10	15.70	X	X	0.197	0.478	0.733	0.121	0.612	X	X
H2070	X	6	2.20	5.10	7.95	16.00	3.00	11.35	14.85	1.65	0.199	0.310	0.624	0.117	0.443	0.579	0.064
H2328	X	7	2.25	5.10	7.97	22.50	2.85	18.05	17.90	1.60	0.199	0.311	0.878	0.111	0.704	0.698	0.062
H2263	X	9	2.25	5.10	11.75	25.10	2.95	22.10	X	X	0.199	0.458	0.979	0.115	0.862	X	X
H2381	X	9	1.80	5.10	10.65	19.50	3.50	16.00	X	X	0.199	0.415	0.761	0.137	0.624	X	X
H2266	X	4	2.10	5.10	11.80	15.45	3.40	12.15	X	X	0.199	0.460	0.603	0.133	0.474	X	X
H2311	X	6	2.10	5.10	10.80	19.00	3.20	15.80	X	X	0.199	0.421	0.741	0.125	0.616	X	X
H2273	X	6	2.20	5.15	9.85	18.80	3.00	15.80	X	X	0.201	0.384	0.733	0.117	0.616	X	X

## METAL SCREW & BOLT

Part No.	Metric	Threads	Pitch	mm								inch							
									Washer								Washer		
				O	A	B	C	D	E	F	O	A	B	C	D	E	F		
H2274	X	6	2.20	5.15	12.05	17.40	3.40	14.00	X	X	0.201	0.470	0.679	0.133	0.546	X	X		
H2094	X	8	2.20	5.18	14.60	22.78	3.15	19.63	X	X	0.202	0.569	0.888	0.123	0.766	X	X		
H2262	M6	20	1.00	5.80	14.15	29.40	4.50	24.90	X	X	0.226	0.552	1.147	0.176	0.971	X	X		
H2270	M6	11	0.98	5.80	15.15	19.30	5.00	14.30	X	X	0.226	0.591	0.753	0.195	0.558	X	X		
H2271	M6	9	1.00	5.80	16.85	16.70	4.50	12.20	X	X	0.226	0.657	0.651	0.176	0.476	X	X		
H2269	M6	10	1.00	5.85	14.35	16.35	4.55	11.80	X	X	0.228	0.560	0.638	0.177	0.460	X	X		
H2326	M6	16	1.00	5.85	14.40	19.90	4.10	15.80	X	X	0.228	0.562	0.776	0.160	0.616	X	X		
H2399	M6	12	1.00	5.85	13.20	19.50	3.62	15.88	X	X	0.228	0.515	0.761	0.141	0.619	X	X		
H2334	M6	15	1.00	5.89	19.20	23.80	3.75	20.05	X	X	0.230	0.749	0.928	0.146	0.782	X	X		
H2117	M6	17	0.89	5.90	11.90	28.60	4.70	22.00	13.90	1.60	0.230	0.464	1.115	0.183	0.858	0.542	0.062		
H2259	M6	20	1.00	5.90	12.00	29.55	4.55	22.95	20.85	2.05	0.230	0.468	1.152	0.177	0.895	0.813	0.080		
H2276	M6	15	1.00	5.90	19.10	19.80	3.80	15.90	X	X	0.230	0.745	0.772	0.148	0.620	X	X		
H2289	M6	15	1.00	5.90	11.80	24.45	4.55	17.85	20.75	2.05	0.230	0.460	0.954	0.177	0.696	0.809	0.080		
H2290	M6	14	1.00	5.90	11.90	22.50	4.60	15.90	23.90	2.00	0.230	0.464	0.878	0.179	0.620	0.932	0.078		
H2348	X	8	2.60	5.90	14.85	26.05	3.00	23.05	X	X	0.230	0.579	1.016	0.117	0.899	X	X		
H2256	X	59	1.00	6.00	17.10	66.70	4.50	62.20	X	X	0.234	0.667	2.601	0.176	2.426	X	X		
H2335	M6	15	1.00	6.00	15.90	21.30	3.50	17.80	X	X	0.234	0.620	0.831	0.137	0.694	X	X		
H2325	X	6	2.70	6.10	11.80	23.50	3.50	17.70	14.85	1.55	0.238	0.460	0.917	0.137	0.690	0.579	0.060		
H2313	X	8	2.70	6.10	17.60	27.30	4.30	23.00	X	X	0.238	0.686	1.065	0.168	0.897	X	X		
H2363	X	7	1.85	6.20	17.70	17.45	3.30	14.15	X	X	0.242	0.690	0.681	0.129	0.552	X	X		
H2257	X	6	3.15	7.00	19.80	26.15	4.30	21.85	X	X	0.273	0.772	1.020	0.168	0.852	X	X		

**Product No.:** H2109

**Head style:** Phillips hexagon washer

**Position:** Genuine screw

**Metric:** M6

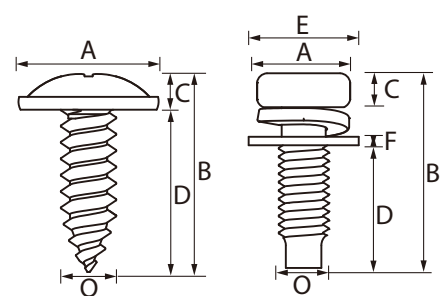

Product Details

## METAL SCREW & BOLT

Part No.	Metric	Threads	Pitch	mm							inch						
									Washer							Washer	
				O	A	B	C	D	E	F	O	A	B	C	D	E	F
H2057	M4	9	0.58	4.00	7.0x7.8	10.90	3.10	7.80	X	X	0.156	0.273x0.304	0.425	0.121	0.304	X	X
H2327	X	7	1.30	4.00	9.80	12.85	2.70	10.15	X	X	0.156	0.382	0.501	0.105	0.396	X	X
H2054	X	9	1.60	4.09	8.00	17.36	2.16	15.20	X	X	0.160	0.312	0.677	0.084	0.593	X	X
H2227	X	21	1.40	4.10	10.15	34.70	2.85	31.85	X	X	0.160	0.396	1.353	0.111	1.242	X	X
H2228	X	12	1.40	4.10	12.15	21.80	2.90	18.90	X	X	0.160	0.474	0.850	0.113	0.737	X	X
H2229	X	23	1.50	4.10	10.15	40.20	2.90	37.30	X	X	0.160	0.396	1.568	0.113	1.455	X	X
H2336	X	7	1.30	4.10	12.10	16.05	2.95	13.10	X	X	0.160	0.472	0.626	0.115	0.511	X	X
H2226	X	12	1.50	4.15	10.15	21.80	2.85	18.95	X	X	0.162	0.396	0.850	0.111	0.739	X	X
H2236	X	12	1.40	4.15	8.00	21.75	2.85	17.90	12.00	1.00	0.162	0.312	0.848	0.111	0.698	0.468	0.039
H2261	X	10	1.80	4.15	6.75	22.80	2.50	20.30	X	X	0.162	0.263	0.889	0.098	0.792	X	X
H2347	X	7	1.60	4.15	9.20	14.40	2.50	11.90	X	X	0.162	0.359	0.562	0.098	0.464	X	X
H2041	X	13	1.41	4.19	10.00	22.20	2.90	19.30	X	X	0.163	0.390	0.866	0.113	0.753	X	X
H2014	X	8	1.45	4.20	8.00	14.30	2.30	12.10	X	X	0.164	0.312	0.558	0.090	0.472	X	X
H2177	X	11	1.30	4.20	8.00	21.50	2.90	16.90	14.80	1.70	0.164	0.312	0.839	0.113	0.659	0.577	0.066
H2370	X	10	1.60	4.65	11.25	21.95	2.65	19.30	X	X	0.181	0.439	0.856	0.103	0.753	X	X
H2258	X	3	1.60	4.70	9.40	9.60	3.60	6.00	X	X	0.183	0.367	0.374	0.140	0.234	X	X
H2352	X	8	1.60	4.70	9.20	19.30	3.50	15.80	18.00	1.65	0.183	0.359	0.753	0.137	0.616	0.702	0.064
H2368	X	9	1.60	4.75	9.40	19.20	3.55	15.65	X	X	0.185	0.367	0.749	0.138	0.610	X	X
H2033	X	8	1.70	4.78	9.41	21.71	3.21	17.20	15.10	1.30	0.186	0.367	0.847	0.125	0.671	0.589	0.051
H2058	M5	10	0.80	4.80	8.0x8.7	11.10	3.35	7.75	X	X	0.187	0.312x0.339	0.433	0.131	0.302	X	X
H2065	X	8	1.60	4.80	11.50	15.21	3.11	12.10	X	X	0.187	0.449	0.593	0.121	0.472	X	X
H2069	X	10	1.59	4.89	15.95	21.86	3.11	17.35	X	X	0.191	0.622	0.853	0.121	0.677	X	X
H2190	M5	16	0.80	4.90	7.80	23.30	3.35	18.90	15.90	1.05	0.191	0.304	0.909	0.131	0.737	0.620	0.041
H2383	X	9	1.58	4.90	14.10	18.72	3.22	15.50	X	X	0.191	0.550	0.730	0.126	0.605	X	X
H2055	X	7	2.15	4.99	10.00	19.09	2.94	16.15	X	X	0.195	0.390	0.745	0.115	0.630	X	X
H2081	X	8	1.50	5.00	14.20	17.20	3.15	14.05	X	X	0.195	0.554	0.671	0.123	0.548	X	X
H2175	X	8	1.60	5.00	7.9x8.85	19.30	3.50	14.80	16.00	1.00	0.195	0.308x0.345	0.753	0.137	0.577	0.624	0.039
H2192	X	12	1.59	5.00	7.95x9.1	23.40	3.50	18.70	15.80	1.20	0.195	0.310x0.355	0.913	0.137	0.729	0.616	0.047
H2369	X	5	1.80	5.00	10.60	16.70	3.30	13.40	X	X	0.195	0.413	0.651	0.129	0.523	X	X
H2345	X	7	1.55	5.00	12.50	16.25	3.70	12.55	X	X	0.195	0.488	0.634	0.144	0.489	X	X
H2193	X	9	1.63	5.00	12.80	19.60	3.60	16.00	X	X	0.195	0.499	0.764	0.140	0.624	X	X
H2195	X	14	1.40	5.00	14.25	23.30	3.20	20.10	X	X	0.195	0.556	0.909	0.125	0.784	X	X
H2339	X	9	1.80	5.00	12.65	22.15	1.85	20.30	X	X	0.195	0.493	0.864	0.072	0.792	X	X
H2019	X	9	2.12	5.10	9.9x11.1	25.95	4.25	20.20	17.80	1.50	0.199	0.386x0.433	1.012	0.166	0.788	0.694	0.059
H2053	X	10	1.80	5.10	10.60	22.80	3.25	19.55	X	X	0.199	0.413	0.889	0.127	0.762	X	X
H2064	X	6	2.10	5.10	11.50	16.00	3.70	12.30	X	X	0.199	0.449	0.624	0.144	0.480	X	X
H2231	X	9	1.83	5.10	13.40	22.69	2.89	19.80	X	X	0.199	0.523	0.885	0.113	0.772	X	X
H2310	X	7	2.30	5.10	15.80	22.00	3.80	18.20	X	X	0.199	0.616	0.858	0.148	0.710	X	X
H2316	X	7	2.30	5.10	10.00	20.10	3.69	16.41	X	X	0.199	0.390	0.784	0.144	0.640	X	X
H2318	X	3	2.20	5.10	9.85	11.10	3.50	7.60	X	X	0.199	0.384	0.433	0.137	0.296	X	X
H2133	X	8	2.15	5.14	9.85x11.2	25.78	4.28	20.50	13.90	1.00	0.200	0.384x0.437	1.005	0.167	0.800	0.542	0.039
H2346	X	5	2.10	5.15	11.35	15.20	3.00	12.20	X	X	0.201	0.443	0.593	0.117	0.476	X	X
H2093	X	9	2.26	5.19	14.80	24.00	3.50	20.50	X	X	0.202	0.577	0.936	0.137	0.800	X	X

## METAL SCREW & BOLT

Part No.	Metric	Threads	Pitch	mm							inch						
									Washer							Washer	
				O	A	B	C	D	E	F	O	A	B	C	D	E	F
H2136	X	8	2.13	5.20	7.8x8.8	23.31	3.26	19.05	11.80	1.00	0.203	0.304x0.343	0.909	0.127	0.743	0.460	0.039
H2371	X	7	1.80	5.35	8.95	22.75	5.30	17.45	15.60	1.50	2.199	2.310	2.780	2.055	2.601	2.850	2.062
H2168	X	8	1.75	5.39	13.00	22.26	3.18	19.08	X	X	0.210	0.507	0.868	0.124	0.744	X	X
H2066	X	8	1.91	5.89	9.85x11.0	23.50	4.30	18.20	12.95	1.00	0.230	0.384x0.429	0.917	0.168	0.710	0.505	0.039
H2062	M6	10	1.00	5.90	9.9x11.03	20.10	4.40	15.70	X	X	0.230	0.386x0.430	0.784	0.172	0.612	X	X
H2109	M6	11	1.00	5.90	9.8x11.0	23.00	4.00	14.30	13.00	1.00	0.230	0.382x0.429	0.897	0.156	0.558	0.507	0.039
H2110	M6	8	1.00	5.90	9.7x11.0	20.20	4.00	11.70	13.00	1.00	0.230	0.378x0.429	0.788	0.156	0.456	0.507	0.039
H2355	X	13	1.80	5.90	16.00	28.80	3.60	25.20	X	X	0.230	0.624	1.123	0.140	0.983	X	X
H2178	M6	14	1.00	5.95	9.85x11.2	23.90	4.15	16.70	16.85	3.05	0.232	0.384x0.437	0.932	0.162	0.651	0.657	0.119
H2067	X	6	2.53	5.99	9.95x11.2	21.90	4.40	16.45	17.90	1.05	0.234	0.388x0.437	0.854	0.172	0.642	0.698	0.041
H2340	X	6	1.80	6.00	10.0x11.2	19.35	4.05	13.70	17.90	1.60	0.234	0.390x0.437	0.755	0.158	0.534	0.698	0.062
H2039	X	8	0.74	6.04	10.90	20.41	3.06	16.15	15.95	1.00	0.236	0.425	0.796	0.119	0.630	0.622	0.039
H2110	M6	8	1.00	5.90	9.7x11.0	20.20	4.00	11.70	13.00	1.00	0.230	0.378x0.429	0.788	0.156	0.456	0.507	0.039
H2355	X	13	1.80	5.90	16.00	28.80	3.60	25.20	X	X	0.230	0.624	1.123	0.140	0.983	X	X
H2178	M6	14	1.00	5.95	9.85x11.2	23.90	4.15	16.70	16.85	3.05	0.232	0.384x0.437	0.932	0.162	0.651	0.657	0.119
H2067	X	6	2.53	5.99	9.95x11.2	21.90	4.40	16.45	17.90	1.05	0.234	0.388x0.437	0.854	0.172	0.642	0.698	0.041
H2340	X	6	1.80	6.00	10.0x11.2	19.35	4.05	13.70	17.90	1.60	0.234	0.390x0.437	0.755	0.158	0.534	0.698	0.062
H2039	X	8	0.74	6.04	10.90	20.41	3.06	16.15	15.95	1.00	0.236	0.425	0.796	0.119	0.630	0.622	0.039
H2232	X	8	1.60	6.05	13.80	18.50	3.35	15.15	X	X	0.236	0.538	0.722	0.131	0.591	X	X
H2007	X	8	2.50	6.08	9.85x11.1	27.30	4.20	22.05	17.90	1.05	0.237	0.384x0.433	1.065	0.164	0.860	0.698	0.041
H2020	X	6	2.42	6.09	15.60	19.84	2.74	17.10	X	X	0.238	0.608	0.774	0.107	0.667	X	X
H2167	X	8	1.80	6.10	9.9x11.2	22.90	5.10	17.80	X	X	0.238	0.386x0.437	0.893	0.199	0.694	X	X
H2008	X	7	2.55	6.18	9.8x11.2	25.50	4.30	19.70	19.80	1.50	0.241	0.382x0.437	0.995	0.168	0.768	0.772	0.059
H2031	X	8	2.53	6.18	9.80	30.10	5.10	24.00	15.90	1.00	0.241	0.382	1.174	0.199	0.936	0.620	0.039
H2056	X	6	2.64	6.18	11.90	20.14	3.34	16.80	X	X	0.241	0.464	0.785	0.130	0.655	X	X
H2009	X	6	2.46	6.19	9.85x11.1	22.50	4.45	17.05	16.00	1.00	0.241	0.384x0.433	0.878	0.174	0.665	0.624	0.039
H2021	X	7	2.55	6.19	9.8x11.1	27.70	4.20	22.00	20.00	1.50	0.241	0.382x0.433	1.080	0.164	0.858	0.780	0.059
H2152	X	5	2.60	6.19	9.8x11.2	20.95	4.20	15.75	13.85	1.00	0.241	0.382x0.437	0.817	0.164	0.614	0.540	0.039
H2131	X	9	2.52	6.20	9.8x11.1	30.40	5.10	23.70	15.95	1.10	0.242	0.382x0.433	1.186	0.199	0.924	0.622	0.043
H2338	X	9	1.80	6.20	9.9x11.15	24.45	4.30	18.55	15.85	1.60	0.242	0.386x0.435	0.954	0.168	0.723	0.618	0.062
H2180	X	9	1.85	6.29	15.85	22.40	4.60	17.80	X	X	0.245	0.618	0.874	0.179	0.694	X	X
H2077	X	8	1.90	6.30	15.60	19.25	2.65	16.60	X	X	0.246	0.608	0.751	0.103	0.647	X	X
H2130	X	6	2.63	6.30	9.85x11.2	24.10	4.30	18.20	20.00	1.60	0.246	0.384x0.437	0.940	0.168	0.710	0.780	0.062
H2135	X	6	2.49	6.30	9.7x11.0	21.20	4.40	15.80	15.90	1.00	0.246	0.378x0.429	0.827	0.172	0.616	0.620	0.039
H2181	X	13	1.80	6.38	15.90	28.35	3.80	24.55	X	X	0.249	0.620	1.106	0.148	0.957	X	X



# METAL SCREW & BOLT

**Product No.:** H2071

**Head style:** Full-bearing hexagon washer

**Position:** Front bumper

**Metric:** M8



Product Details

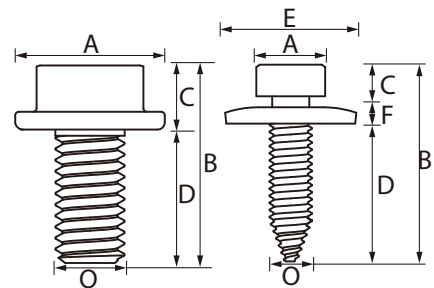

Part No.	Metric	Washer	Threads	Pitch	mm							inch										
												Washer									Washer	
					O	A	B	C	D	E	F	O	A	B	C	D	E	F				
H2240	X	√	14	1.40	4.20	5.45x6.2	24.70	3.00	20.50	15.65	1.20	0.164	0.213x0.242	0.963	0.117	0.800	0.610	0.047				
H2040	X	√	13	1.40	4.30	6.65x7.45	22.85	2.85	18.95	16.00	1.05	0.168	0.259x0.291	0.891	0.111	0.739	0.624	0.041				
H2332	X	√	8	1.60	4.70	7.8x8.7	18.70	3.30	13.90	14.90	1.50	0.183	0.304x0.339	0.729	0.129	0.542	0.581	0.059				
H2366	X	√	9	1.60	4.75	7.95	22.40	5.00	17.40	17.90	1.60	1.199	1.310	1.780	1.055	1.601	1.850	1.062				
H2116	X	√	8	1.60	4.79	7.80	18.80	3.20	14.00	17.80	1.60	0.187	0.304	0.733	0.125	0.546	0.694	0.062				
H2037	X	√	10	1.60	4.80	7.9x8.65	24.50	4.90	17.50	25.80	2.10	0.187	0.308x0.337	0.956	0.191	0.683	1.006	0.082				
H2038	X	√	8	1.59	4.89	7.8x8.75	18.50	3.15	13.85	17.90	1.50	0.191	0.304x0.341	0.722	0.123	0.540	0.698	0.059				
H2105	M5	√	20	0.80	4.89	7.8x8.65	26.40	4.00	21.40	17.80	1.00	0.191	0.304x0.337	1.030	0.156	0.835	0.694	0.039				
H2112	M5	√	19	0.80	4.89	8.8x7.9	25.10	3.60	20.45	17.90	1.05	0.191	0.343x0.308	0.979	0.140	0.798	0.698	0.041				
H2173	X	√	9	1.60	4.89	7.8x8.85	19.52	3.14	15.38	9.60	1.00	0.191	0.304x0.345	0.761	0.122	0.600	0.374	0.039				
H2082	M5	√	14	0.80	4.90	9.8x11.1	17.90	4.00	12.40	15.70	1.00	0.191	0.382x0.433	0.698	0.156	0.484	0.612	0.039				
H2085	M5	√	18	0.80	4.90	7.85x8.85	23.90	3.50	18.30	12.40	2.10	0.191	0.306x0.345	0.932	0.137	0.714	0.484	0.082				
H2317	X	√	17	1.00	4.90	10.00	25.70	5.90	19.80	13.70	1.60	0.191	0.390	1.002	0.230	0.772	0.534	0.062				
H2329	X	√	5	2.20	5.00	9.00	18.80	4.60	14.50	17.90	1.60	0.195	0.351	0.733	0.179	0.566	0.698	0.062				
H2304	X	√	7	2.20	5.05	9.0x7.95	22.70	3.10	18.00	21.90	1.60	0.197	0.351x0.310	0.885	0.121	0.702	0.854	0.062				
H2333	X	√	6	2.30	5.10	8.95x7.95	20.75	3.00	16.15	15.90	1.60	0.199	0.349x0.310	0.809	0.117	0.630	0.620	0.062				
H2358	X	√	6	2.20	5.10	7.95	20.00	1.40	15.40	21.80	1.60	0.199	0.310	0.780	0.055	0.601	0.850	0.062				
H2394	X	√	6	2.25	5.10	9.90	17.80	2.80	13.55	22.10	1.45	0.199	0.386	0.694	0.109	0.528	0.862	0.057				
H2123	X	√	9	1.76	5.34	7.8x8.8	22.00	3.40	17.00	15.00	1.60	0.208	0.304x0.343	0.858	0.133	0.663	0.585	0.062				
H2108	X	√	8	1.81	5.39	8.8x7.85	23.00	3.50	18.00	15.05	1.50	0.210	0.343x0.306	0.897	0.137	0.702	0.587	0.059				
H2063	M6	√	7	1.00	5.80	10.0x11.2	20.20	4.10	16.10	X	X	0.226	0.390x0.437	0.788	0.160	0.628	X	X				
H2074	M6	√	16	1.00	5.89	9.8x11.0	24.60	4.20	17.50	16.85	2.90	0.230	0.382x0.429	0.959	0.164	0.683	0.657	0.113				
H2075	M6	√	20	1.00	5.89	9.9x11.12	28.30	4.10	21.10	24.00	3.10	0.230	0.386x0.434	1.104	0.160	0.823	0.936	0.121				
H2103	M6	√	17	1.00	5.89	9.8x10.9	29.20	4.00	23.20	20.00	2.00	0.230	0.382x0.425	1.139	0.156	0.905	0.780	0.078				
H2104	M6	√	17	1.00	5.89	9.8x10.9	29.20	4.00	23.20	20.00	2.00	0.230	0.382x0.425	1.139	0.156	0.905	0.780	0.078				
H2134	M6	X	9	1.00	5.89	15.50	17.40	6.35	11.05	X	X	0.230	0.605	0.679	0.248	0.431	X	X				
H2005	X	√	17	1.00	5.90	9.85x11.0	24.00	5.60	18.00	19.90	1.13	0.230	0.384x0.429	0.936	0.218	0.702	0.776	0.044				
H2034	M6	√	17	1.00	5.90	9.85x10.9	23.80	4.20	17.70	20.00	1.90	0.230	0.384x0.425	0.928	0.164	0.690	0.780	0.074				
H2059	M6	X	11	1.00	5.90	13.40	17.70	5.70	12.00	X	X	0.230	0.523	0.690	0.222	0.468	X	X				
H2073	M6	√	20	1.00	5.90	9.9x11.1	27.40	4.10	20.50	16.85	2.80	0.230	0.386x0.433	1.069	0.160	0.800	0.657	0.109				

## METAL SCREW & BOLT

Part No.	Metric	Washer	Threads	Pitch	mm							inch						
										Washer							Washer	
					O	A	B	C	D	E	F	O	A	B	C	D	E	F
H2084	M6	√	30	1.00	5.90	9.9x11.1	38.50	4.15	31.35	16.90	3.00	0.230	0.386x0.433	1.502	0.162	1.223	0.659	0.117
H2086	M6	√	17	1.00	5.90	9.70	33.90	4.00	18.20	19.70	1.55	0.230	0.378	1.322	0.156	0.710	0.768	0.060
H2107	M6	√	10	1.00	5.90	9.8x10.95	21.90	4.00	16.30	17.85	1.60	0.230	0.382x0.427	0.854	0.156	0.636	0.696	0.062
H2111	M6	√	19	1.00	5.90	9.8x11.0	33.10	4.10	24.50	13.00	1.00	0.230	0.382x0.429	1.291	0.160	0.956	0.507	0.039
H2174	M6	√	13	1.00	6.00	9.9x11.43	21.30	5.90	14.35	17.90	1.05	0.234	0.308x0.446	0.831	0.230	0.560	0.698	0.041
H2331	M6	√	12	1.00	6.00	10.00	23.80	5.30	17.70	17.90	1.60	0.234	0.390	0.928	0.207	0.690	0.698	0.062
H2187	X	√	5	2.60	6.10	9.90	20.40	4.15	15.20	20.00	1.05	0.238	0.386	0.796	0.162	0.593	0.780	0.041
H2230	X	X	10	1.75	6.10	12.40	24.65	5.60	19.05	X	X	0.238	0.484	0.961	0.218	0.743	X	X
H2253	M6	√	9	1.00	6.10	9.85x11.0	16.00	4.05	10.25	17.90	1.70	0.238	0.384x0.429	0.624	0.158	0.400	0.698	0.066
H2235	X	√	6	1.90	6.15	9.9x11.2	20.10	4.50	14.20	16.80	1.40	0.240	0.386x0.437	0.784	0.176	0.554	0.655	0.055
H2124	X	√	9	1.84	6.18	9.9x11.1	24.90	4.20	19.20	17.85	1.50	0.241	0.386x0.433	0.971	0.164	0.749	0.696	0.059
H2076	X	√	9	1.84	6.19	10.3x11.89	25.70	5.40	18.90	16.80	1.40	0.241	0.402x0.464	1.002	0.211	0.737	0.655	0.055
H2210	X	√	14	1.30	6.20	10.9x12.4	29.50	4.65	22.65	15.85	2.20	0.242	0.425x0.483	1.151	0.181	0.883	0.618	0.086
H2238	X	√	10	1.55	6.20	9.85x11.2	25.00	4.80	18.60	17.85	1.60	0.242	0.384x0.437	0.975	0.187	0.725	0.696	0.062
H2211	X	√	11	1.30	6.30	11.0x12.35	26.45	4.60	19.35	19.00	2.50	0.246	0.429x0.482	1.032	0.179	0.755	0.741	0.098
H2218	X	X	12	1.30	6.30	12.80	24.40	5.80	18.60	X	X	0.246	0.499	0.952	0.226	0.725	X	X
H2353	X	√	6	2.60	6.50	9.80	24.90	6.40	18.50	18.00	2.00	0.254	0.382	0.971	0.250	0.722	0.702	0.078
H2061	M8	√	10	1.25	7.80	11.70	20.60	5.90	14.70	X	X	0.304	0.456	0.803	0.230	0.573	X	X
H2379	X	X	15	1.24	7.80	11.90	27.20	7.20	20.00	X	X	0.304	0.464	1.061	0.281	0.780	X	X
H2071	M8	√	19	1.25	7.80	12.6x14.24	36.00	5.80	27.20	24.00	3.00	0.304	0.491x0.555	1.404	0.226	1.061	0.936	0.117
H2072	M8	X	11	1.24	7.80	16.90	22.20	7.20	15.00	X	X	0.304	0.659	0.866	0.281	0.585	X	X
H2106	M8	√	14	1.22	7.80	11.8x13.3	30.40	5.50	17.80	17.80	1.60	0.304	0.460x0.519	1.186	0.215	0.694	0.694	0.062
H2208	X	X	17	1.40	7.80	16.40	31.80	6.90	24.90	X	X	0.304	0.640	1.240	0.269	0.971	X	X
H2213	X	X	12	1.40	7.80	20.50	33.00	8.00	25.00	X	X	0.304	0.800	1.287	0.312	0.975	X	X
H2237	X	√	14	1.40	7.85	12.60	30.60	5.60	21.65	22.50	3.35	0.306	0.491	1.193	0.218	0.844	0.878	0.131
H2087	M8	X	13	1.23	7.89	12.95	24.00	7.90	16.10	X	X	0.308	0.505	0.936	0.308	0.628	X	X
H2083	M8	√	16	1.25	7.90	12.6x14.2	30.40	5.70	21.70	24.00	3.00	0.308	0.491x0.554	1.186	0.222	0.846	0.936	0.117
H2206	X	√	17	1.25	7.90	12.7x14.25	30.85	5.70	21.65	22.20	3.50	0.308	0.495x0.556	1.203	0.222	0.844	0.866	0.137
H2209	X	√	30	1.00	7.90	12.8x14.4	41.15	5.75	31.90	23.80	3.50	0.308	0.499x0.562	1.605	0.224	1.244	0.928	0.137
H2212	X	√	12	1.40	7.90	12.6x14.1	32.65	5.60	23.75	22.30	3.30	0.308	0.491x0.550	1.273	0.218	0.926	0.870	0.129
H2214	M8	√	20	1.20	7.90	9.85x11.1	38.20	5.95	28.75	22.30	3.50	0.308	0.384x0.433	1.490	0.232	1.121	0.870	0.137
H2215	M8	X	19	1.25	7.90	12.85x14.8	31.70	6.95	24.75	X	X	0.308	0.501x0.577	1.236	0.271	0.965	X	X
H2216	X	X	14	1.30	7.90	16.50	26.60	6.75	19.85	X	X	0.308	0.644	1.037	0.263	0.774	X	X
H2217	X	X	13	1.35	7.90	16.40	25.60	6.80	18.80	X	X	0.308	0.640	0.998	0.265	0.733	X	X
H2205	X	√	26	1.45	8.00	14.9x16.8	51.45	7.35	40.45	29.70	3.65	0.312	0.581x0.655	2.007	0.287	1.578	1.158	0.142
H2141	M10	X	5	1.44	9.79	18.40	15.10	6.50	8.60	X	X	0.382	0.718	0.589	0.254	0.335	X	X
H2142	M10	X	4	1.50	9.79	18.20	14.00	5.25	8.75	X	X	0.382	0.710	0.546	0.205	0.341	X	X
H2378	X	X	17	1.30	9.80	13.86	42.05	9.22	32.83	X	X	0.382	0.541	1.640	0.360	1.280	X	X
H2060	X	X	17	1.10	9.80	19.60	34.05	9.23	24.82	X	X	0.382	0.764	1.328	0.360	0.968	X	X
H2113	X	√	17	1.00	9.90	13.9x15.3	37.20	6.90	22.80	21.85	1.60	0.386	0.542x0.597	1.451	0.269	0.889	0.852	0.062
H2207	M10	√	18	1.40	9.90	14.90	37.70	7.30	26.90	27.70	3.40	0.386	0.581	1.470	0.285	1.049	1.080	0.133
H2132	X	√	12	1.30	11.00	13.95x16.02	28.80	12.70	16.10	24.40	2.00	0.429	0.544x0.625	1.123	0.495	0.628	0.952	0.078
H2143	X	X	8	1.25	11.90	22.30	20.30	9.20	11.10	X	X	0.464	0.870	0.792	0.359	0.433	X	X

# METAL SCREW & BOLT

**Product No.:** H2092

**Head style:** Six-lobe and slot truss

**Position:** Light, fan, heat shield

**Metric:** M5



Product Details

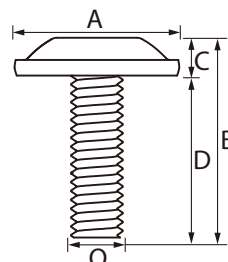

Part No.	Metric	Washer	Threads	Pitch	mm							inch						
										Washer							Washer	
					O	A	B	C	D	E	F	O	A	B	C	D	E	F
H2078	X	X	10	1.80	6.30	14.10	22.60	3.30	19.30	X	X	0.246	0.550	0.881	0.129	0.753	X	X
H2092	M5	X	18	0.80	4.90	15.60	18.00	3.40	14.60	X	X	0.191	0.608	0.702	0.133	0.569	X	X
H2233	M6	X	15	1.00	5.90	11.70	19.30	3.50	15.80	X	X	0.230	0.456	0.753	0.137	0.616	X	X
H2251	M8	X	10	1.25	8.00	13.90	26.00	5.80	20.20	X	X	0.312	0.542	1.014	0.226	0.788	X	X
H2260	X	X	6	2.20	5.20	11.90	19.30	3.00	16.30	X	X	0.203	0.464	0.753	0.117	0.636	X	X
H2275	X	X	6	2.31	5.10	14.40	19.30	3.80	16.00	X	X	0.199	0.562	0.753	0.148	0.624	X	X



H2070

**Head style:** Trox truss washer  
**Position:** Front and rear bumper, grille, fender flare, speaker



H2094

**Head style:** Trox truss  
**Position:** Light, front bumper  
**Metric:** X



H2095

**Head style:** Trox round washer  
**Position:** Genuine screw  
**Metric:** X



H2096

**Head style:** Trox truss  
**Position:** Camera  
**Metric:** X

## METAL SCREW & BOLT



H2117

**Head style:** Trox pan washer  
**Position:** Genuine screw  
**Metric:** M6



H2126

**Head style:** Trox truss  
**Position:** Heat shield, bumper, wheelarch, fender



H2182

**Head style:** Trox truss  
**Position:** Front bumper, hood, seat  
**Metric:** X



H2189

**Head style:** Trox pan washer  
**Position:** Tube, wheelarch  
**Metric:** X



H2250

**Head style:** Trox fillister washer-faced  
**Position:** Rear lid, control system  
**Metric:** M5



H2252

**Head style:** Trox truss  
**Position:** Wheelarch, pillar  
**Metric:** X



H2254

**Head style:** Trox truss  
**Position:** Fender, dashboard  
**Metric:** M5



H2256

**Head style:** Trox truss  
**Position:** Hood  
**Metric:** X



H2257

**Head style:** Trox truss  
**Position:** Front bumper, front end  
**Metric:** X



H2259

**Head style:** Trox truss washer  
**Position:** Genuine screw  
**Metric:** M6



H2262

**Head style:** Trox truss  
**Position:** Front bumper, rear tray  
**Metric:** M6



H2263

**Head style:** Trox truss  
**Position:** Front bumper, engine control  
**Metric:** X



H2264

**Head style:** Trox truss  
**Position:** Door panel, roof, seat, carpet



H2265

**Head style:** Trox truss  
**Position:** Hood, pillar, air tube  
**Metric:** X



H2266

**Head style:** Trox truss  
**Position:** Front bumper, licence plate  
**Metric:** X



H2267

**Head style:** Trox fillister  
**Position:** Headlight, fuel gas tank, armrest



H2268

**Head style:** Trox truss  
**Position:** Dashboard, console, carpet, door panel



H2269

**Head style:** Trox truss  
**Position:** Brake, coolant system  
**Metric:** M6



H2270

**Head style:** Trox truss  
**Position:** Roof, coolant system  
**Metric:** M6



H2271

**Head style:** Trox truss  
**Position:** Sliding roof, rear bumper  
**Metric:** M6



# METAL SCREW & BOLT



H2272

**Head style:** Trox truss  
**Position:** Side moulding, door panel, console



H2273

**Head style:** Trox truss  
**Position:** Radiator, carpet, pillar, intake, vacuum



H2274

**Head style:** Trox truss  
**Position:** Door panel  
**Metric:** X



H2276

**Head style:** Trox truss  
**Position:** Fender  
**Metric:** M6



H2287

**Head style:** Trox truss  
**Position:** Rocker panel, side moulding  
**Metric:** X



H2288

**Head style:** Trox pan washer  
**Position:** Rocker panel, side moulding, pillar



H2289

**Head style:** Trox pan washer  
**Position:** Front bumper, radiator, headlight  
**Metric:** M6



H2290

**Head style:** Trox pan washer  
**Position:** Headlight  
**Metric:** M6

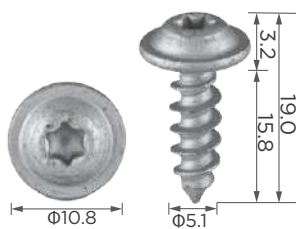

H2311

**Head style:** Trox truss  
**Position:** Front bumper, air duct, engine electrical



H2313

**Head style:** Trox truss  
**Position:** Door panel  
**Metric:** X



H2321

**Head style:** Trox truss  
**Position:** Headlight, door panel, engine  
**Metric:** X



H2325

**Head style:** Trox truss washer  
**Position:** Rocker panel, side moulding  
**Metric:** X



H2326

**Head style:** Trox truss  
**Position:** Inner handle, electronic power supply, lightgate, lock system, radiator  
**Metric:** M6



H2328

**Head style:** Trox round washer  
**Position:** Door panel  
**Metric:** X



H2330

**Head style:** Trox truss  
**Position:** Genuine screw  
**Metric:** X



H2334

**Head style:** Trox pan  
**Position:** Genuine screw  
**Metric:** M6



H2335

**Head style:** Trox truss  
**Position:** Genuine screw  
**Metric:** M6

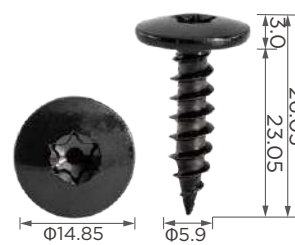

H2348

**Head style:** Trox truss  
**Position:** Genuine screw  
**Metric:** X



H2349

**Head style:** Trox truss  
**Position:** Genuine screw  
**Metric:** X

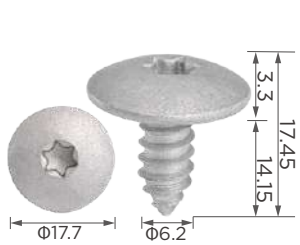

H2363

**Head style:** Trox truss  
**Position:** Fender liner, front bumper, fender  
**Metric:** X

## METAL SCREW & BOLT



H2372

**Head style:** Trox truss  
**Position:** Genuine screw  
**Metric:** X



H2399

**Head style:** Trox truss  
**Position:** Air conditioning condenser, window



H2381

**Head style:** Trox truss  
**Position:** Emblem, front bumper  
**Metric:** X



H2397

**Head style:** Trox truss  
**Position:** Fender liner  
**Metric:** X



H2398

**Head style:** Trox truss  
**Position:** Tailgate interior panel, door panel, mirror, dashboard



H2373

**Head style:** Trox truss  
**Position:** Door panel  
**Metric:** X



H2007

**Head style:** Phillips hexagon washer  
**Position:** Front bumper, splash guard  
**Metric:** X



H2008

**Head style:** Phillips hexagon washer  
**Position:** Front bumper, splash guard  
**Metric:** Mx



H2009

**Head style:** Phillips hexagon washer  
**Position:** Splash guard  
**Metric:** X



H2014

**Head style:** Phillips pan  
**Position:** Genuine screw  
**Metric:** X



H2019

**Head style:** Phillips hexagon washer  
**Position:** Genuine screw  
**Metric:** X



H2020

**Head style:** Phillips binding  
**Position:** Genuine screw  
**Metric:** X



H2021

**Head style:** Phillips hexagon washer  
**Position:** Genuine screw  
**Metric:** X



H2031

**Head style:** Phillips hexagon washer  
**Position:** Genuine screw  
**Metric:** X



# METAL SCREW & BOLT



H2033

**Head style:** Phillips round washer  
**Position:** Genuine screw  
**Metric:** X



H2039

**Head style:** Phillips round washer  
**Position:** Genuine screw  
**Metric:** X



H2041

**Head style:** Phillips truss  
**Position:** Genuine screw  
**Metric:** X



H2053

**Head style:** Phillips truss  
**Position:** Genuine screw  
**Metric:** X



H2054

**Head style:** Phillips pan  
**Position:** Genuine screw  
**Metric:** X



H2055

**Head style:** Phillips pan  
**Position:** Genuine screw  
**Metric:** X



H2056

**Head style:** Phillips pan  
**Position:** Genuine screw  
**Metric:** X



H2057

**Head style:** Phillips hexagon with nut  
**Position:** Genuine screw  
**Metric:** M4



H2058

**Head style:** Phillips hexagon washer with nut  
**Position:** Genuine screw  
**Metric:** M5

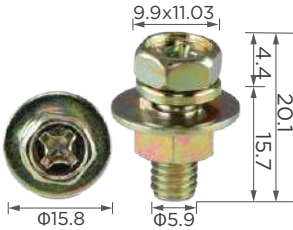

H2062

**Head style:** Phillips hexagon washer with nut  
**Position:** Genuine screw  
**Metric:** M6



H2064

**Head style:** Phillips truss  
**Position:** Genuine screw  
**Metric:** X



H2065

**Head style:** Phillips truss  
**Position:** Console, door panel, head light, rear tray, hood

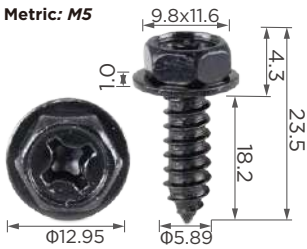

H2066

**Head style:** Phillips hexagon washer  
**Position:** Front and rear bumper, splash guard



H2067

**Head style:** Phillips hexagon washer  
**Position:** Genuine screw  
**Metric:** X



H2069

**Head style:** Phillips truss  
**Position:** Splash guard, fender, rocker panel



H2077

**Head style:** Phillips truss  
**Position:** Rocker panel, splash guard  
**Metric:** X



H2081

**Head style:** Phillips truss  
**Position:** Front bumper, side moulding  
**Metric:** X



H2093

**Head style:** Phillips truss  
**Position:** Air filter, engine  
**Metric:** X



H2109

**Head style:** Phillips hexagon washer  
**Position:** Genuine screw  
**Metric:** M6



H2110

**Head style:** Phillips hexagon washer  
**Position:** Genuine screw  
**Metric:** M6

## METAL SCREW & BOLT



H2130

**Head style:** Phillips hexagon washer  
**Position:** Radiator support  
**Metric:** X



H2131

**Head style:** Phillips hexagon washer  
**Position:** Wheelarch, fender  
**Metric:** X



H2133

**Head style:** Phillips hexagon washer  
**Position:** Genuine screw  
**Metric:** X



H2135

**Head style:** Phillips hexagon washer-faced  
**Position:** Front bumper  
**Metric:** x



H2136

**Head style:** Phillips hexagon washer  
**Position:** Front and rear bumper  
**Metric:** X



H2152

**Head style:** Phillips hexagon washer  
**Position:** Console, door panel  
**Metric:** X



H2167

**Head style:** Phillips hexagon washer-faced  
**Position:** Genuine screw



H2168

**Head style:** Phillips truss  
**Position:** Rocker panel, wheelarch, console, spoiler



H2175

**Head style:** Phillips hexagon washer  
**Position:** Genuine screw  
**Metric:** X



H2177

**Head style:** Phillips hexagon washer  
**Position:** Cowl  
**Metric:** X



H2178

**Head style:** Phillips hexagon washer  
**Position:** Dashboard, console, armrest box  
**Metric:** M6



H2180

**Head style:** Phillips truss  
**Position:** Wheelarch, rear bumper  
**Metric:** X



H2181

**Head style:** Phillips truss  
**Position:** Wheelarch, underbody, frond end



H2190

**Head style:** Phillips hexagon washer  
**Position:** Genuine screw  
**Metric:** M



H2192

**Head style:** Phillips hexagon washer  
**Position:** Front bumper, wheelarch, splash guard



H2193

**Head style:** Phillips truss  
**Position:** Door panel, rear tray, pillar  
**Metric:** X



H2195

**Head style:** Phillips truss  
**Position:** Front and rear bumper  
**Metric:** X



H2226

**Head style:** Phillips truss  
**Position:** Genuine screw  
**Metric:** X



H2227

**Head style:** Phillips truss  
**Position:** Genuine screw  
**Metric:** X



H2228

**Head style:** Phillips truss  
**Position:** Door panel, seat, front end  
**Metric:** X

# METAL SCREW & BOLT



**H2229**  
**Head style:** Phillips truss  
**Position:** Genuine screw  
**Metric:** M8



**H2231**  
**Head style:** Phillips truss  
**Position:** Genuine screw  
**Metric:** X



**H2232**  
**Head style:** Phillips truss  
**Position:** Genuine screw  
**Metric:** X



**H2236**  
**Head style:** Phillips truss washer  
**Position:** Genuine screw  
**Metric:** X

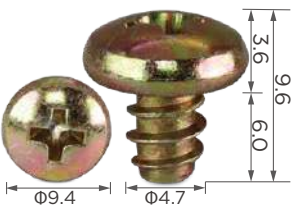

**H2258**  
**Head style:** Phillips truss  
**Position:** Rear lid, seat  
**Metric:** X



**H2261**  
**Head style:** Phillips fillister  
**Position:** Front bumper  
**Metric:** X



**H2310**  
**Head style:** Phillips truss  
**Position:** Door panel  
**Metric:** X



**H2316**  
**Head style:** Phillips fillister  
**Position:** Rear lid, rear tray  
**Metric:** X



**H2318**  
**Head style:** Phillips fillister  
**Position:** Front bumper, liftgate  
**Metric:** X



**H2327**  
**Head style:** Phillips truss washer  
**Position:** Genuine screw  
**Metric:** X



**H2336**  
**Head style:** Phillips truss  
**Position:** Genuine screw  
**Metric:** X



**H2338**  
**Head style:** Phillips hexagon washer  
**Position:** Front and rear bumper, splash guard



**H2339**  
**Head style:** Phillips pan  
**Position:** Genuine screw  
**Metric:** X



**H2340**  
**Head style:** Phillips hexagon washer  
**Position:** Genuine screw  
**Metric:** X



**H2345**  
**Head style:** Phillips truss  
**Position:** Genuine screw  
**Metric:** X



**H2346**  
**Head style:** Phillips truss  
**Position:** Genuine screw  
**Metric:** X



**H2347**  
**Head style:** Phillips truss  
**Position:** Genuine screw  
**Metric:** X



**H2352**  
**Head style:** Phillips hexagon washer  
**Position:** Genuine screw  
**Metric:** X



**H2355**  
**Head style:** Phillips truss  
**Position:** Wheelarch, fender liner  
**Metric:** X



**H2368**  
**Head style:** Phillips pan  
**Position:** Genuine screw  
**Metric:** X



# METAL SCREW & BOLT



H2369

**Head style:** Phillips truss  
**Position:** Fog light, front bumper  
**Metric:** X



H2370

**Head style:** Phillips truss  
**Position:** Fender flare, side moulding  
**Metric:** X



H2371

**Head style:** Phillips hexagon washer  
**Position:** Phillips hexagon washer  
**Metric:** X



H2383

**Head style:** Phillips truss  
**Position:** Front and rear bumper, grille  
**Metric:** X



H2005

**Head style:** Full-bearing hexagon washer  
**Position:** Fender, front bumper  
**Metric:** X



H2034

**Head style:** Full-bearing hexagon washer  
**Position:** Fender  
**Metric:** M6



H2037

**Head style:** Full-bearing hexagon washer  
**Position:** Engine compartment  
**Metric:** X



H2038

**Head style:** Full-bearing hexagon washer  
**Position:** Wheelarch, rear bumper  
**Metric:** X



H2040

**Head style:** Full-bearing hexagon washer  
**Position:** Genuine screw  
**Metric:** X



H2059

**Head style:** Full-bearing hexagon washer-faced with nut  
**Position:** Genuine screw  
**Metric:** M6



H2060

**Head style:** Full-bearing hexagon washer-faced with nut  
**Position:** Genuine screw

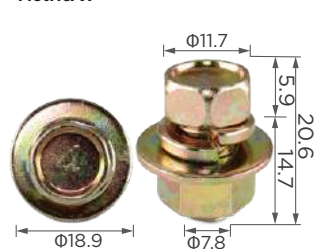

H2061

**Head style:** Full-bearing hexagon with nut  
**Position:** Genuine screw  
**Metric:** M8



H2063

**Head style:** Full-bearing hexagon with nut  
**Position:** Genuine screw  
**Metric:** M6



H2071

**Head style:** Full-bearing hexagon washer  
**Position:** Front bumper  
**Metric:** M8



H2072

**Head style:** Full-bearing hexagon washer-faced  
**Position:** Genuine screw  
**Metric:** M8



H2073

**Head style:** Full-bearing hexagon washer  
**Position:** Back window shelf, grille, rear folding  
**Metric:** M6

# METAL SCREW & BOLT



H2074

**Head style:** Full-bearing hexagon washer  
**Position:** Genuine screw  
**Metric:** M6



H2075

**Head style:** Full-bearing hexagon washer  
**Position:** Wiring harness  
**Metric:** M6



H2076

**Head style:** Full-bearing hexagon washer  
**Position:** Genuine screw  
**Metric:** X



H2082

**Head style:** Full-bearing hexagon washer  
**Position:** Rear moulding, engine fuel  
**Metric:** M5



H2083

**Head style:** Full-bearing hexagon washer  
**Position:** Hood  
**Metric:** M8



H2084

**Head style:** Full-bearing hexagon washer  
**Position:** Genuine screw  
**Metric:** M6



H2085

**Head style:** Full-bearing hexagon washer  
**Position:** Tube  
**Metric:** M5



H2086

**Head style:** Full-bearing hexagon washer  
**Position:** Front bumper  
**Metric:** M6



H2087

**Head style:** Trox fillister  
**Position:** Exhaust gas turbo charger  
**Metric:** M8



H2103

**Head style:** Full-bearing hexagon washer  
**Position:** Seat belt, dashboard, front bumper, roof, heat insulation  
**Metric:** M6



H2104

**Head style:** Full-bearing hexagon washer  
**Position:** Genuine screw  
**Metric:** M6



H2105

**Head style:** Full-bearing hexagon washer  
**Position:** Genuine screw  
**Metric:** M5



H2106

**Head style:** Full-bearing hexagon washer  
**Position:** Genuine screw  
**Metric:** M8



H2107

**Head style:** Full-bearing hexagon washer  
**Position:** Genuine screw  
**Metric:** M6



H2108

**Head style:** Full-bearing hexagon washer  
**Position:** Genuine screw  
**Metric:** X

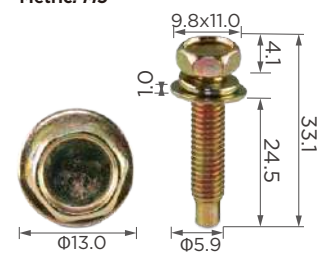

H2111

**Head style:** Full-bearing hexagon washer  
**Position:** Genuine screw  
**Metric:** M6



H2112

**Head style:** Full-bearing hexagon washer  
**Position:** Genuine screw  
**Metric:** M5

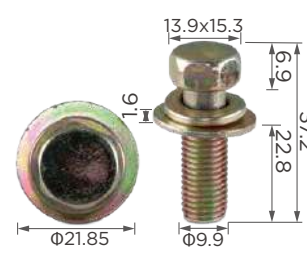

H2113

**Head style:** Full-bearing hexagon washer  
**Position:** Genuine screw,  
**Metric:** X



H2116

**Head style:** Full-bearing hexagon washer  
**Position:** Genuine screw  
**Metric:** X



H2123

**Head style:** Full-bearing hexagon washer  
**Position:** Genuine screw  
**Metric:** X

# METAL SCREW & BOLT



H2124

**Head style:** Full-bearing hexagon washer  
**Position:** Genuine screw  
**Metric:** X



H2132

**Head style:** Full-bearing hexagon washer  
**Position:** Seat belt  
**Metric:** X



H2134

**Head style:** Full-bearing hexagon washer-faced  
**Position:** Radiator support  
**Metric:** M6



H2141

**Head style:** Full-bearing hexagon washer-faced  
**Position:** Plug sub, drain  
**Metric:** M10



H2142

**Head style:** Hexagon drive cheese head  
**Position:** Transmission case, oil pan  
**Metric:** M10



H2143

**Head style:** Full-bearing hexagon washer-faced  
**Position:** Oil pan  
**Metric:** X



H2173

**Head style:** Full-bearing hexagon washer  
**Position:** Genuine screw  
**Metric:** X



H2174

**Head style:** Trox pan washer  
**Position:** Genuine screw  
**Metric:** M6



H2187

**Head style:** Full-bearing hexagon washer  
**Position:** Front bumper, wheelarch, fender



H2205

**Head style:** Full-bearing hexagon washer  
**Position:** Steering system  
**Metric:** X



H2206

**Head style:** Full-bearing hexagon washer  
**Position:** Genuine screw  
**Metric:** X



H2207

**Head style:** Full-bearing hexagon washer  
**Position:** Genuine screw  
**Metric:** X



H2208

**Head style:** Full-bearing hexagon washer-faced  
**Position:** Genuine screw



H2209

**Head style:** Full-bearing hexagon washer  
**Position:** Genuine screw  
**Metric:** X



H2210

**Head style:** Full-bearing hexagon washer  
**Position:** Genuine screw  
**Metric:** X

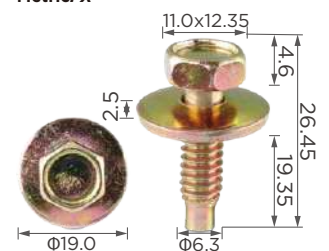

H2211

**Head style:** Full-bearing hexagon washer  
**Position:** Genuine screw  
**Metric:** X



H2212

**Head style:** Full-bearing hexagon washer  
**Position:** Genuine screw  
**Metric:** X



H2213

**Head style:** Full-bearing hexagon washer-faced  
**Position:** Genuine screw



H2214

**Head style:** Full-bearing hexagon washer  
**Position:** Control system  
**Metric:** M8



H2215

**Head style:** Full-bearing hexagon washer-faced  
**Position:** Control system  
**Metric:** M8





## METAL SCREW & BOLT



H2366

**Head style:** Full-bearing hexagon washer  
**Position:** Rocker panel, wheelarch  
**Metric:** X



H2394

**Head style:** Full-bearing hexagon washer  
**Position:** Genuine screw  
**Metric:** X



H2078

**Head style:** Slotted truss  
**Position:** Genuine screw  
**Metric:** X



H2092

**Head style:** Six-lobe and slot truss  
**Position:** Light, fan, heat shield  
**Metric:** M5



H2233

**Head style:** Slotted pan  
**Position:** Genuine screw  
**Metric:** M6



H2251

**Head style:** 12 point socket inner cheese  
**Position:** Rear lid, door panel  
**Metric:** M8



H2260

**Head style:** Six-lobe and slot truss  
**Position:** Front bumper, intake, headlight  
**Metric:** X



H2275

**Head style:** Six-lobe and slot truss  
**Position:** Rear bumper, grille, hood  
**Metric:** X

# METAL BLIND RIVET

**Product No.:** H2030

**Material:** Metal  
**Color:** Silvery Dacromet  
**Position:** Wheelarch



Product Details

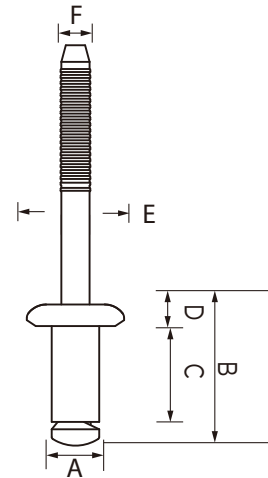

Part No.	Color	mm						in					
		A	B	C	D	E	F	A	B	C	D	E	F
H2291	Silvery dacromet	3.05	11.15	8.85	1.00	6.00	1.80	0.12	0.43	0.35	0.04	0.23	0.07
H2032	Silvery dacromet	3.10	11.30	8.00	1.50	9.10	1.90	0.12	0.44	0.31	0.06	0.35	0.07
H2292	Silvery dacromet	3.10	8.95	6.25	0.95	6.30	2.00	0.12	0.35	0.24	0.04	0.25	0.08
H2016	Black dacromet	3.80	11.20	8.30	1.30	7.80	1.70	0.15	0.44	0.32	0.05	0.30	0.07
H2012	Black dacromet	3.90	16.20	12.20	1.60	12.00	2.20	0.15	0.63	0.48	0.06	0.47	0.09
H2013	Silvery dacromet	3.90	10.90	6.00	0.90	6.30	1.70	0.15	0.43	0.23	0.04	0.25	0.07
H2283	Silvery dacromet	3.90	23.30	16.30	1.40	8.00	2.30	0.15	0.91	0.64	0.05	0.31	0.09
H2018	Black dacromet	3.95	18.75	15.40	1.70	11.70	2.10	0.15	0.73	0.60	0.07	0.46	0.08
H2029	Silvery dacromet	3.95	13.50	10.10	1.40	11.60	2.00	0.15	0.53	0.39	0.05	0.45	0.08
H2278	Silvery dacromet	3.95	10.00	6.20	1.25	7.75	2.20	0.15	0.39	0.24	0.05	0.30	0.09
H2119	Silvery dacromet / black dacromet	4.00	22.00	18.20	1.60	7.90	2.30	0.16	0.86	0.71	0.06	0.31	0.09
H2150	Black dacromet	4.00	15.70	10.20	1.00	5.90	1.90	0.16	0.61	0.40	0.04	0.23	0.07
H2015	Silvery dacromet	4.10	13.20	10.30	1.50	6.00	2.70	0.16	0.51	0.40	0.06	0.23	0.11
H2324	Silvery dacromet	4.65	24.80	20.35	1.80	11.60	2.85	0.18	0.97	0.79	0.07	0.45	0.11
H2017	Silvery dacromet	4.70	19.60	15.60	1.80	11.70	2.20	0.18	0.76	0.61	0.07	0.46	0.09
H2120	Silvery dacromet	4.70	24.00	20.70	2.00	9.80	2.85	0.18	0.94	0.81	0.08	0.38	0.11
H2243	Silvery dacromet	4.75	16.20	11.10	2.00	12.70	2.70	0.19	0.63	0.43	0.08	0.50	0.11
H2022	Silvery dacromet	4.80	15.10	11.60	1.85	13.10	2.90	0.19	0.59	0.45	0.07	0.51	0.11
H2118	Silvery dacromet	4.80	24.55	21.00	2.00	15.60	2.80	0.19	0.96	0.82	0.08	0.61	0.11
H2010	Silvery dacromet	5.50	16.60	11.50	1.90	12.70	2.65	0.21	0.65	0.45	0.07	0.50	0.10
H2284	Silvery dacromet	6.00	22.70	18.55	3.30	15.80	2.70	0.23	0.89	0.72	0.13	0.62	0.11
H2294	Silvery dacromet	6.00	16.90	16.80	2.30	18.50	3.70	0.23	0.66	0.66	0.09	0.72	0.14
H2337	Silvery dacromet	6.00	24.90	19.40	2.55	15.70	2.70	0.23	0.97	0.76	0.10	0.61	0.11
H2011	Black dacromet	6.30	18.30	13.20	2.00	12.70	3.90	0.25	0.71	0.51	0.08	0.50	0.15
H2183	Silvery dacromet	6.30	15.25	10.32	1.93	10.60	3.70	0.25	0.59	0.40	0.08	0.41	0.14
H2343	Silvery dacromet	6.30	19.00	12.90	3.10	13.10	3.85	0.25	0.74	0.50	0.12	0.51	0.15
H2350	Silvery dacromet	6.35	18.40	13.00	2.10	12.90	3.95	0.25	0.72	0.51	0.08	0.50	0.15
H2030	Silvery dacromet	6.40	19.30	12.90	2.90	13.10	3.80	0.25	0.75	0.50	0.11	0.51	0.15
H2277	Silvery dacromet	6.40	19.40	12.50	2.90	13.00	4.10	0.25	0.76	0.49	0.11	0.51	0.16

# METAL BLIND RIVET

Part No.	Color	mm						in					
		A	B	C	D	E	F	A	B	C	D	E	F
H2279	Silvery dacromet	6.40	21.70	14.70	3.15	13.00	4.15	0.25	0.85	0.57	0.12	0.51	0.16
H2280	Silvery dacromet	6.40	21.80	15.40	3.15	13.00	4.10	0.25	0.85	0.60	0.12	0.51	0.16
H2281	Silvery dacromet	6.45	22.30	18.55	3.15	13.00	4.10	0.25	0.87	0.72	0.12	0.51	0.16
H2282	Silvery dacromet	6.45	20.40	16.50	2.90	12.90	4.10	0.25	0.80	0.64	0.11	0.50	0.16



H2010

**Material:** Metal  
**Color:** Silvery Dacromet  
*Gas filler door*



H2011

**Material:** Metal  
**Color:** Black Dacromet  
*Fuel tank and tube, quarter panel, fuel door*



H2012

**Material:** Metal  
**Color:** Black Dacromet  
*Aluminum rivet*

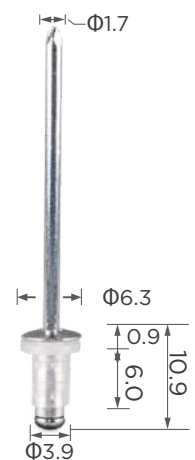

H2013

**Material:** Metal  
**Color:** Silvery Dacromet  
*Rocker panel*

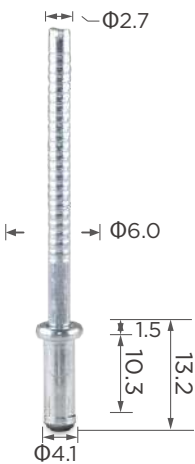

H2015

**Material:** Metal  
**Color:** Silvery Dacromet  
*Steel rivet & mandrel*



H2016

**Material:** Metal  
**Color:** Black Dacromet  
*Fender, rocker panel*



H2017

**Material:** Metal  
**Color:** Silvery Dacromet  
*Speaker, door panel*



H2018

**Material:** Metal  
**Color:** Black Dacromet  
*Fender, rocker panel*

# METAL BLIND RIVET

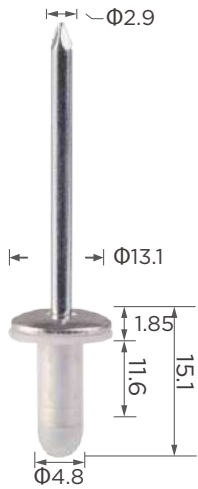

H2022

**Material:** Metal  
**Color:** Silvery Dacromet  
**Rear bumper**



H2029

**Material:** Metal  
**Color:** Silvery Dacromet  
**Aluminum rivet**



H2030

**Material:** Metal  
**Color:** Silvery Dacromet  
**Door panel, pillar**

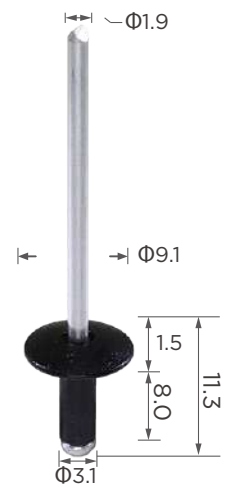

H2032

**Material:** Metal  
**Color:** Silvery Dacromet  
**Fender flare**

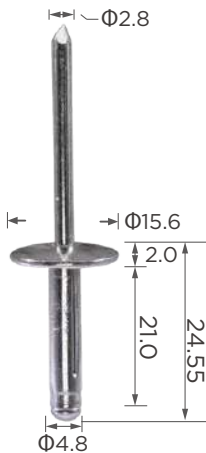

H2118

**Material:** Metal  
**Color:** Silvery Dacromet  
**Aluminum rivet**

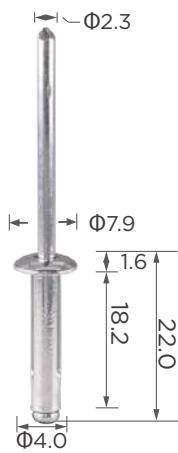

H2119

**Material:** Metal  
**Color:** Silvery/ black Dacromet  
**Front bumper, wheelarch, electrical system**

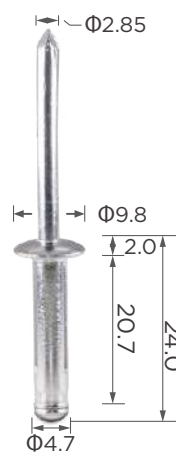

H2120

**Material:** Metal  
**Color:** Silvery Dacromet  
**Aluminum rivet**

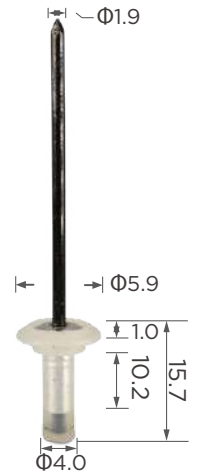

H2150

**Material:** Metal  
**Color:** Black Dacromet  
**Windshield, moulding**

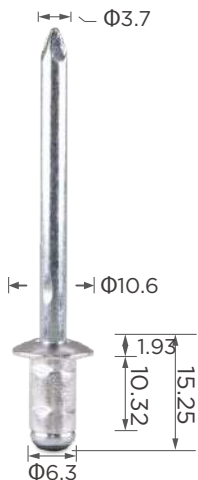

H2183

**Material:** Metal  
**Color:** Silvery Dacromet  
**Aluminum rivet**

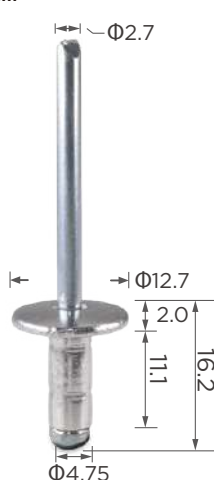

H2243

**Material:** Metal  
**Color:** Silvery Dacromet  
**Aluminum rivet**

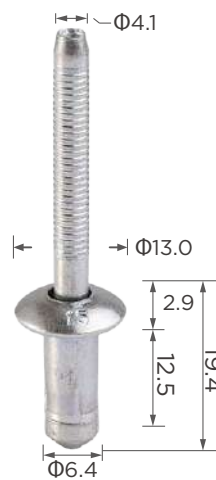

H2277

**Material:** Metal  
**Color:** Silvery  
**Steel rivet & mandrel**

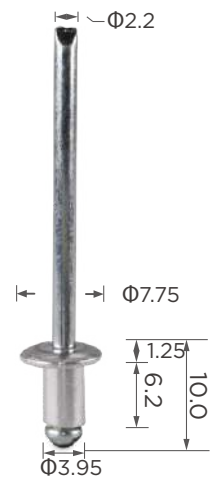

H2278

**Material:** Metal  
**Color:** Silvery Dacromet  
**Steel rivet & mandrel**

# METAL BLIND RIVET

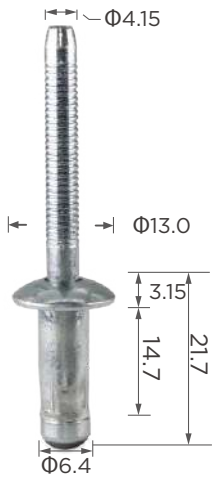

H2279

**Material:** Metal  
**Color:** Silvery Dacromet  
**Steel rivet & mandrel**

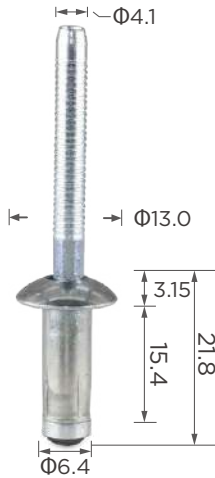

H2280

**Material:** Metal  
**Color:** Silvery Dacromet  
**Steel rivet & mandrel**

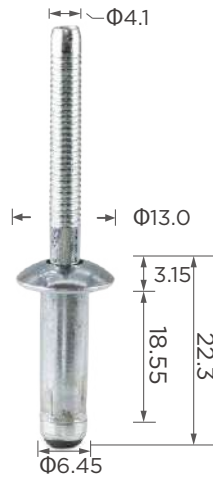

H2281

**Material:** Metal  
**Color:** Silvery Dacromet  
**Steel rivet & mandrel**

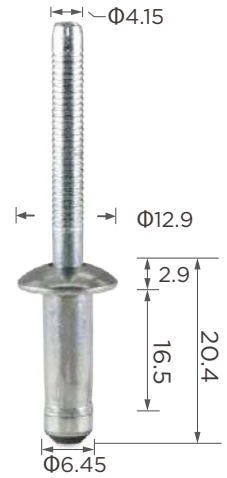

H2282

**Material:** Metal  
**Color:** Silvery Dacromet  
**Steel rivet & mandrel**

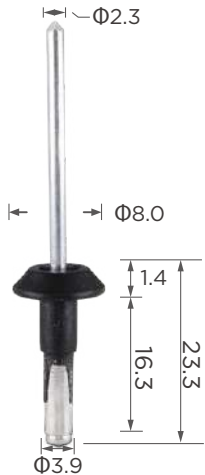

H2283

**Material:** Metal  
**Color:** Silvery Dacromet  
**Bumper, wheelarch**



H2284

**Material:** Metal  
**Color:** Silvery Dacromet  
**Aluminum rivet**



H2291

**Material:** Metal  
**Color:** Silvery Dacromet  
**Grille, pillar, moulding**

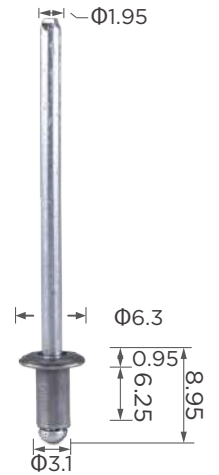

H2292

**Material:** Metal  
**Color:** Silvery Dacromet  
**Front fender**



H2294

**Material:** Metal  
**Color:** Silvery Dacromet  
**Window**

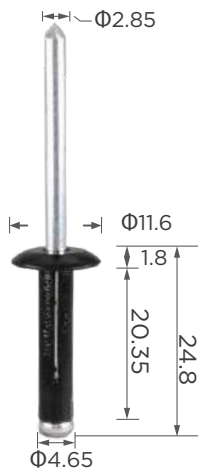

H2324

**Material:** Metal  
**Color:** Silvery Dacromet  
**Aluminum rivet**



H2337

**Material:** Metal  
**Color:** Silvery Dacromet  
**Aluminum rivet**



H2343

**Material:** Metal  
**Color:** Silvery Dacromet  
**Aluminum rivet**



# METAL BLIND RIVET



H2350

**Material:** Metal  
**Color:** Silvery Dacromet  
**Aluminum rivet**

## METAL GASKET & WASHER

**Product No.:** H2088

**Material:** Metal  
**Color:** Bronze  
**Position:** Oil drain plug

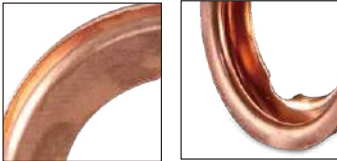

Product Details

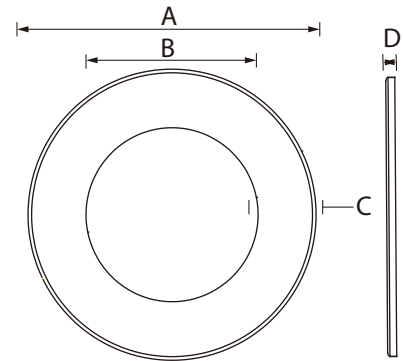

Part No.	Material	Color	mm				in			
			A	B	C	D	A	B	C	D
H1116	Metal	Silvery coa ng	30.10	19.90	4.80	3.10	1.174	0.776	0.187	0.121
H1117	Metal	Silvery coa ng	30.13	12.10	8.90	4.58	1.175	0.472	0.347	0.179
H2080	Metal	Black coa ng	11.90	4.35	3.77	1.00	0.464	0.170	0.147	0.039
H2088	Metal	Bronze coa ng	17.50	11.20	3.30	3.20	0.683	0.437	0.129	0.125
H2125	Metal	Silvery coa ng	22.00	17.00	2.50	2.70	0.858	0.663	0.098	0.105
H2137	Metal	Silvery coa ng	16.31	11.75	2.28	2.20	0.636	0.458	0.089	0.086
H2139	Metal	Silvery coa ng	24.05	17.90	3.07	2.40	0.938	0.698	0.120	0.094
H2163	Metal	Silvery coa ng	21.90	14.20	3.90	2.00	0.854	0.554	0.152	0.078
H2164	Metal	Silvery coa ng	25.50	18.40	3.60	1.95	0.995	0.718	0.140	0.076
H2165	Metal	Silvery coa ng	20.40	14.10	3.20	2.00	0.796	0.550	0.125	0.078
H2170	Metal	Silvery coa ng	24.20	18.20	3.00	2.00	0.944	0.710	0.117	0.078
H2172	Metal	Bronze coa ng	25.70	18.50	3.60	1.55	1.002	0.722	0.140	0.060
H2194	Metal	Silvery coa ng	14.10	5.15	4.97	1.85	0.550	0.201	0.194	0.072
H2197	Metal	Blue coa ng	8.90	4.30	2.30	0.85	0.347	0.168	0.090	0.033
H2293	Metal	Blue coa ng	20.90	12.20	4.20	1.70	0.815	0.476	0.164	0.066
H2299	Metal	Silvery coa ng	12.00	8.95	1.52	1.64	0.468	0.349	0.059	0.064
H2351	Metal	Bronze coa ng	16.25	10.10	3.07	1.50	0.634	0.394	0.120	0.059
H2359	Metal	Silvery	34.20	3.50	15.35	1.10	1.334	0.137	0.599	0.043
H2384	Metal	Silvery	10.00	2.80	7.20	1.20	0.390	0.109	0.281	0.047



**METAL GASKET & WASHER**



**H1116**

**Material:** Metal  
**Color:** Silvery Dacromet  
**Heat shield, underbody, noise insulation, tube locking washer**

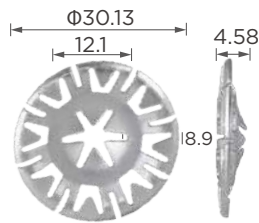

**H1117**

**Material:** Metal  
**Color:** Metal  
**Heat shield, underbody, noise insulation, tube locking washer**



**H2080**

**Material:** Metal  
**Color:** Black Dacromet  
**Heatlight, luggage, oil drain**

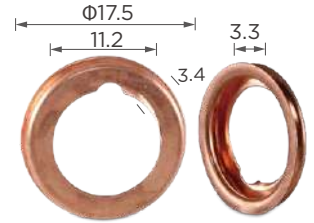

**H2088**

**Material:** Metal  
**Color:** Bronze  
**Gasket**

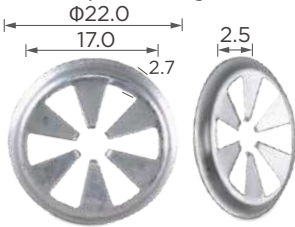

**H2125**

**Material:** Metal  
**Color:** Silvery Dacromet  
**Tube, splash guard, cowl**



**H2137**

**Material:** Metal  
**Color:** Silver Dacromet  
**Oil drain plug gasket**



**H2139**

**Material:** Metal  
**Color:** Silvery Dacromet  
**Oil drain plug gasket**



**H2163**

**Material:** Metal  
**Color:** Silvery Dacromet  
**Oil drain plug gasket**



**H2164**

**Material:** Metal  
**Color:** Silvery Dacromet  
**Oil drain plug gasket**



**H2165**

**Material:** Metal  
**Color:** Silvery Dacromet  
**Oil drain plug gasket**



**H2170**

**Material:** Metal  
**Color:** Silvery Dacromet  
**Oil drain plug gasket**

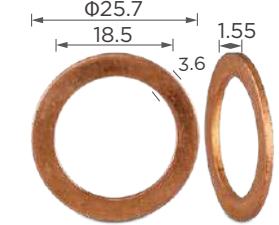

**H2172**

**Material:** Metal  
**Color:** Silvery Dacromet  
**Oil drain plug gasket**

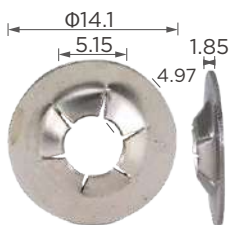

**H2194**

**Material:** Metal  
**Color:** Silvery Dacromet  
**Oil drain plug gasket**



**H2197**

**Material:** Metal  
**Color:** Blue  
**Splash guard, wheelarch**

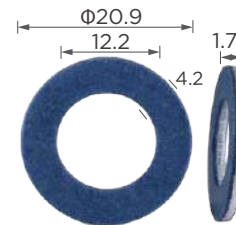

**H2293**

**Material:** Metal  
**Color:** Blue  
**Oil drain plug gasket**

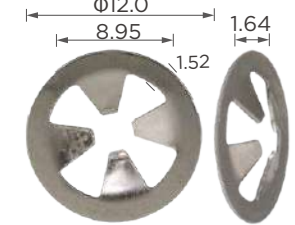

**H2299**

**Material:** Metal  
**Color:** Silvery Dacromet  
**Front and rear bumper**

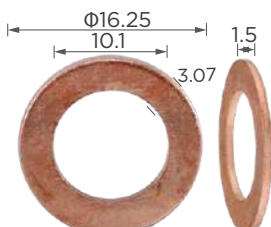

**H2351**

**Material:** Metal  
**Color:** Bronze  
**Front and rear bumper**

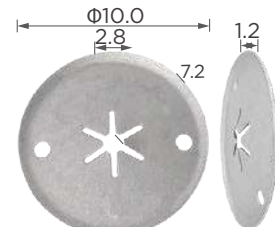

**H2359**

**Material:** Metal  
**Color:** Silvery  
**Undershield, sound ABS**

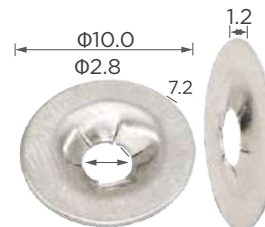

**H2384**

**Material:** Metal  
**Color:** Silvery  
**Front Emblem**

# METAL TRIM PANEL SPRING CLIP

**Product No.:** H2220

**Material:** Metal  
**Color:** Black Dacromet  
**Position:** Carpet, roof, rear tray

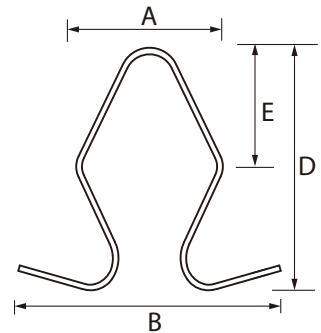
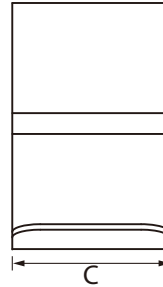

Product Details

Part No.	Color	Position	mm					in				
			A	B	C	D	E	A	B	C	D	E
H2169	Black Dacromet	Rear bumper	3.20	6.15	10.10	9.60	3.70	0.125	0.240	0.394	0.374	0.144
H2223	Black Dacromet	Grille	5.75	10.00	12.00	16.60	9.65	0.224	0.390	0.468	0.647	0.376
H2220	Black Dacromet	Carpet, roof, rear tray	7.80	14.05	8.40	13.00	9.50	0.304	0.548	0.328	0.507	0.371
H2024	Zinc	Pillar, roof, rear tray	8.00	10.53	12.90	14.86	12.84	0.312	0.411	0.503	0.580	0.501
H2202	Silvery Dacromet	Rear tray, pillar, roof	8.60	13.50	8.95	14.30	12.40	0.335	0.527	0.349	0.558	0.484
H2153	Silvery Dacromet	Rear tray, li gate	8.90	14.08	9.10	22.58	16.00	0.347	0.549	0.355	0.881	0.624
H2306	Zinc	Grille	8.90	13.05	12.10	16.16	9.50	0.347	0.509	0.472	0.630	0.371
H2201	Silvery Dacromet	Rear tray, li gate	9.00	16.80	9.00	21.40	19.30	0.351	0.655	0.351	0.835	0.753
H2308	Silvery Dacromet	Door panel, Door sill	9.00	13.40	12.10	16.50	11.00	0.351	0.523	0.472	0.644	0.429
H2296	Black Dacromet	Pillar, roof	9.10	13.80	9.00	16.65	9.90	0.355	0.538	0.351	0.649	0.386
H2186	Silvery Dacromet	Rear tray, li gate	9.35	14.75	9.15	25.00	22.70	0.365	0.575	0.357	0.975	0.885
H1221	Silvery Dacromet	Door panel	9.46	15.64	9.00	15.85	9.57	0.369	0.610	0.351	0.618	0.373
H1222	Silvery/ Black Dacromet	Rear panel, lower	9.83	16.00	9.00	22.19	15.45	0.383	0.624	0.351	0.865	0.603
H2166	Silvery Dacromet	Door panel	10.50	14.20	13.20	14.60	9.10	0.410	0.554	0.515	0.569	0.355
H2028	Silvery Dacromet	Door panel	11.38	7.88	5.30	11.11	4.82	0.444	0.307	0.207	0.433	0.188
H2225	Black Dacromet	Dashboard, console	12.65	18.90	13.50	15.75	8.20	0.493	0.737	0.527	0.614	0.320
H2221	Silvery Dacromet	Pillar, console	12.80	11.38	9.50	16.70	9.85	0.499	0.444	0.371	0.651	0.384
H2356	Zinc	Console, dashboard	13.05	19.70	13.50	16.30	11.60	0.509	0.768	0.527	0.636	0.452



# METAL TRIM PANEL SPRING CLIP

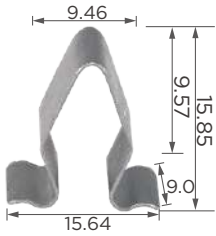

H1221

**Material:** Metal  
**Color:** Silvery Dacromet  
**Door panel**

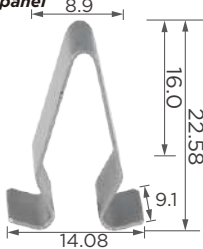

H2153

**Material:** Metal  
**Color:** Silvery Dacromet  
**Rear tray, liftgate**

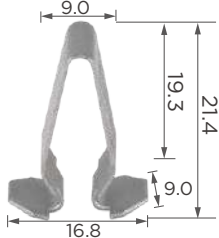

H2201

**Material:** Metal  
**Color:** Silvery Dacromet  
**Rear tray, liftgate**



H2223

**Material:** Metal  
**Color:** Black Dacromet  
**Grille**

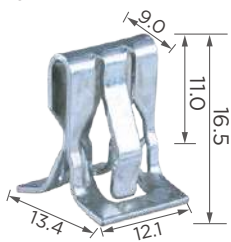

H2308

**Material:** Metal  
**Color:** Silvery Dacromet  
**Door panel, Door sill**



H1222

**Material:** Metal  
**Color:** Silvery/ Black Dacromet  
**Rear panel, lower**

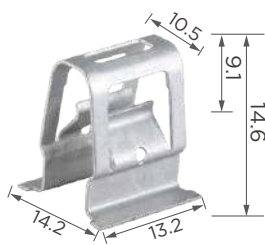

H2166

**Material:** Metal  
**Color:** Silvery Dacromet  
**Door panel**

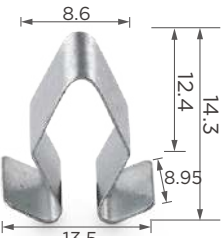

H2202

**Material:** Metal  
**Color:** Black Dacromet  
**Rear tray, pillar, roof**



H2225

**Material:** Metal  
**Color:** Black Dacromet  
**Dashboard, console**

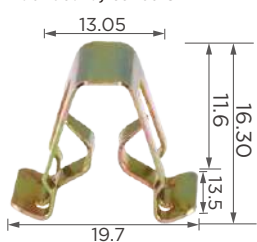

H2356

**Material:** Metal  
**Color:** Zinc  
**Console, dashboard**

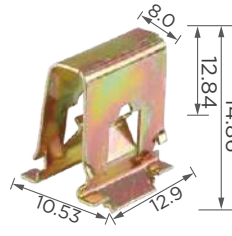

H2024

**Material:** Metal  
**Color:** Zinc  
**Pillar, roof, rear tray**

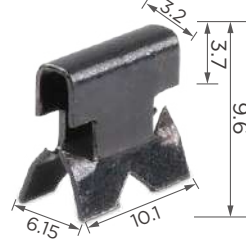

H2169

**Material:** Metal  
**Color:** Black Dacromet  
**Rear bumper**

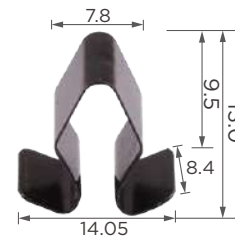

H2220

**Material:** Metal  
**Color:** Black Dacromet  
**Carpet, roof, rear tray**



H2296

**Material:** Metal  
**Color:** Black Dacromet  
**Pillar, roof**

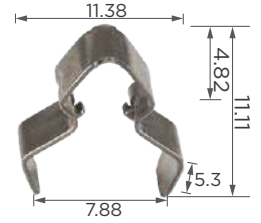

H2028

**Material:** Metal  
**Color:** Silvery Dacromet  
**Door panel**



H2186

**Material:** Metal  
**Color:** Silvery Dacromet  
**Rear tray, liftgate**

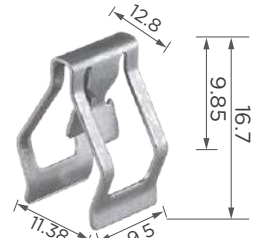

H2221

**Material:** Metal  
**Color:** Black Dacromet  
**Pillar, console**

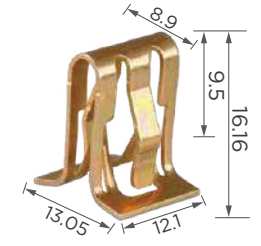

H2306

**Material:** Metal  
**Color:** Zinc  
**Grille**

# METAL U-TYPE NUT

**Product No.:** H2079

**Material:** Nylon  
**Color:** Black  
**Position:** Wheelarch, splash guard, fender



Product Details

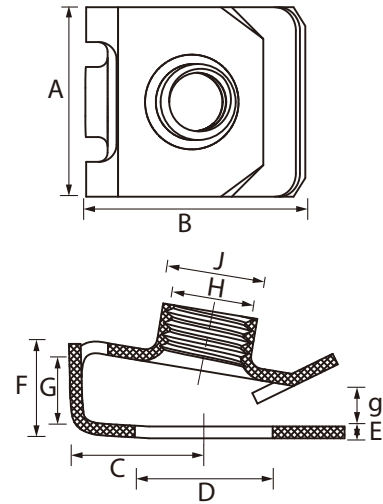

Part No.	Color	mm										inch									
		A	B	C	D	E	F	G(max)	g(min)	H	J	A	B	C	D	E	F	G(max)	g(min)	H	J
H1146	Silvery	16.20	18.73	8.28	9.40	0.80	6.60	4.75	1.56	5.02	6.50	0.632	0.730	0.323	0.367	0.031	0.257	0.185	0.061	0.196	0.254
H2000	Black	16.10	20.62	11.40	6.10	0.60	4.75	3.50	/	3.80	/	0.628	0.804	0.445	0.238	0.023	0.185	0.137	/	0.148	/
H2004	Blue zinc	14.00	20.35	8.66	5.60	0.60	5.60	4.30	0.95	3.10	/	0.546	0.794	0.338	0.218	0.023	0.218	0.168	0.037	0.121	/
H2006	Black	13.40	20.52	10.28	8.00	0.75	3.81	2.35	/	1.91	/	0.523	0.800	0.401	0.312	0.029	0.149	0.092	/	0.074	/
H2023	Silvery	16.30	19.61	9.33	7.54	0.90	6.10	4.26	/	5.12	/	0.636	0.765	0.364	0.294	0.035	0.238	0.166	/	0.200	/
H2025	Black	16.20	20.36	8.43	3.65	0.50	5.00	3.95	/	9.60	/	0.632	0.794	0.329	0.142	0.020	0.195	0.154	/	0.374	/
H2042	Silvery	15.10	20.80	11.48	7.00	0.60	7.70	6.37	0.30	4.20	5.80	0.589	0.811	0.448	0.273	0.023	0.300	0.248	0.012	0.164	0.226
H2043	Silvery	11.00	24.03	16.39	6.00	0.60	3.46	2.25	/	3.30	/	0.429	0.937	0.639	0.234	0.023	0.135	0.088	/	0.129	/
H2044	Silvery	12.70	19.97	9.42	5.50	0.70	4.19	2.79	/	3.87	/	0.495	0.779	0.367	0.215	0.027	0.163	0.109	/	0.151	/
H2045	Yellow	11.00	17.30	8.91	4.80	0.50	3.90	2.90	/	3.40	/	0.429	0.675	0.347	0.187	0.020	0.152	0.113	/	0.133	/
H2046	Yellow	14.60	24.80	13.74	7.05	0.70	3.28	1.85	1.02	5.30	/	0.569	0.967	0.536	0.275	0.027	0.128	0.072	0.040	0.207	/
H2047	Yellow	16.00	25.28	11.70	7.00	0.60	4.32	3.09	/	5.20	/	0.624	0.986	0.456	0.273	0.023	0.168	0.121	/	0.203	/
H2048	Yellow	14.50	26.10	13.60	6.00	0.70	4.40	3.00	/	4.30	/	0.566	1.018	0.530	0.234	0.027	0.172	0.117	/	0.168	/
H2049	Yellow	11.00	25.12	16.30	5.70	0.60	3.74	2.54	1.03	3.92	/	0.429	0.980	0.636	0.222	0.023	0.146	0.099	0.040	0.153	/
H2050	Silvery	14.63	25.00	13.40	12.60	0.90	6.25	4.45	1.78	5.41	7.80	0.571	0.975	0.523	0.491	0.035	0.244	0.174	0.069	0.211	0.304
H2051	Black	16.80	25.44	14.37	11.70	1.00	6.63	4.63	1.35	7.67	9.00	0.655	0.992	0.560	0.456	0.039	0.259	0.181	0.053	0.299	0.351
H2079	Black	14.50	24.20	13.59	9.60	0.85	6.41	4.40	2.66	5.25	7.00	0.566	0.944	0.530	0.374	0.033	0.250	0.172	0.104	0.205	0.273
H2097	Silvery	11.00	16.80	8.20	6.30	0.50	4.80	3.80	2.60	3.65	/	0.429	0.655	0.320	0.246	0.020	0.187	0.148	0.101	0.142	/
H2099	Yellow	12.00	17.70	9.80	5.50	0.50	4.10	3.10	/	4.01	/	0.468	0.690	0.382	0.215	0.020	0.160	0.121	/	0.156	/
H2100	Yellow	11.00	16.46	8.00	5.00	0.60	4.02	2.82	0.25	2.76	/	0.429	0.642	0.312	0.195	0.023	0.157	0.110	0.010	0.108	/
H2101	Yellow	11.00	17.27	7.77	4.75	0.60	3.99	2.79	/	3.40	/	0.429	0.674	0.303	0.185	0.023	0.156	0.109	/	0.133	/
H2102	Yellow	11.05	17.80	9.80	5.45	0.50	3.77	2.77	0.35	8.01	/	0.431	0.694	0.382	0.213	0.020	0.147	0.108	0.014	0.312	/
H2121	Black	15.00	30.70	19.49	9.78	1.00	6.53	4.53	2.40	5.36	6.80	0.585	1.197	0.760	0.381	0.039	0.255	0.177	0.094	0.209	0.265
H2122	Black	17.00	33.10	21.28	14.55	1.00	6.95	4.95	3.50	7.60	9.00	0.663	1.291	0.830	0.567	0.039	0.271	0.193	0.137	0.296	0.351
H2127	Silvery	11.00	17.56	8.61	/	0.50	3.67	3.00	2.55	4.00	/	0.429	0.685	0.336	/	0.020	0.143	0.117	0.099	0.156	/
H2128	Black	13.50	26.80	15.80	6.30	0.50	5.11	4.11	0.30	3.30	/	0.527	1.045	0.616	0.246	0.020	0.199	0.160	0.012	0.129	/
H2129	Black	14.10	21.76	10.59	6.30	0.60	4.65	3.45	0.29	3.05	/	0.550	0.849	0.413	0.246	0.023	0.181	0.135	0.011	0.119	/
H2146	Silvery	12.95	25.40	13.37	9.00	0.90	6.00	4.20	2.14	5.20	6.84	0.505	0.991	0.521	0.351	0.035	0.234	0.164	0.083	0.203	0.267
H2147	Black	16.10	21.37	10.00	8.00	0.80	5.11	3.51	/	4.10	/	0.628	0.833	0.390	0.312	0.031	0.199	0.137	/	0.160	/
H2155	Black	12.10	18.20	9.10	7.55	0.95	5.42	3.52	1.87	5.10	/	0.472	0.710	0.355	0.294	0.037	0.211	0.137	0.073	0.199	/



## METAL U-TYPE NUT

Part No.	Color	mm										inch									
		A	B	C	D	E	F	G(max)	g(min)	H	J	A	B	C	D	E	F	G(max)	g(min)	H	J
H2156	Black	17.40	25.85	14.15	11.12	1.00	6.58	4.58	4.50	6.50	8.50	0.679	1.008	0.552	0.434	0.039	0.257	0.179	0.176	0.254	0.332
H2157	Silvery	19.10	23.40	12.21	7.48	0.70	8.20	6.80	/	5.30	/	0.745	0.913	0.476	0.292	0.027	0.320	0.265	/	0.207	/
H2158	Silvery	24.80	24.20	11.70	10.30	0.80	8.80	6.45	/	7.00	/	0.967	0.944	0.456	0.402	0.031	0.343	0.252	/	0.273	/
H2159	Silvery	14.90	24.39	14.18	9.60	0.90	6.60	4.80	2.50	5.20	6.70	0.581	0.951	0.553	0.374	0.035	0.257	0.187	0.098	0.203	0.261
H2160	Black	16.10	22.00	13.07	8.83	0.70	7.00	5.60	/	4.00	7.70	0.628	0.858	0.510	0.344	0.027	0.273	0.218	/	0.156	0.300
H2171	Silvery	14.60	17.96	10.24	5.80	0.60	5.05	3.85	1.83	4.00	/	0.569	0.700	0.399	0.226	0.023	0.197	0.150	0.071	0.156	/
H2184	Silvery	12.60	18.85	10.61	7.40	0.70	3.60	2.20	1.91	3.20	4.90	0.491	0.735	0.414	0.289	0.027	0.140	0.086	0.074	0.125	0.191
H2188	Silvery	12.00	15.15	9.48	5.70	0.60	4.50	3.30	1.56	3.65	/	0.468	0.591	0.370	0.222	0.023	0.176	0.129	0.061	0.142	/
H2196	Black	13.10	19.45	9.28	9.05	0.85	4.35	2.65	/	5.20	7.00	0.511	0.759	0.362	0.353	0.033	0.170	0.103	/	0.203	0.273
H2198	Black	12.10	18.45	8.25	6.00	1.00	5.65	3.65	1.50	5.90	/	0.472	0.720	0.322	0.234	0.039	0.220	0.142	0.059	0.230	/
H2203	Silvery	11.00	17.10	8.33	5.50	0.60	4.65	3.45	0.57	3.10	/	0.429	0.667	0.325	0.215	0.023	0.181	0.135	0.022	0.121	/
H2204	Yellow	16.15	19.15	11.20	7.15	0.60	4.36	3.16	1.79	3.90	/	0.630	0.747	0.437	0.279	0.023	0.170	0.123	0.070	0.152	/
H2241	Black	12.70	19.50	10.43	9.20	0.70	5.85	4.45	/	3.90	/	0.495	0.761	0.407	0.359	0.027	0.228	0.174	/	0.152	/
H2242	Black	10.80	24.00	16.60	6.80	0.50	4.00	3.00	/	3.90	/	0.421	0.936	0.647	0.265	0.020	0.156	0.117	/	0.152	/
H2244	Silvery	12.00	16.20	8.00	6.10	0.50	6.35	3.91	1.60	2.70	/	0.468	0.632	0.312	0.238	0.020	0.248	0.152	0.062	0.105	/
H2245	Black	11.10	16.80	8.00	5.45	0.60	4.60	3.40	/	3.30	/	0.433	0.655	0.312	0.213	0.023	0.179	0.133	/	0.129	/
H2248	Black	13.00	13.25	4.00	/	0.40	4.65	3.85	3.15	3.40	/	0.507	0.517	0.156	/	0.016	0.181	0.150	0.123	0.133	/
H2249	Silvery	15.90	19.00	10.65	7.40	0.70	4.30	2.90	1.85	3.40	/	0.620	0.741	0.415	0.289	0.027	0.168	0.113	0.072	0.133	/
H2255	Silvery	12.60	22.90	15.20	7.40	0.70	5.65	4.25	2.50	3.20	4.90	0.491	0.893	0.593	0.289	0.027	0.220	0.166	0.098	0.125	0.191
H2285	Silvery	16.65	25.00	7.25	9.00	1.00	6.80	4.80	1.17	7.00	9.35	0.649	0.975	0.283	0.351	0.039	0.265	0.187	0.046	0.273	0.365
H2300	Silvery	16.10	23.90	14.35	8.30	1.00	6.90	4.90	2.15	5.25	7.00	0.628	0.932	0.560	0.324	0.039	0.269	0.191	0.084	0.205	0.273
H2305	Silvery	16.70	25.00	14.20	9.00	1.00	6.20	4.20	1.28	5.15	7.15	0.651	0.975	0.554	0.351	0.039	0.242	0.164	0.050	0.201	0.279
H2319	Silvery	15.05	21.95	11.12	6.90	0.60	6.25	5.05	2.00	2.90	/	0.587	0.856	0.434	0.269	0.023	0.244	0.197	0.078	0.113	/
H2320	Silvery	14.80	15.80	8.50	5.25	0.70	3.25	1.85	0.76	4.00	/	0.577	0.616	0.332	0.205	0.027	0.127	0.072	0.030	0.156	/
H2323	Silvery	15.05	17.80	9.27	6.65	0.60	6.50	5.30	1.80	3.75	/	0.587	0.694	0.362	0.259	0.023	0.254	0.207	0.070	0.146	/
H2341	Silvery	8.10	9.90	4.92	5.30	0.50	2.65	1.65	1.02	2.30	/	0.316	0.386	0.192	0.207	0.020	0.103	0.064	0.040	0.090	/
H2344	Silvery	16.30	25.55	11.92	7.35	0.90	3.85	2.05	/	5.00	/	0.636	0.996	0.465	0.287	0.035	0.150	0.080	/	0.195	/
H2354	Silvery	12.50	17.15	8.58	7.35	0.70	5.60	4.20	2.20	3.35	4.80	0.488	0.669	0.335	0.287	0.027	0.218	0.164	0.086	0.131	0.187
H2357	Silvery	12.50	17.40	9.60	7.49	0.64	4.63	3.35	1.75	3.40	5.00	0.488	0.679	0.374	0.292	0.025	0.181	0.131	0.068	0.133	0.195
H2361	Silvery	24.20	21.60	10.20	10.20	0.70	8.80	7.40	1.70	7.45	/	0.944	0.842	0.398	0.398	0.027	0.343	0.289	0.066	0.291	/
H2385	Silvery	10.95	17.10	11.40	6.50	0.80	6.26	4.66	4.60	4.00	/	0.427	0.667	0.445	0.254	0.031	0.244	0.182	0.179	0.156	/
H2391	Silvery	17.02	26.00	14.48	8.00	1.10	7.90	5.70	4.70	6.90	9.60	0.664	1.014	0.565	0.312	0.043	0.308	0.222	0.183	0.269	0.374
H2392	Silvery	19.35	18.75	10.50	6.10	0.80	5.40	3.80	1.00	2.54	/	0.755	0.731	0.410	0.238	0.031	0.211	0.148	0.039	0.099	/
H2393	Silvery	19.00	26.00	14.00	9.60	1.05	8.10	6.00	0.50	5.00	7.30	0.741	1.014	0.546	0.374	0.041	0.316	0.234	0.020	0.195	/
H2396	Silvery	25.00	18.70	7.70	7.00	1.00	5.90	3.90	2.30	4.90	/	0.975	0.729	0.300	0.273	0.039	0.230	0.152	0.090	0.191	/

# METAL U-TYPE NUT

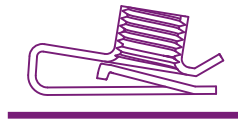

H1146

**Color:** Silvery Dacromet  
**Style:** Multi thread U-nut  
 Relief notch square turned up leg  
**Front bumper**



H2000

**Color:** Black Dacromet  
**Style:** Standard U-type nut  
 Center relief notch square turned up leg  
**Front head, splash guard**

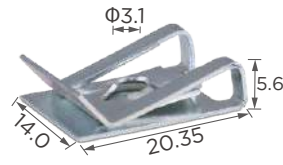

H2004

**Color:** Black Dacromet  
**Style:** Standard U-type nut  
 Twin prong impression no extrusion on leg  
**Panel**



H2006

**Color:** Black Dacromet  
**Style:** Standard U-type nut  
 Twin prong impression no extrusion on leg  
**Panel**



H2023

**Color:** Silvery Dacromet  
**Style:** Standard U-type nut  
 Relief notch turned up  
**Panel**



H2025

**Color:** Black Dacromet  
**Style:** Standard U-type nut  
 No retainer on lower leg  
**Panel**

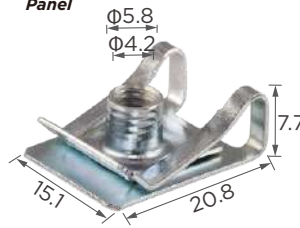

H2042

**Color:** Silvery Dacromet  
**Style:** Multi thread U-nut  
 Relief notch square turned up leg  
**Headlight, battery supply**



H2043

**Color:** Silvery Dacromet  
**Style:** Standard U-type nut  
 Center relief notch no extrusion on leg  
**Panel**



H2044

**Color:** Silvery Dacromet  
**Style:** Standard U-type nut  
 Twin prong impression no extrusion on leg  
**Panel**

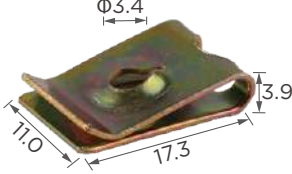

H2045

**Color:** Zinc  
**Style:** Standard U-type nut  
 Relief notch corner turned up leg  
**Panel**

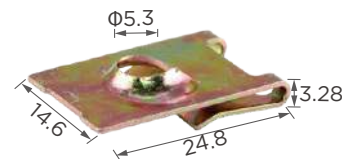

H2046

**Color:** Zinc  
**Style:** Standard J-type nut  
 Relief notch corner turned down lower leg  
**Panel**

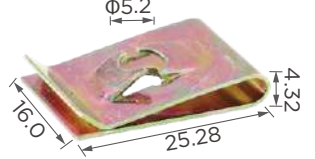

H2047

**Color:** Zinc  
**Style:** Standard U-type nut  
 Twin prong impression no extrusion on leg  
**Panel**

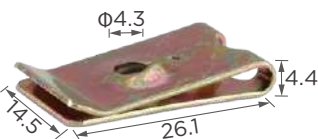

H2048

**Color:** Zinc  
**Style:** Standard U-type nut  
 Keyhole relief notch corner turned up  
**Panel**

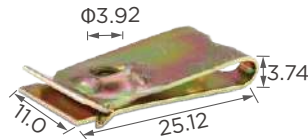

H2049

**Color:** Zinc  
**Style:** Standard U-type nut  
 Relief notch corner turned up leg  
**Panel**

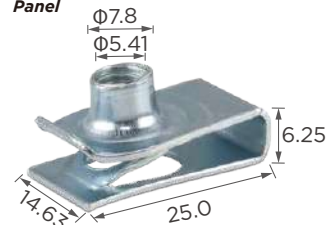

H2050

**Color:** Silvery Dacromet  
**Style:** Multi thread U-nut  
 Impression corner turned up leg  
**Fuel supply, oil cooler, splash guard**



H2051

**Color:** Black Dacromet  
**Style:** Multi thread U-nut  
 Impression square turned up leg  
**Panel**

## METAL U-TYPE NUT



H2079

**Color:** Black Dacromet  
**Style:** Multi thread U-nut  
 Impression square extrusion in lower leg  
**Panel**

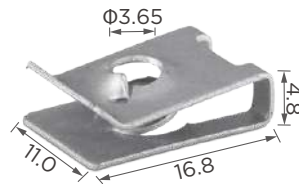

H2097

**Color:** Silvery Dacromet  
**Style:** Standard U-type nut  
 Relief notch corner turned up  
**Fog light, door sill**

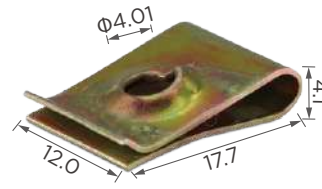

H2099

**Color:** Zinc  
**Style:** Standard U-type nut  
 Cone impression corner turned up  
**Panel**

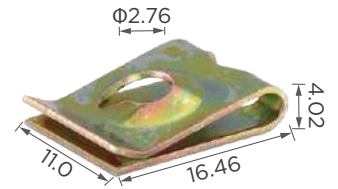

H2100

**Color:** Zinc  
**Style:** Standard U-type nut  
 Keyhole relief notch corner turned up  
**Panel**

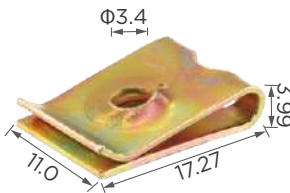

H2101

**Color:** Zinc  
**Style:** Standard U-type nut  
 Keyhole relief notch corner turned up  
**Panel**

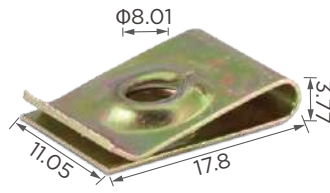

H2102

**Color:** Zinc  
**Style:** Standard U-type nut  
 Cone impression corner turned up  
**Panel**



H2121

**Color:** Black Dacromet  
**Style:** Multi thread U-nut  
 Impression square corner turned up  
**Fender, splash guard**



H2122

**Color:** Black Dacromet  
**Style:** Multi thread U-nut  
 Impression corner extrusion in lower leg  
**Spare tire**

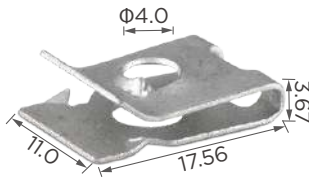

H2127

**Color:** Silvery Dacromet  
**Style:** Standard U-type nut  
 Cone impression corner turned up  
**Panel**



H2128

**Color:** Black Dacromet  
**Style:** Standard U-type nut  
 Relief notch square back turned up  
**Quarter fender**

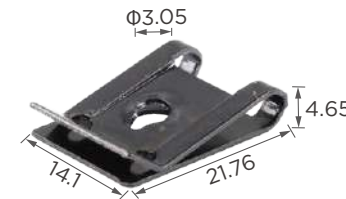

H2129

**Color:** Black Dacromet  
**Style:** Standard U-type nut  
 Relief notch corner back turned up  
**Panel**



H2146

**Color:** Silvery Dacromet  
**Style:** Multi thread U-nut  
 Relief notch corner turned up  
**Front bumper**



H2147

**Color:** Black Dacromet  
**Style:** Standard U-type nut  
 Cone relief notch square back turned up  
**Panel**



H2155

**Color:** Black Dacromet  
**Style:** Standard U-type nut  
 Keyhole relief notch square turned up  
**Rear bumper**



H2156

**Color:** Black Dacromet  
**Style:** Multi thread U-nut  
 Impression corner extrusion in lower leg  
**Panel**



H2157

**Color:** Silvery Dacromet  
**Style:** Standard U-type nut  
 Cone relief notch square back turned up  
**Under tray**

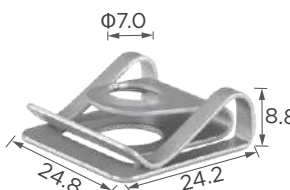

H2158

**Color:** Silvery Dacromet  
**Style:** Standard U-type nut  
 Cone relief notch square back turned up  
**Undertray**



H2159

**Color:** Silvery Dacromet  
**Style:** Multi thread U-nut  
 Impression corner extrusion in lower leg  
**Panel**

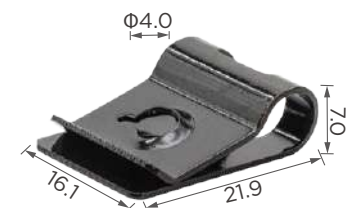

H2160

**Color:** Black Dacromet  
**Style:** Standard U-type nut  
 Keyhole relief notch corner turned up  
**Fender, spoiler**



H2171

**Color:** Silvery Dacromet  
**Style:** Standard U-type nut  
 Cone relief notch square back turned up  
**Front bumper**

# METAL U-TYPE NUT

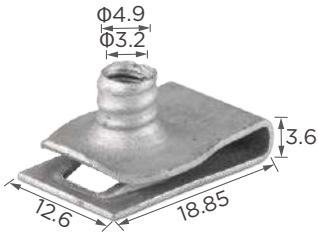

**H2184**

**Color:** Silvery Dacromet  
**Style:** Multi thread U-nut  
 Impression corner extrusion in lower leg  
*Rear bumper, fender, light*

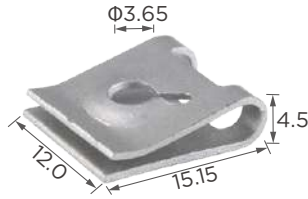

**H2188**

**Color:** Silvery Dacromet  
**Style:** Standard U-type nut  
 Keyhole relief notch corner turned up  
*Grille, splash guard*



**H2196**

**Color:** Black Dacromet  
**Style:** Multi thread U-nut  
 Impression corner turned up up leg  
*Front bumper, fan*



**H2198**

**Color:** Black Dacromet  
**Style:** Standard U-type nut  
 Twin prong impression no extrusion on leg  
*Front bumper*

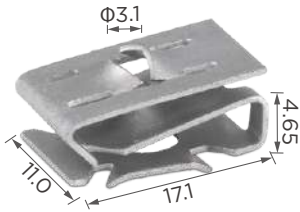

**H2203**

**Color:** Silvery Dacromet  
**Style:** Speed S-type nut  
 Twin prong impression  
*Heat shield, wheelarch, front bumper*

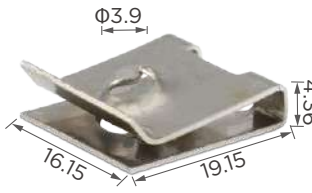

**H2204**

**Color:** Zinc  
**Style:** Standard U-type nut  
 Cone relief notch square back turned up  
*Splash guard, insulation*



**H2241**

**Color:** Black Dacromet  
**Style:** Standard U-type nut  
 Cone relief notch corner no extrusion leg  
*Panel*



**H2242**

**Color:** Black Dacromet  
**Style:** Standard U-type nut  
 Cone relief notch corner no extrusion leg  
*Panel*

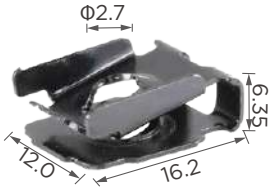

**H2244**

**Color:** Black Dacromet  
**Style:** Standard U-type nut  
 Cone relief notch square back turned up  
*Dashboard, console, splash guard*

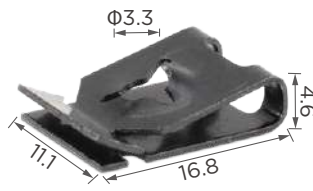

**H2245**

**Color:** Black Dacromet  
**Style:** Standard U-type nut  
 Relief notch corner no extrusion on leg  
*Heat shield, rocker panel*

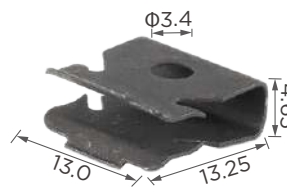

**H2248**

**Color:** Black Dacromet  
**Style:** Standard U-type nut  
 Impression square no extrusion on leg  
*Fog lamp, heat shield, front bumper*



**H2249**

**Color:** Silvery Dacromet  
**Style:** Standard U-type nut  
 Cone relief notch square back turned up  
*Grille, heat shield, front end*



**H2255**

**Color:** Silvery Dacromet  
**Style:** Multi thread U-nut  
 Impression square extrusion in lower leg  
*Splash guard, front bumper*



**H2285**

**Color:** Silvery Dacromet  
**Style:** Multi thread U-nut  
 Relief notch square back turned up  
*Panel*



**H2300**

**Color:** Silvery Dacromet  
**Style:** Multi thread U-nut  
 Relief notch corner turned up  
*Undertray, front end*

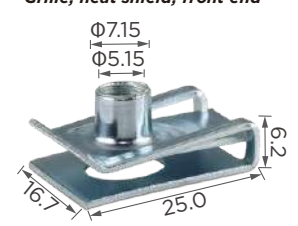

**H2305**

**Color:** Silvery Dacromet  
**Style:** Multi thread U-nut  
 Relief notch square back turned up  
*Panel*



**H2319**

**Color:** Silvery Dacromet  
**Style:** Standard U-type nut  
 Relief notch corner turned up leg  
*Heat shield, rear bumper*



**H2320**

**Color:** Silvery Dacromet  
**Style:** Standard U-type nut  
 Keyhole relief notch corner turned up  
*Fender, spoiler*



**H2323**

**Color:** Silvery Dacromet  
**Style:** Standard U-type nut  
 Cone relief notch square back turned up  
*Rear bumper*

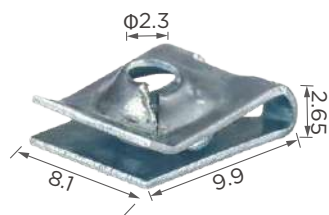

**H2341**

**Color:** Silvery Dacromet  
**Style:** Standard U-type nut  
 Keyhole relief notch corner turned up  
*Panel*



## METAL U-TYPE NUT

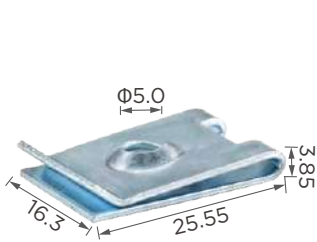

H2344

**Color:** Silvery Dacromet  
**Style:** Standard U-type nut  
 Keyhole relief notch corner turned up  
**Panel**

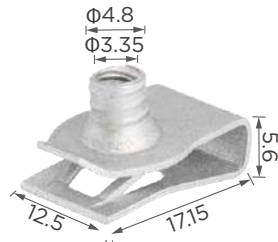

H2354

**Color:** Silvery Dacromet  
**Style:** Multi thread U-nut  
 Impression square extrusion in lower leg  
**Front bumper, undershield, dashboard**



H2357

**Color:** Black  
**Style:** Multi thread U-nut  
 Impression corner extrusion in lower leg  
**Panel**



H2361

**Color:** Silvery Dacromet  
**Style:** Standard U-type nut  
 Cone relief notch square back turned up  
**Engine compartment air duct**

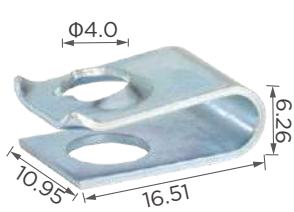

H2385

**Color:** Silvery Dacromet  
**Style:** Standard U-type nut  
 Cone impression corner turned up  
**Fender liner, undershield, mudguard**

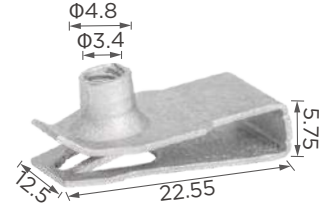

H2390

**Color:** Silvery  
**Style:** Multi thread U-nut  
 Impression square extrusion in lower leg  
**Front bumper, undershield**



H2391

**Color:** Silvery  
**Style:** Multi thread U-nut  
 Impression square extrusion in lower leg  
**Steering system, rear bumper**

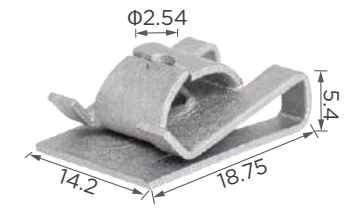

H2392

**Color:** Silvery  
**Style:** Standard U-type nut  
 Cone relief notch square back turned up  
**Front and rear bumper, fender liner**



H2393

**Color:** Silvery  
**Style:** Multi thread U-nut  
 Relief notch square back turned up  
**Fender, engine oil connector**

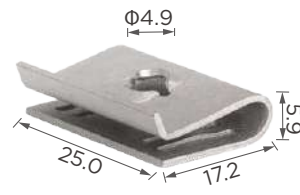

H2396

**Color:** Silvery  
**Style:** Standard U-type nut  
 Cone relief notch square back turned up  
**Fender liner**

## SPECIALIZED METAL CLIP

### 01. Bumper & Grille Iron Sheet

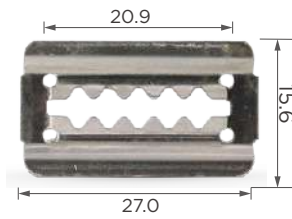

**C0322**  
**Material:** Metal  
**Color:** Silvery Dacromet  
**Front and rear bumper**

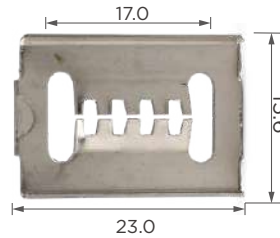

**C0551**  
**Material:** Metal  
**Color:** Silvery Dacromet  
**Rear bumper, grille**

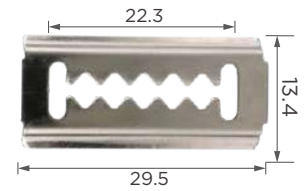

**C0984**  
**Material:** Metal  
**Color:** Silvery Dacromet  
**Front and rear bumper**

### 02. Brake Anti-rattle Spring

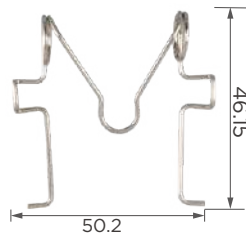

**H2161**  
**Material:** Metal  
**Color:** Silvery Dacromet  
**Clip**

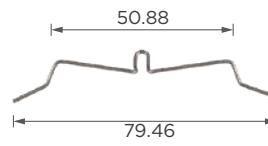

**H2162**  
**Material:** Metal  
**Color:** Silvery Dacromet  
**Clip**

### 03. Door Lock Rod clip

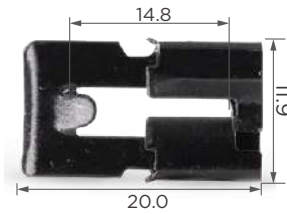

**C0357**  
**Material:** Metal  
**Color:** Black Dacromet  
**Door panel**

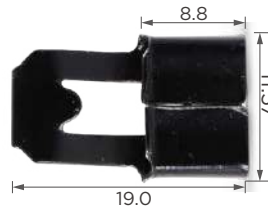

**C0525**  
**Material:** Metal  
**Color:** Black Dacromet  
**Door panel**

### 04. Lock Nut

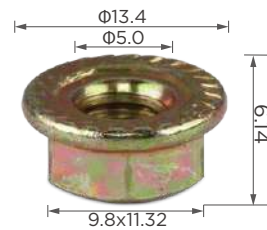

**H2068**  
**Material:** Metal  
**Color:** Zinc  
**Flange lock nut**

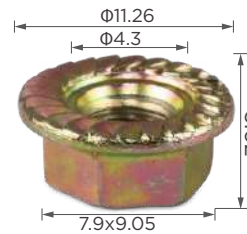

**H2114**  
**Material:** Metal  
**Color:** Zinc  
**Spin lock nut**

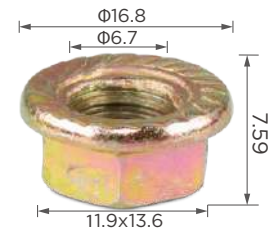

**H2115**  
**Material:** Metal  
**Color:** Zinc  
**Spin lock nut**

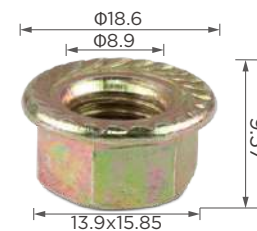

**H2138**  
**Material:** Metal  
**Color:** Zinc  
**Vent-pipe**



## SPECIALIZED METAL CLIP

### 05. Axle Shaft C-Clip



C0697

**Material:** Metal  
**Color:** Silvery Dacromet  
**Axle shaft**



C0698

**Material:** Metal  
**Color:** Silvery Dacromet  
**Axle shaft**

### 06. Rear Brake Pad



H2144

**Material:** Metal  
**Color:** Silvery Dacromet  
**Rear brake fitting**



H2145

**Material:** Metal  
**Color:** Silvery Dacromet  
**Rear brake fitting**

### 07. Edge Clip



C0323

**Material:** Metal  
**Color:** Bronze Dacromet  
**Front bumper**



H2224

**Material:** Metal  
**Color:** Black Dacromet  
**Side moulding, rocker panel**



H2298

**Material:** Metal  
**Color:** Black Dacromet  
**Clip**

### 08. S-Clip



H2003

**Material:** Metal  
**Color:** Black Dacromet  
**Door panel, rear tray**

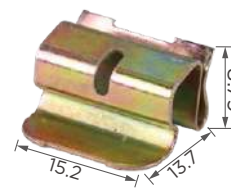

H2036

**Material:** Metal  
**Color:** Zinc  
**Clip**

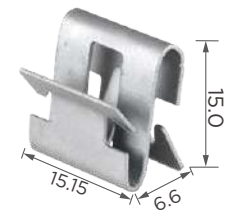

H2149

**Material:** Metal  
**Color:** Silvery Dacromet  
**Clip**

### 09. Nut & Screw



H2035

**Material:** Metal  
**Color:** Silvery & Black Dacromet  
**U-nut & screw**



H2098

**Material:** Metal  
**Color:** Silvery Dacromet  
**U-nut & screw**



H2179

**Material:** Metal  
**Color:** Silvery Dacromet  
**Screw & nut**

## SPECIALIZED METAL CLIP

### 10. Quarter Turn Clip

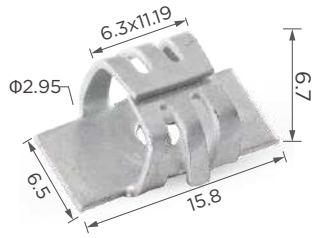

C0588

**Material:** Metal  
**Color:** Silvery Dacromet  
**Front bumper, radiator, grille, front frame**



H2002

**Material:** Metal  
**Color:** Silvery Dacromet  
**Door panel, dashboard, console**

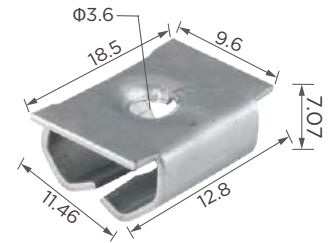

H2026

**Material:** Metal  
**Color:** Silvery Dacromet  
**Engine compartment panel**

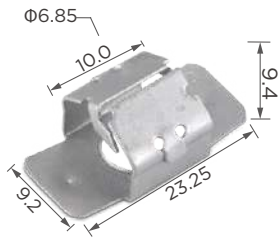

H2176

**Material:** Metal  
**Color:** Silvery Dacromet  
**Front bumper, seat**

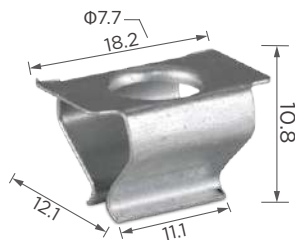

H2027

**Material:** Metal  
**Color:** Silvery Dacromet  
**Rear bumper, spare wheel tray**



H2185

**Material:** Metal  
**Color:** Silvery Dacromet  
**Air duct, rear bumper**



H2200

**Material:** Metal  
**Color:** Silvery Dacromet  
**Fender**

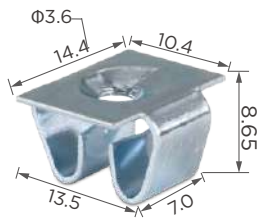

H2246

**Material:** Metal  
**Color:** Silvery Dacromet  
**Insulation panel**



H2286

**Material:** Metal  
**Color:** Silvery Dacromet  
**Clip**

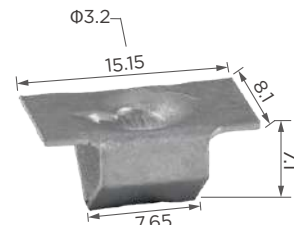

H2295

**Material:** Metal  
**Color:** Silvery Dacromet  
**Door window**



H2382

**Material:** Metal  
**Color:** Silvery  
**Door panel trim**

### 11. Rivetted Cap Nut



H2191

**Material:** Metal  
**Color:** Blue Dacromet  
**Clip**



H2247

**Material:** Metal  
**Color:** Black Dacromet  
**Front and rear bumper, dashboard**

### 12. Washer-type Self-Threading Nut



H2222

**Material:** Metal  
**Color:** Silvery Dacromet  
**Rear bumper**

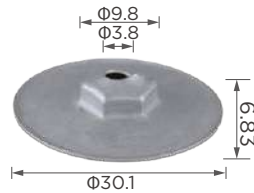

H2312

**Material:** Metal  
**Color:** Silvery Dacromet  
**Heat shield**

## SPECIALIZED METAL CLIP

### 13. Dowel Pin



H2301

**Material:** Metal  
**Color:** Black Dacromet  
**Panel**



H2302

**Material:** Metal  
**Color:** Silvery Dacromet  
**Engine splash shield**



H2309

**Material:** Metal  
**Color:** Black Dacromet  
**Engine splash shield, front bumper**



H2342

**Material:** Metal  
**Color:** Black Dacromet  
**Under Engine cover**



H2377

**Material:** Metal  
**Color:** Black Dacromet  
**Under heat shield**

### 14. Other Metal Clip

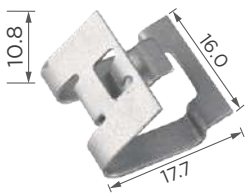

H1118

**Material:** Metal  
**Color:** Silvery Dacromet  
**Front and rear bumper, Splash guard**



H2001

**Material:** Metal  
**Color:** Silvery Dacromet  
**Side moulding, fender flare, spoiler**



H2089

**Material:** Metal  
**Color:** Silvery Dacromet  
**Under shield**



H2090

**Material:** Metal  
**Color:** Black Dacromet  
**Brake hose**



H2091

**Material:** Metal  
**Color:** Silvery Dacromet  
**Brake and clutch pedals**



H2140

**Material:** Metal  
**Color:** Silvery Dacromet  
**Front bumper**

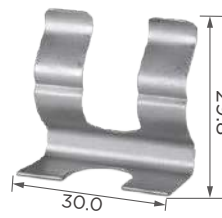

H2148

**Material:** Metal  
**Color:** Silvery Dacromet  
**Clip**



H2151

**Material:** Metal  
**Color:** Black Dacromet  
**Door panel**

## SPECIALIZED METAL CLIP

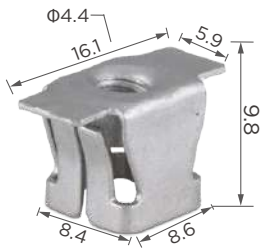

H2154

**Material:** Metal  
**Color:** Silvery Dacromet  
**Grille, liftgate, heat shield, fender**



H2199

**Material:** Metal  
**Color:** Black Dacromet  
**Clip**

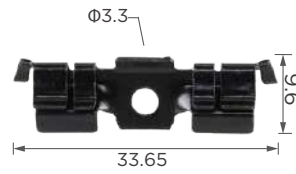

H2219

**Material:** Metal  
**Color:** Black Dacromet  
**Roof moulding**

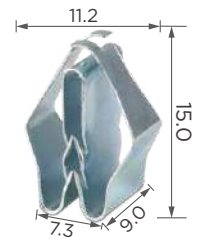

H2234

**Material:** Metal  
**Color:** Silvery Dacromet  
**Dashboard**



H2297

**Material:** Metal  
**Color:** Black Dacromet  
**Clip**



H2307

**Material:** Metal  
**Color:** Silvery Dacromet  
**Front bumper**

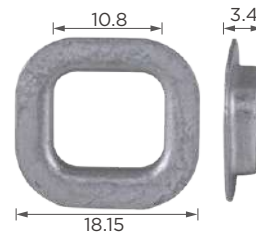

H2314

**Material:** Metal  
**Color:** Silvery Dacromet  
**Front bumper**

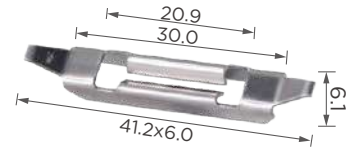

H2315

**Material:** Metal  
**Color:** Silvery Dacromet  
**Front and rear bumper**



H2322

**Material:** Metal  
**Color:** Silvery Dacromet  
**Wheelarch, front bumper, under shield**

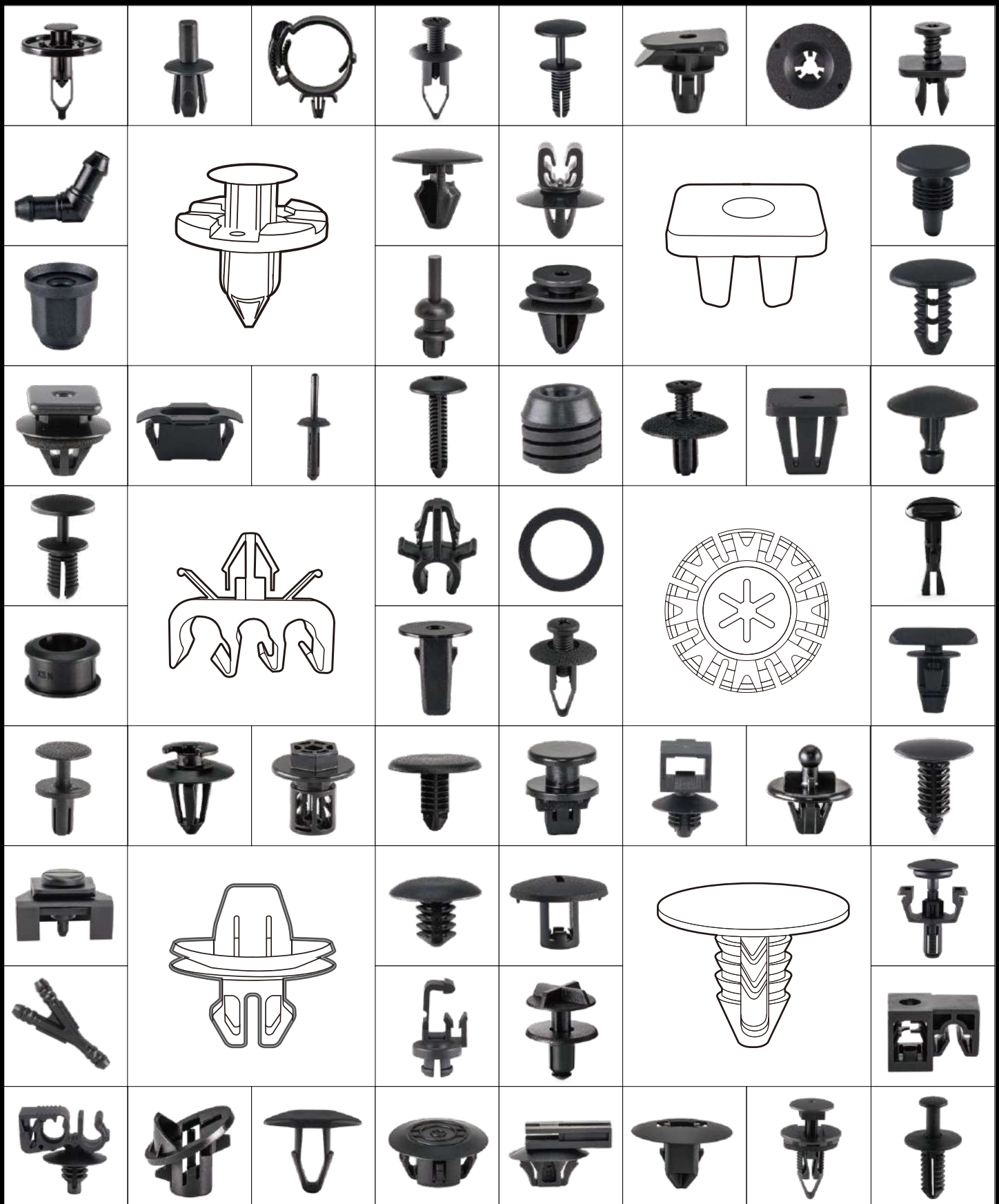

Contactos:  
+351 919732700

Email:  
Info@toolsystem.pt

Website:  
www.toolsystem.pt

Morada:  
Rua Bartolomeu Dias, Loja 2  
2910-419 Setúbal